

# HITACHI

## SERVICE MANUAL

### PAL / SECAM / NTSC



HITA-02947

YS

No. 04001

C2178FS	- 191L
	- 192
C2176PX	- 981
C2173MS	- 191/L
	- 192/R
	- 981
C2172MS	- 191/L
	- 192/R
	- 981R

## S3 Chassis

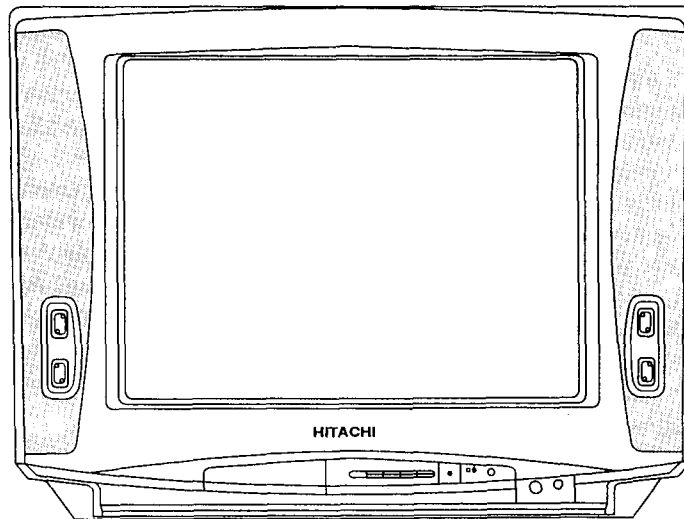

**CAUTION :** Before servicing this chassis, it is important that the service technician reads the "Safety Precaution" and "Product Safety Notices" in this Service Manual.

### CONTENTS

SAFETY PRECAUTIONS	2	HORIZONTAL CENTER POSITION ADJUSTMENT	9
PRODUCT SAFETY NOTICE	2	VERTICAL AMPLITUDE ADJUSTMENT	10
SPECIFICATIONS	2	ADJUSTMENT POINT	10
CONTROLS	3	BASIC CIRCUIT DIAGRAM	11
REMOTE CONTROL UNIT	3	PRINTED WIRING BOARD	17
CIRCUIT DESCRIPTION	4	WAVEFORMS	18
PRINTED WIRING BOARD - BLACK/WHITE P in P	7	WIRING DIAGRAM	19
PI F CARRIER FILTER ADJUSTMENT	8	REPLACEMENT PART LIST	23
+B ADJUSTMENT	8		
AGC ADJUSTMENT	9		

SPECIFICATIONS AND PARTS ARE SUBJECT TO CHANGE FOR IMPROVEMENT.

## COLOR TELEVISION

FEBRUARY 1998

PT. HITACHI CONSUMER PRODUCTS INDONESIA

## SAFETY PRECAUTIONS

**WARNING :** The following precautions should be observed.

1. Do not install, remove, or handle the picture tube in any manner unless shatter proof goggles are worn. People not so equipped should be kept away while picture tubes are handled. Keep the picture tube away from the body while handling.
2. When service is required, an isolation transformer should be inserted between power line and the receiver before any service is performed on the chassis.
3. When replacing the chassis in the cabinet, ensure all the protective devices are put back in place, such as barriers, non-metallic knobs, adjustment or compartment covers or shields, isolation resistors/capacitors, etc.
4. When service is required, observe the original lead dressing. Extra precaution should be taken to assure correct lead dressing in the high voltage circuitry area. particularly note the R. G. B. lead dressing. Ensure they are dressed well away from the horizontal scan and F. B. T. circuitry.
5. Always use the manufacturer's replacement component. Always replace original spacers and maintain lead lengths. Especially critical components are indicated thus  $\Delta$  on the parts list and should not be replaced by other makes. Furthermore, where a short circuit has occurred, replace those components that indicate evidence of overheating.
6. Before returning a serviced receiver to the customer, the service technician must thoroughly test the unit to be certain that it is completely safe to operate without danger of electrical shock, and be sure that no protective device built into the instrument by the manufacturer has become defective, or inadvertently damaged during servicing. Therefore, the following checks are recommended for the continued protection of the customers and service technicians.

## INSULATION

Insulation resistance should not be less than 10M $\Omega$  at 500V DC between the mains poles and any accessible metal parts. Also, no flashover or breakdown should occur during the dielectric strength test, applying 3kV AC or 4.25kV DC for two seconds between the main poles and accessible metal parts.

## Specifications

Reception system	625-lines	B G//D K/H PAL B G/D K/K1 SECAM NTSC50	Aerial input	75 $\Omega$ unbalanced type
	525-lines (M/NTSC) NTSC3 58-5.5/6.0/6.5 <sup>*)</sup> NTSC4 43-5.5/6.0/6.5 PAL 60 NTSC3 58 (VIDEO)		Color picture tube	A51KPD12XX
			Speaker	12 cm X 6 cm (X2)
			Sound Output (Max)	5 W x 2
			Power supply	AC 110-230V, 50/60HZ
Channel coverage (Frequency range 44MHz ~ 404MHz 407MHz ~ 868MHz)	CCIR	: E2-12, E21-69, SO1-3, S1-10, S11-20, S21-41	Power consumption	92 W
	OIRT	: R1-12, R21-69	Weight (kg)	21.5
	JAPAN	: J1-12, J13-62	Dimensions W x H x D (cm)	61 0 X 46 0 X 47 0
	U.S.A	: US2-13, JW, US14-69		
Hong Kong, U.K.	: UK21-69			
China	: C1-12, C13-57			

(<sup>\*)</sup> Only for C2178FS/2176PX

\* Specification are subject to change without notice to improve performance

## HIGH VOLTAGE

High voltage should always be kept at the rated value of the chassis and no higher. Operating at higher voltages may cause a failure of the picture tube or high voltage supply, and also, under certain circumstances could produce X-radiation moderately in excess of design levels. The high voltage must not, under any circumstances, exceed 28kV on the chassis.

## X-RADIATION

**TUBES:** The primary source of X-radiation in this receiver is the picture tube. The tube utilised for the above mentioned function in this chassis is specially constructed to limit X-radiation.

For continued X-radiation protection, replace tube with the same type as the original HITACHI approved type.

## PRODUCT SAFETY NOTICE

Many electrical and mechanical parts in HITACHI television receivers have special safety related characteristics. These characteristics are often not evident from visual inspection, nor can the protection afforded by them necessarily be obtained by using replacement components rated for higher voltage, wattage, etc. Replacement parts which have these special safety characteristics are identified by marking with a  $\Delta$  on the schematics and replacement parts list in this Service Manual. The use of a substitute replacement component which does not have the same safety characteristics as the HITACHI recommended replacement one, shown in the parts list in this Service Manual, may create electrical shock, fire, X-radiation, or other hazards.

Product Safety is continuously under review, and new instructions are issued from time to time. For the latest information, always consult the current HITACHI Service Manual. A subscription to, or additional copies of HITACHI Service Manuals, may be obtained at a nominal charge from your HITACHI SALES CORPORATION.

## TUBE DISCHARGE

The line output stage can develop voltages in excess of 25kV; if the E. H. T. cap is required to be removed, discharge the anode cap to chassis via a high value resistor, prior to its removal from the tube.

# CONTROLS

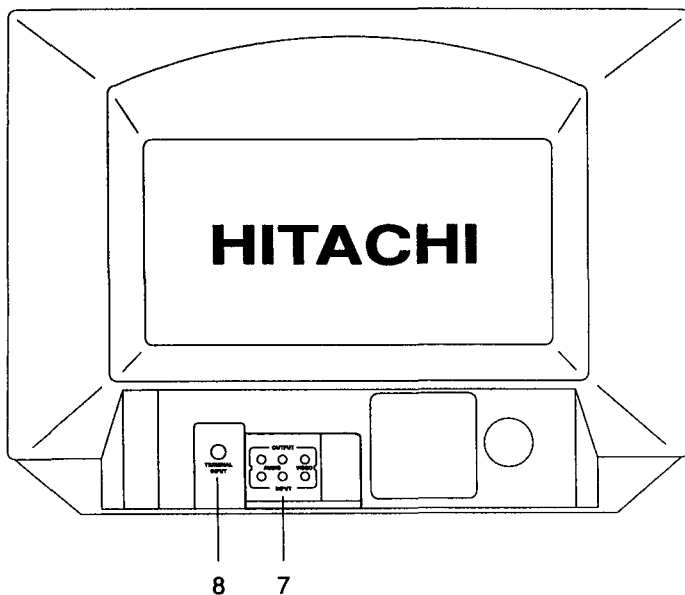
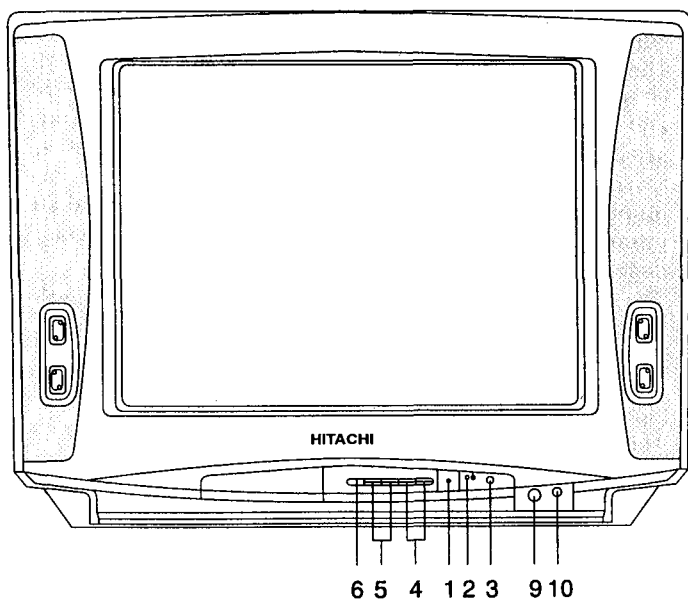

1	Power ON/OFF switch
2	Power indicator
3	Remote control receiver
4	Programme up/down
5	Volume up/down
6	Input selection
7	AV in/out terminals
8	Aerial input terminal
9	MIC terminal (C2178FS only)
10	MIC Volume control (C2178FS only)

Remote control transmitter  
Names of each button

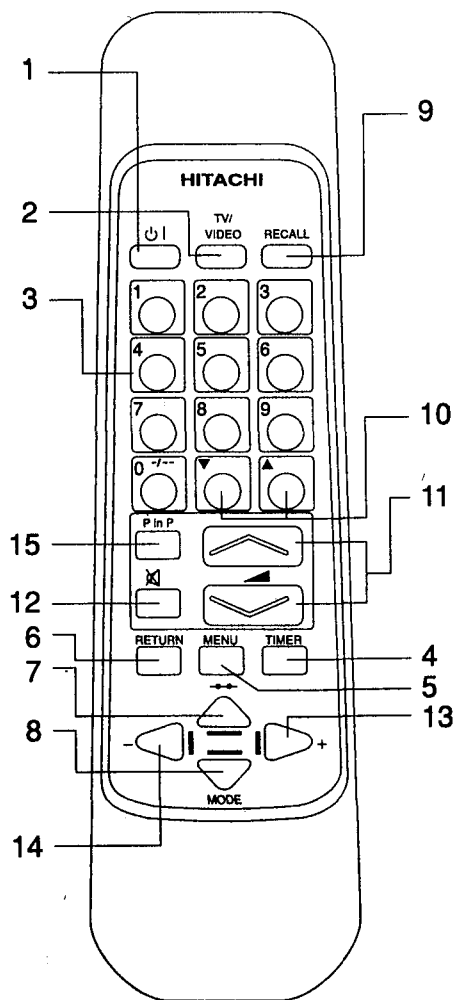

1	Power ON/OFF switch
2	Input select
3	Programme selector
4	Timer
5	Menu
6	Return
7	Normalize (Red)
8	Mode (Green)
9	Recall
10	Programme up/down
11	Volume up/down
12	Mute
13	Up (Blue)
14	Down (Yellow)
15	P in P

## CIRCUIT DESCRIPTION

### Tuner and I.F. Stages :

The tuner used on this chassis, is powered by the +9V, supply, and covers VHF, UHF, and CATV Hyper Band. The I.F. output from the tuner is applied to amplifier Q201 then selected with the mode shown in Table 1 and input to CP201 or CP202 (CMT2198/2196 ONLY).

### Sound I.F. Stages :

The sound stages consist of IC201, which is basically a demodulator, and IC402, which is the audio controller and IC4501, which is the output amplifier.

The I.F. signal at the collector of Q201, is fed via filter CP201 or CP202\*1 and input to IC201 at pins 45 and 46. The composite signal output from pin 7 of IC201 is input to sound filters MF401\*1, MF402, MF403 and MF404, and selected with the mode shown in Table 1 at IC451 after being output from the filter. The selected signal is then input to pin 5 of IC201 via C422.

Demodulation is then performed by the IC, with the sound output being obtained from pin 1. This sound signal is controlled by IC402. It is then input to pins 2,5 of IC4501 via C408, C409 for further amplification, and output to the speaker from pins 7, 12.

Volume control is performed by the DC voltage applied to pin 5 of IC201. This is obtained via R427 from pin 8 of IC1101. Sound demodulation output at pin 1 of IC201, is applied to the terminal of rear via Q401. From the output terminal, the audio signal can be output to external equipment if desired.

Audio signals from external equipment can be applied to the input terminal of rear. They are then input to IC402 at pins 1 and 22. When connecting audio signals this way, a "Low" is applied to pin 4 of IC402 from IC1101, thereby changing the internal switching circuitry of the IC. Volume control of the external audio signal is then obtained in the same way as internal sound i f by the voltage at pin 5 of IC201.

Table 1

B-G/D-K	M/I	Saw filter	Sound filter	Sound trap
L	H	CP201	MF402 (5.5MHz)	MF501/ MF502
H	L		MF403 (6.0MHz)	
L	L		MF404 (6.5MHz)	
H	H	CP202	MF401 (4.5MHz)	MF503

### Vision I.F. Stages :

The I.F. signal from CP201 and CP202 is input to pins 45 and 46 of IC201. These pins supply an internal amplifier consisting of three stages whose gain is controlled by the AGC circuit. The response speed of this internal AGC stage is determined by the external components connected to pin 48.

The output from the I.F. amplifier is then fed to the video detector circuitry. The picture carrier is limited and phase shifted by the tank circuitry of L202 etc., connected between pins 2 and 3 of the IC. This produces a reference frequency which is utilized for synchronous video detection.

An RF AGC voltage is made available at pin 48 of IC201, the starting level of which is determined by the voltage applied to pin 49, which in turn is fixed by the setting of VR202. This AGC voltage is then fed to the tuner via R208 to control its gain accordingly.

The composite video finally emerges at pin 7 of IC201.

**\*1 ONLY FOR C2178FS/2176PX**

### Luminance Circuitry :

The composite video signal output from pin 7 of IC201 is applied to the sound rejection filter MF501, MF502, and MF503\*1. MF501, MF502 and MF503\*1 are selected with the mode shown in Table 1. The resulting luminance signal is applied to the terminal of rear, for output to external equipment if desired. It is then returned to pin 13 of IC201 via Q506, for color decoding and deflection synchronization.

The luminance signal is added internally to the R.G.B. matrix circuits of IC201, as well as being controlled by the brightness, contrast, and blanking stages of the IC. The luminance signal finally emerges with the R.G.B. signals from pins 18, 19 and 20 of IC201.

The voltages to control the contrast and brightness levels are output from pins 3 and 4 of IC1101, then applied to pins 17 and 25 of IC201.

An automatic beam current circuit is employed on this chassis. Should the beam current start to rise, the voltage at pin 4 of the flyback transformer will fall. This fall is applied to the cathode of D758, then via R760 to pin 25 of IC201, thereby reducing the contrast level and hence the beam current.

Video inputs from external equipment connected to the terminal of rear, are fed to IC201 pin 15.

When the external mode is selected, a "High" is applied to pin 16 of IC201.

### Chrominance Circuitry :

IC201 is designed to demodulate PAL, NTSC and SECAM systems. And this IC can distinguish between PAL, NTSC or SECAM signals. The demodulated colour signals are output from IC201 pins 30 and 31 as the R-y and B-y signals, then fed to pins 14 and 16 of IC501 which is a switch capacitor delay line.

IC201 allows bi-directional communication between the SECAM decoder IC502 and automatic system manager for SECAM identification. It delivers the VCXO (voltage controlled xtal oscillator) reference frequency (4.43MHz only) to the SECAM decoder via pin 32 of IC201. Once SECAM is identified, the gated reference signal is output to pin 32 of IC201.

The inputs at pins 14 and 16 are clamped, then fed via a buffer stage to internal delay lines, which are driven by a clock signal of 3MHz to obtain a delay period of 640 Seconds. This internal clock is generated from a 6MHz voltage controlled oscillator, and line locked by the sandcastle pulse input at pin 5. Low pass filters after the delay line stages suppress the clock signals.

The undelayed and the delayed signals are then added, with the resulting R-y and B-y signals being output from pins 11 and 12 via an internal buffer stage.

These outputs are then fed to IC201 at pins 28 and 29. This IC contains clamping circuits, and a DC colour saturation control, the level of which is set by the voltage applied to pin 26 from pin 5 of IC1101. The signals are then applied to a MATRIX circuit, and finally emerge from pins 18, 19 and 20 as the blue, green, and red signals.

### Deflection Circuits:

The deflection circuitry of IC201 contains a sync, separator stage, horizontal oscillator and output stages, a vertical count-down and output stage.

### Horizontal Stage :

The composite video signal from pin 7 of IC201 is returned to pin 13 via C302 as explained previously. This input is applied to the internal sync. separator stages of the IC.

A internal phase detector stage is provided with a sawtooth waveform, generated from the line pulse input to pin 38. The phase detector will then compare this sawtooth waveform to the sync. pulse. Any frequency drift will cause a corrective output to be applied to the horizontal oscillator, thereby maintaining the desired phase relationship.

The components connected to pin 40 form a filter network for the phase detector, and VR701/connected to pin 39 provides manual phase control. The horizontal output emerges at pin 37 and is then applied to the base of line drive transistor Q721, T721 couples the output of Q721 to the line output transistor Q781. Both these transistors are powered by the 95V supply. A line pulse available at pin 6 of the flyback transformer is rectified by D751, smoothed by C756 and provides approximately 170V to drive the output transistor Q851, Q852, Q853. Under certain fault conditions, i.e. increased H.T. supply, low line oscillator frequency, or reduced value of the tuning capacitor C781, an excess of E.H.T. could be developed. To prevent this happening, the rectified voltage of D751 is fed via potential divider R757, R758, and applied to ZD751. Should the E.H.T. rise excessively, the threshold of the zenner will be exceeded, and a voltage will be applied to pin 35 of IC1101 via R1106, thereby shutting down the power circuit. This effectively applies a "Low" to Q954 base, turning the transistor off. Consequently, Q953 will be turned off, and the +8V supply to IC201 is then removed, thereby shutting down the deflection stages of the IC, preventing further E. H. T. generation.

Excessive beam current can also occur under certain fault conditions, so this is prevented in the following manner.

The H.T. current to the horizontal output stages is measured by R781.

Should the current rise, the voltage drop across R781 will increase, and a voltage will be applied to the gate of Q955. This will then prevent further E.H.T. generation as described earlier.

A supply of +25V is required for IC681. This is obtained from pin 1 of the flyback transformer, and smoothed by C754.

### Vertical Stages :

The internal vertical sync. of IC201 is fed to a triggered vertical divider stage, which counts down the horizontal frequency to obtain the vertical frequency, thereby eliminating the need for a conventional oscillator circuit.

This also has the advantage that no external frequency control is required.

C601 at pin 42 of the IC is used for ramp generation, and produces the required sawtooth output.

The vertical output from pin 43 of IC201 is applied to pin 4 of IC681 via R604. The components D601 and C605 determine the flyback generations time, and the vertical output to drive the deflection coils is made available from pin 2.

The deflection current that occurs at the junction of R609, is added to the feedback from R607/C608 etc. and the result is applied to pin 41 of IC201. The values of R607 and C608 determine the linearity, whilst VR601 sets the vertical height.

### Power Supply Circuit :

#### (1) Starting operation

- Power switch S901 turned ON → Rectified at D901-D904 → Voltage at Q903 base rises → First Switching pulse generated at winding (P1-P2) of T901 → Drive voltage → Provide to Q905 of winding (B1-B2) of T901 → Q905 supply stable drive current to Q903 base → come into normal operation.

#### (2) Switching constant voltage operation

- AC input voltage rises or +B load decreased (picture gets dark) → +B (95V) rises → Ic increased at Q951 → Id increased at IC901 → Ic increased at IC901 → Voltage decreased at pin ⑤ of IC901 → ON period of Q901 increased → ON period of Q903 decreased → Positive voltage of D951 anode decreased → +B voltage falls → +B voltage stabilized.

#### (3) Standby operation

- Remote control power OFF → IC1101 ② and ③ → Q954 OFF → Q953 OFF → IC201 H. Start Pin ⑥ stopped → Horizontal deflection stopped.
- ★ Also → Q952 OFF → R965 connect into R964 → Voltage of Q951 base rises → ON period of Q903 is slightly decreased by IC901 → +B voltage falls (about 62V) → Power consumption decreased. +5V power provided from T901 (S3-S4) winding through D952 and C954 → 5V at pin ⑦ of IC1101 stabilized by ZD1101.

### **Remote Control and Tuning Circuitry :**

The remote control receiving unit CP1201, contains an infrared amplifier and powered by the +5V supply, which is stabilized by ZD1101. The output from pin 2 of this unit is applied to pin 16 of IC1101.

This IC type M37210M4, performs channel selection, UP/DOWN analogue control, screen display, search tuning, controls inputs and search tuning, and controls inputs and outputs to and from the AV terminal.

IC1102 is the memory IC, which stores the data relating to the above functions, then transfers that information to IC1101 when required. Both these ICs are powered by the +5V supply.

X1101 supplies IC1101 with a basic clock frequency which controls all operating mode requirements.

When the TV is first switched on, IC1101 must be initially reset, and this is achieved by IC1101 stage. As the +5V supply begins to rise from switch on, pin 3 of Q1105 is held "Low". This is applied to pin 30 of IC1101 thus resetting the IC. Once pin 1 of Q1105 has almost reached its +5V potential, the "Low" is removed from pin 3 thus releasing the reset condition.

When the search routine has been initiated and a signal has been located, pin 14 of IC201 will become "High". This is applied to pin 34 of IC1101, and informs the IC that a signal is present. The search routine then stops, and the IC will monitor the AFC signal present at pin 15 to obtain the optimum signal.

Pins 46 and 47 control the signal system.

Contrast, colour, brightness, sharpness, tint, and volume are all controlled from the remote controls handset (the volume can also be adjusted by + and - buttons on the front of the TV), and will produce DC level changes from pins 3-8 of IC1101, which are then fed to the relevant pins of IC201.

Pins 31-32, 37-39, and 11 from the in and out matrix are for the front control operations.

Pins 12 and 13 are the clock and data output pins. These signals are supplied to the memory IC1102.

It is supplied to pin 16 of IC201. When "High" the IC will process external inputs applied to pins 13 and 15, and when "Low" the internal signals are processed.

The handset button marked TV/VIDEO will need to be pressed. This will then produce the required "High" from pin 20 to achieve the necessary switching, as explained earlier. The red, green and blue on-screen display signals are output from pins 50, 51 and 52. The components L1102, C1102, and C1103, on pins 28 and 29, determine the display oscillator frequency. The horizontal and vertical inputs at pins 1 and 2 determine the actual position of the on screen display. When a command requiring an on-screen display is received by IC1101, a "High" will be output from pin 49.

This is applied to pin 21 of IC201, and blanks out a portion of the picture. The on-screen display information is then inserted into this portion, thus resulting in a clear display. When the ALARM mode has been set, and the time input has elapsed, an output is obtained from pin 45 of IC1101.

This is then applied via R1184, R1119, C1111, R1118 etc. to pins 2 and 5 of IC4501 thus causing a "Bleep" sound to be heard.

Once the "OFF" timer mode has been set, the time input has elapsed, pins 21 and 22 of IC1101 output a "Low". This removes the supply to the base of Q903, and as a result the +9V output of Q902 disappears. This places the TV into its standby mode of operation by removing E.H.T. generation as explained previously.

When the "ON" time has been estimated and set, the standby command must be transmitted by the handset, to place the TV into its standby mode. As an indication that the standby mode is only temporary, pin 20 of IC1101 is taken "High" and "Low" alternately, causing D1114 to flash on and off.

When the entered time has elapsed, the "Low" outputs from pins 21 and 22 of IC1101 are removed, and the TV will return to normal operation.

## PRINTED WIRING BOARD

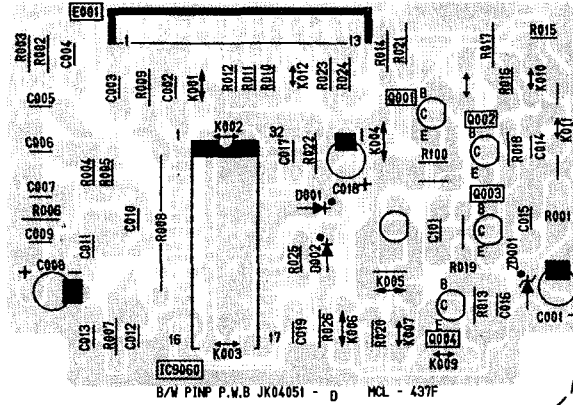

B/W PinP P.W.B. (C2178FS/C2173MS only)

## BLACK & WHITE PinP

The following block diagram shows the B/W PinP circuitry.

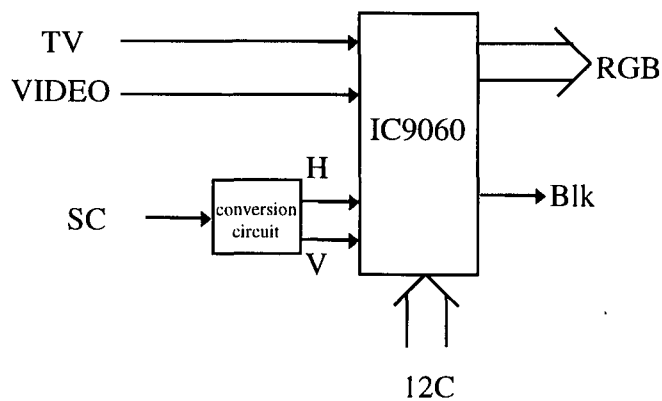

The video & TV signals are injected into the IC9060 where it is synchronised using the H & V signals generated by the SC signals. Either the video/TV signals will be selected through the 12C bus and output as RGB and blanking signals which are then applied to the I201.

## P. I. F. CARRIER FILTER ADJUSTMENT

### ADJUSTMENT LOCATION L202

Preparations for adjustment	Adjustment Procedure	Remarks/Waveform
<p>(1) Apply the following signal across IF out and GND of tuner.</p> <div style="text-align: center;"> </div> <p>SIGNAL LEVEL : -10-0dBm SIGNAL : PHILIPS PATTERN</p> <p>(2) Connect the oscilloscope to the pin (44) of IC201.</p> <p>(3) Supply DC voltage as below.</p> <div style="text-align: center;"> </div> <p>Delay time : More than 0.1sec.</p>	<p>(1) Adjust L202 until a "Fast rate of charge" is seen on voltmeter. Then adjust L202 to obtain reading on voltmeter as below.</p> <div style="text-align: center;"> <p><math>4.3 \pm 0.2V</math></p> </div>	<div style="text-align: center;"> </div>

## +B ADJUSTMENT

### ADJUSTMENT LOCATION R963 (VR 951)

Preparation for adjustment	Adjustment Procedure	Remarks/Waveform
<p>(1) AC input voltage <math>220 \pm 5V/50HZ</math></p> <p>(2) Turns on the set and set the brightness and contrast to max (SIGNAL PHILIPS PATTERN)</p> <p>(3) After 30 sec heat-run, check &amp; adjust the +B voltage.</p> <p><u>Measuring Point:</u></p> <p>+B voltage C956 + side GND C956 - side</p>	<p>(1) Adjust R963 (VR 951) to obtain +B voltage as below +B voltage = <math>95 \pm 0.3V</math></p>	



## AGC ADJUSTMENT

### ADJUSTMENT LOCATION VR202

Preparations for adjustment	Adjustment Procedure	Remarks
<p>1 With the signal received, apply heat run for more than two minutes to avoid the influence of circuit temperature drift.</p> <p>2 Connect the voltmeter of at least 100kΩ internal impedance to the AGC terminal of the tuner.</p>	<p>1 Received following channel and strength.</p> <p style="margin-left: 20px;">CHANNEL : CCIR 5 STRENGTH : -49dBm</p> <p>Adjust VR202 until the following voltage is reached.</p> <p style="margin-left: 20px;">V1 = (0.5 ± 0.2v)</p> <p>2 V1: the voltage without signal</p>	

## HORIZONTAL CENTER POSITION ADJUSTMENT

### ADJUSTMENT LOCATION VR701

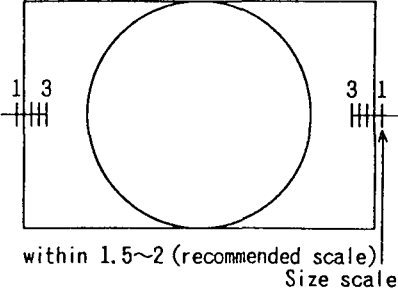
Preparations for adjustment	Adjustment Procedure	Remarks
<p>1 Receive the circle pattern signal.</p> <p>2 Set the brightness and contrast VRs to maximum.</p>	<p>1 Turn VR701 (H.Phase) and adjust so that size scales on the left and right are equal. (Refer to Fig. 3-2-1.)</p> <div style="text-align: center;">  <p style="margin-left: 100px;">within 1.5~2 (recommended scale) Size scale</p> </div> <p style="text-align: center;">Fig. 3-2-1</p>	<p><u>Picture information amount</u></p> <p>The amount of information means the amount of the transmitted picture that can be displayed on the CPT screen. It is necessary to increase this amount of information as much as possible and also decrease the lack of raster as far as possible.</p>

## VERTICAL AMPLITUDE ADJUSTMENT

### ADJUSTMENT LOCATION VR601

Preparations for adjustment		Adjustment Procedure			Remarks
1	Start adjustment 5 minutes or more after the power switch is turned on.	1	Select V. CENT select chip E601 "u", "N" and "D" so that the center of the picture is closest to the geometrical center of the CPT		
2	Receive the PAL circle pattern signal.	2	Adjust VR601 as shown in Fig. 3-3-1.		
3	Set the brightness and contrast VRs to maximum.	3	Receive the NTSC circle pattern signal and check that the picture is the same as that when a PAL signal is received.		
4	Place the set facing north or south.				

Picture condition		Top shrunk, bottom expanded	Standard condition	Top expanded, bottom shrunk
Adjustment method	Picture top	Center of inner and outer circles	Center of inner circle	
	Picture bottom		Inner circle	Center of inner and outer circles

Fig. 3-3-1

### ADJUSTMENT POINT

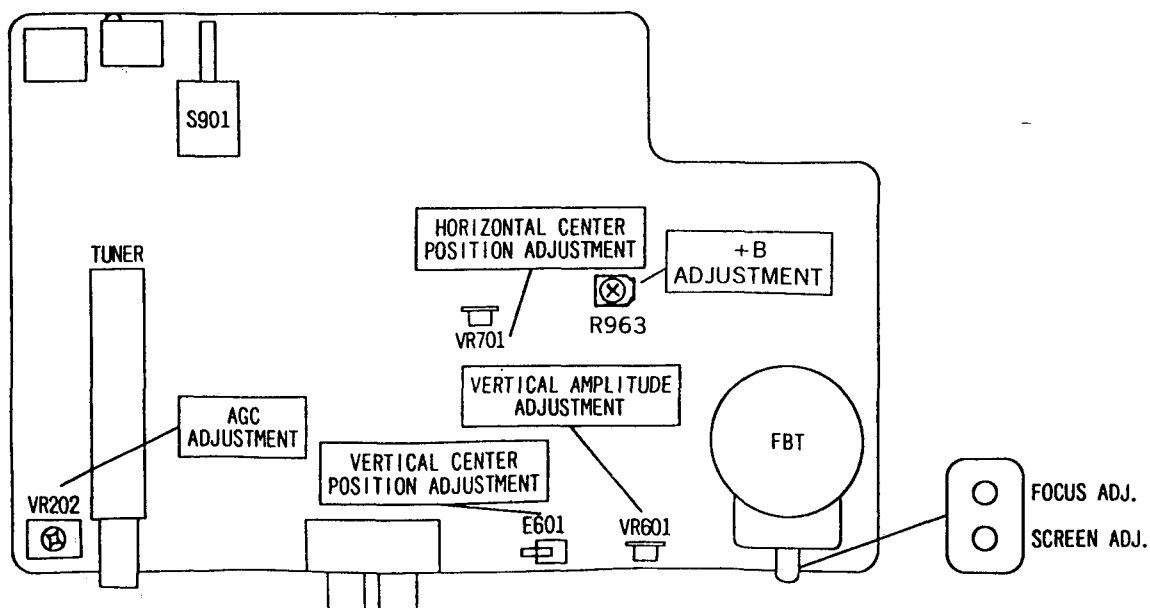

# C2178FS BASIC CIRCUIT DIAGRAM

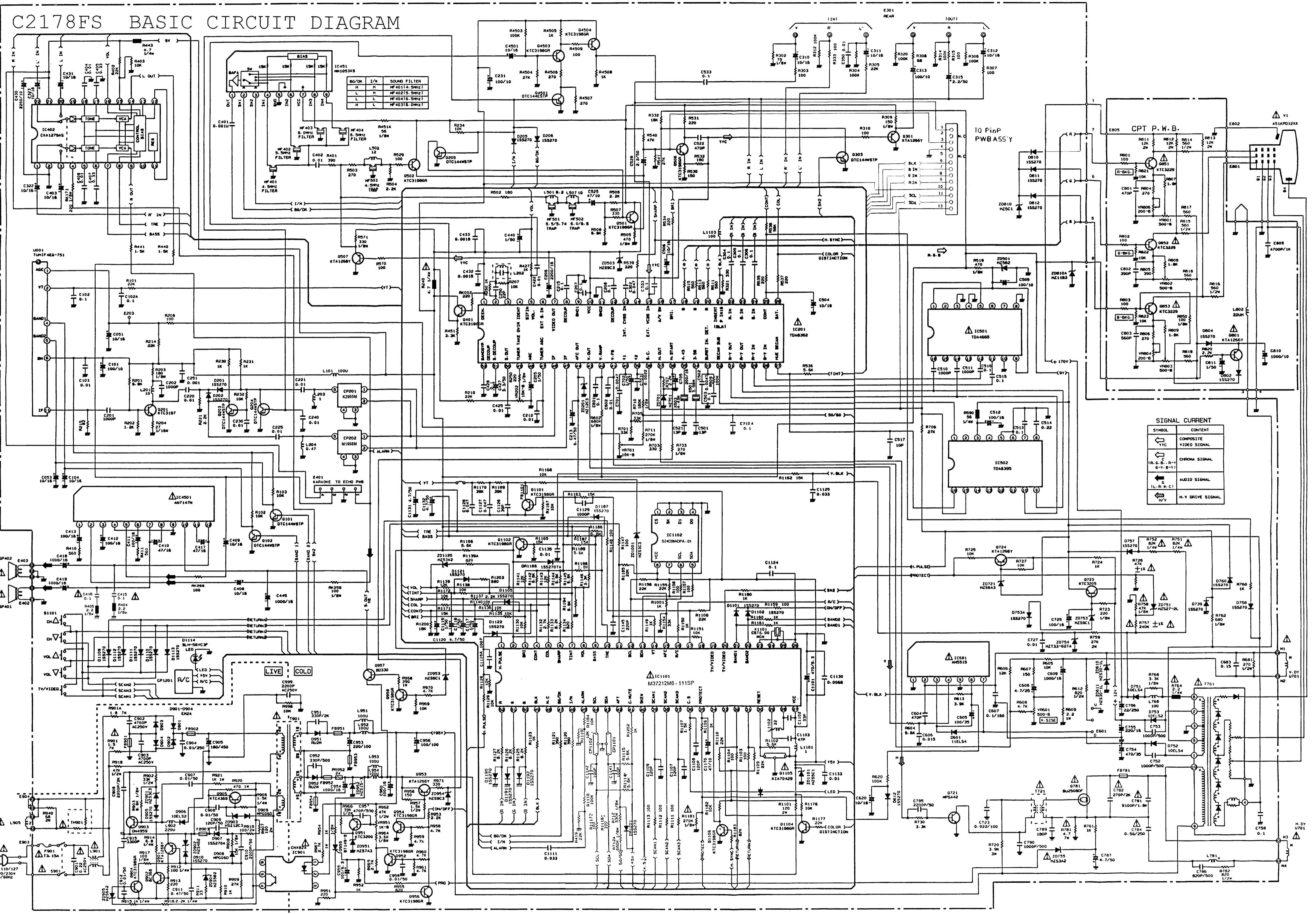

BO/DK	L/N	SOUND FILTER
H	H	MF4014.5MHz
L	L	MF40215.5MHz
H	L	MF40416.5MHz
L	H	MF40316.5MHz

SIGNAL CURRENT	
Symbol	CONTENT
YTC	COMPOSITE VIDEO SIGNAL
R-G-B, R-Y, G-Y, B-Y	CHROMA SIGNAL
L-R, W-C, I	AUDIO SIGNAL
H/V	H.V DRIVE SIGNAL

ABCDEFGHIJKLMNPQRSTUVWXYZ

abcdefghijklmnpqrstuvwxyz

αβγδελζηθ

# C2176PX BASIC CIRCUIT DIAGRAM

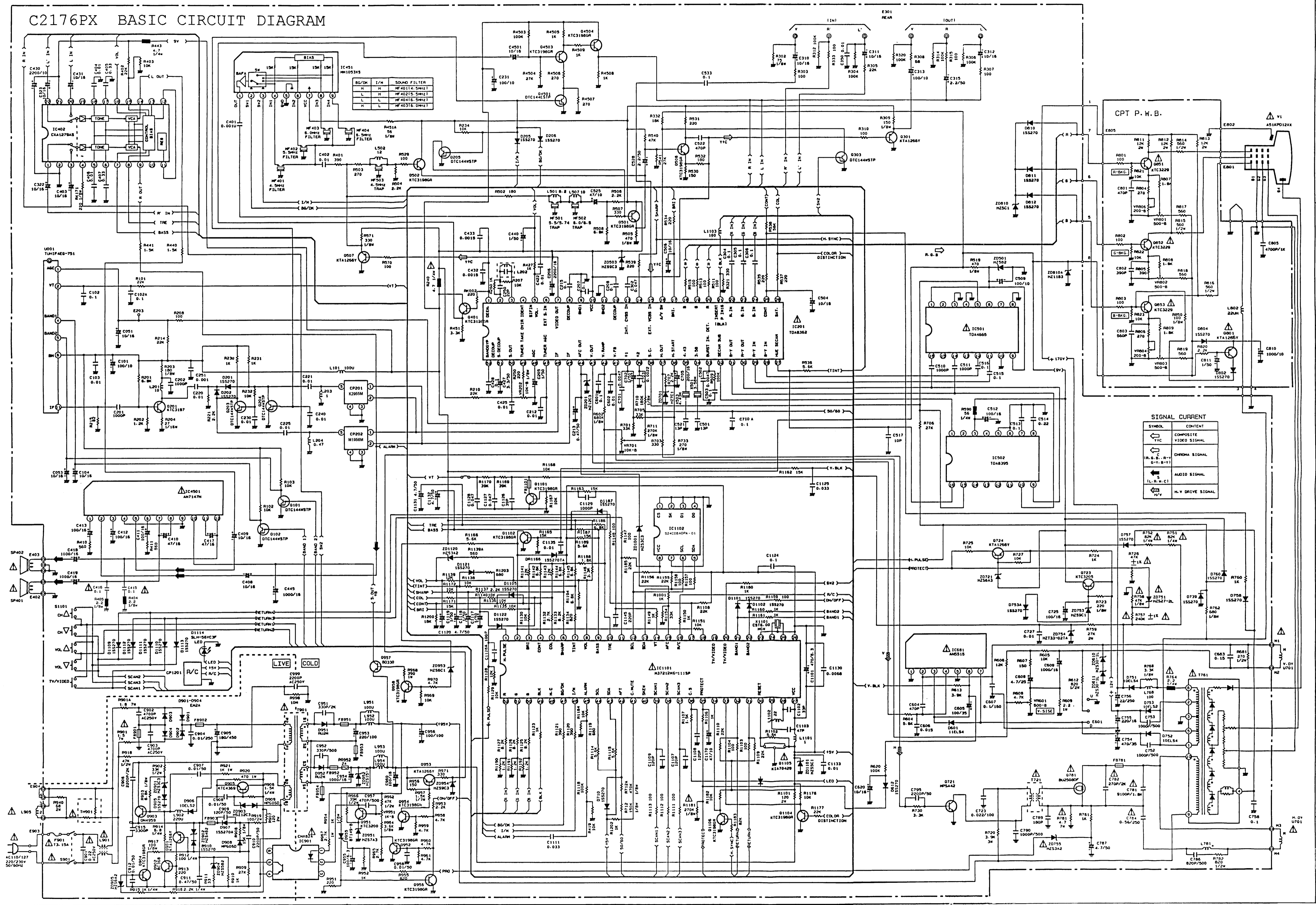

BG/DK	L/M	SOUND FILTER
H	H	WF4014.5MHz
L	L	WF4015.5MHz
L	L	WF4016.5MHz
H	L	WF4016.5MHz

SIGNAL CURRENT	
← YIC	COMPOSITE VIDEO SIGNAL
← R-G-B, R-Y, G-Y, B-Y	CHROMA SIGNAL
← L, B, W, C	AUDIO SIGNAL
← V/V	H.V. DRIVE SIGNAL

ABCDEFGHIJKLMNPQRSTUVWXYZ

abcdefghijklmnpqrstuvwxy

100

αβγδεζηθικλμνερϑ

# C2173MS BASIC CIRCUIT DIAGRAM

DESTINATION	
X	X
1	9
1	9
1	9
9	8

BL/DK	I/W	SOUND FILTER
H	H	HF4014.5MHz
L	L	HF4021.5MHz
L	L	HF4041.6MHz
H	L	HF4031.6MHz

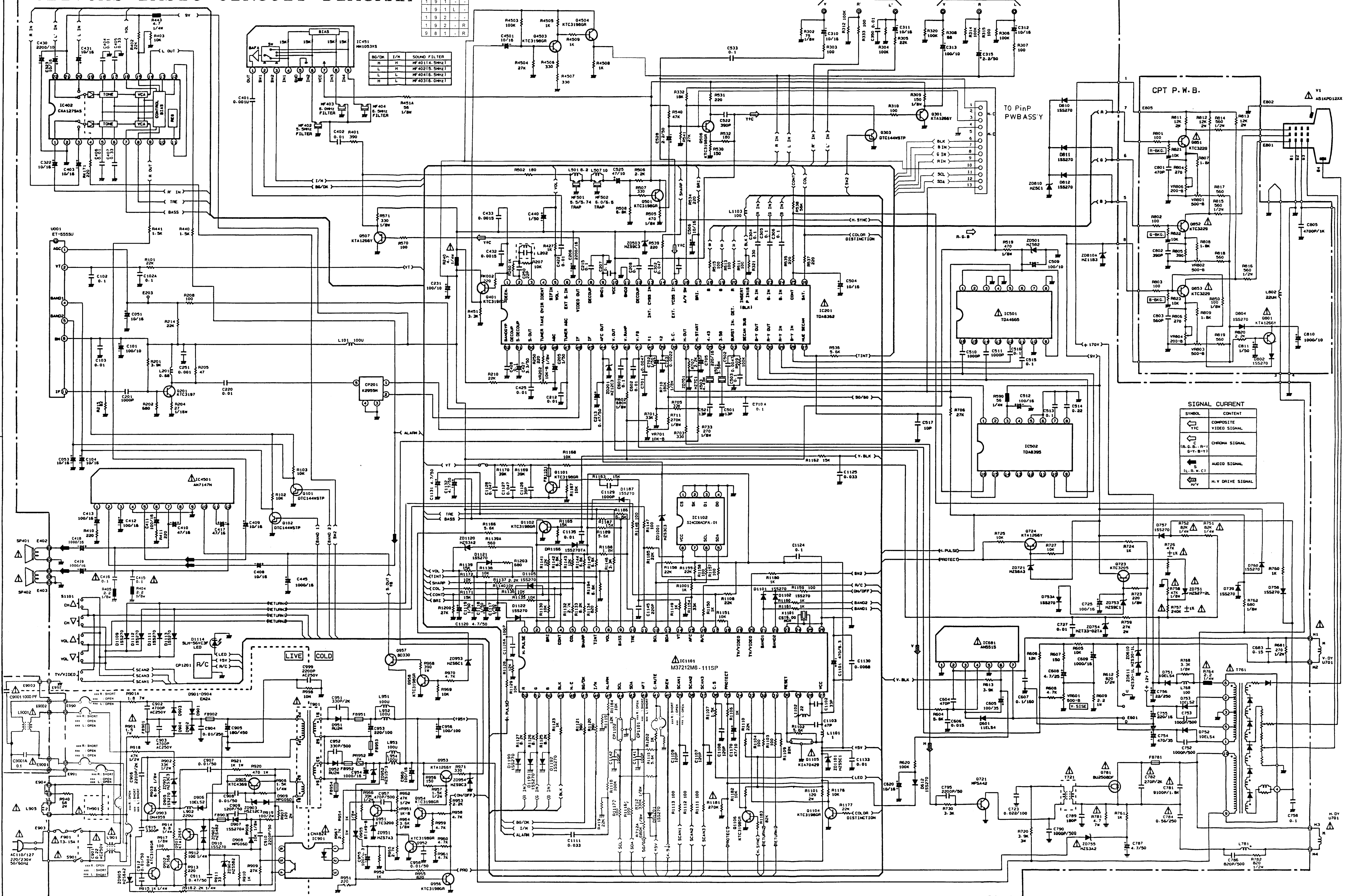

SIGNAL CURRENT	
Symbol	CONTENT
Y/C	COMPOSITE VIDEO SIGNAL
R, G, B, R-Y, G-Y, B-Y	CHROMA SIGNAL
L, R, W, C	AUDIO SIGNAL
V, V'	H.V. DRIVE SIGNAL

ABCDEFGHIJKLMNPQRSTUVWXYZ

abcdefghijklmnpqrstuvwxyz

100

αβγδελζηθικρσφ

# C2172MS BASIC CIRCUIT DIAGRAM

DESTINATION				
X	X	X	L	R
1	9	1	-	-
1	9	1	L	-
1	9	2	-	R
9	8	1	-	R

BO/DK	I/F	SOUND FILTER
H	H	MF4014.5MHz
L	H	MF40215.5MHz
L	L	MF40418.5MHz
H	L	MF40316.0MHz

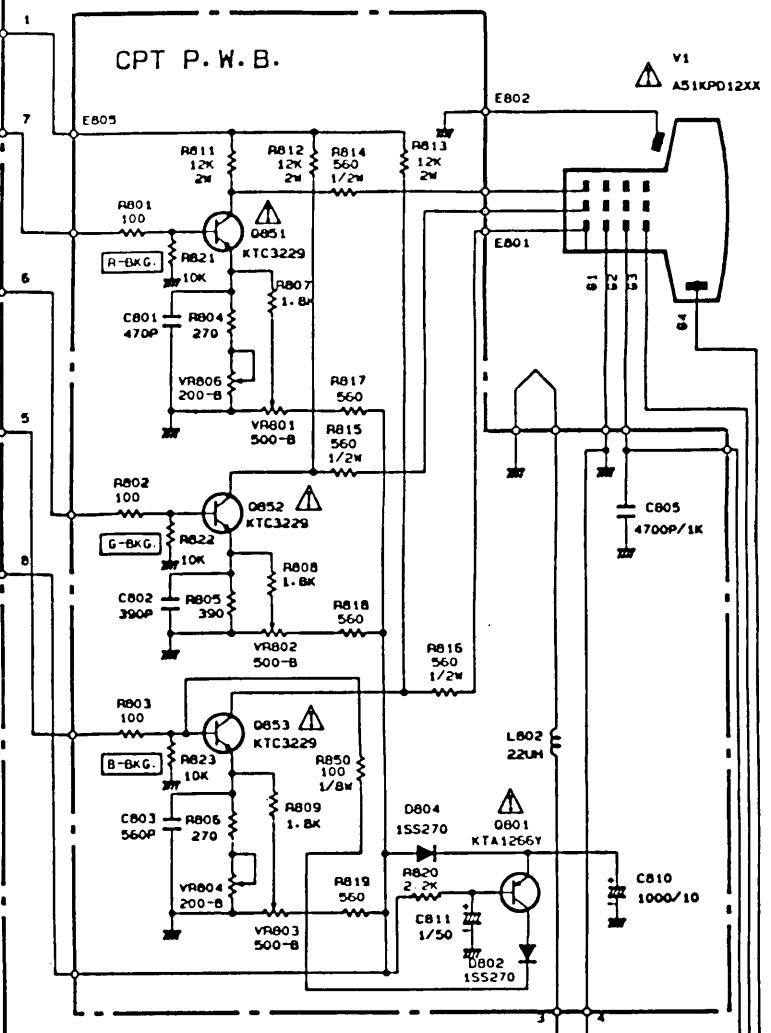
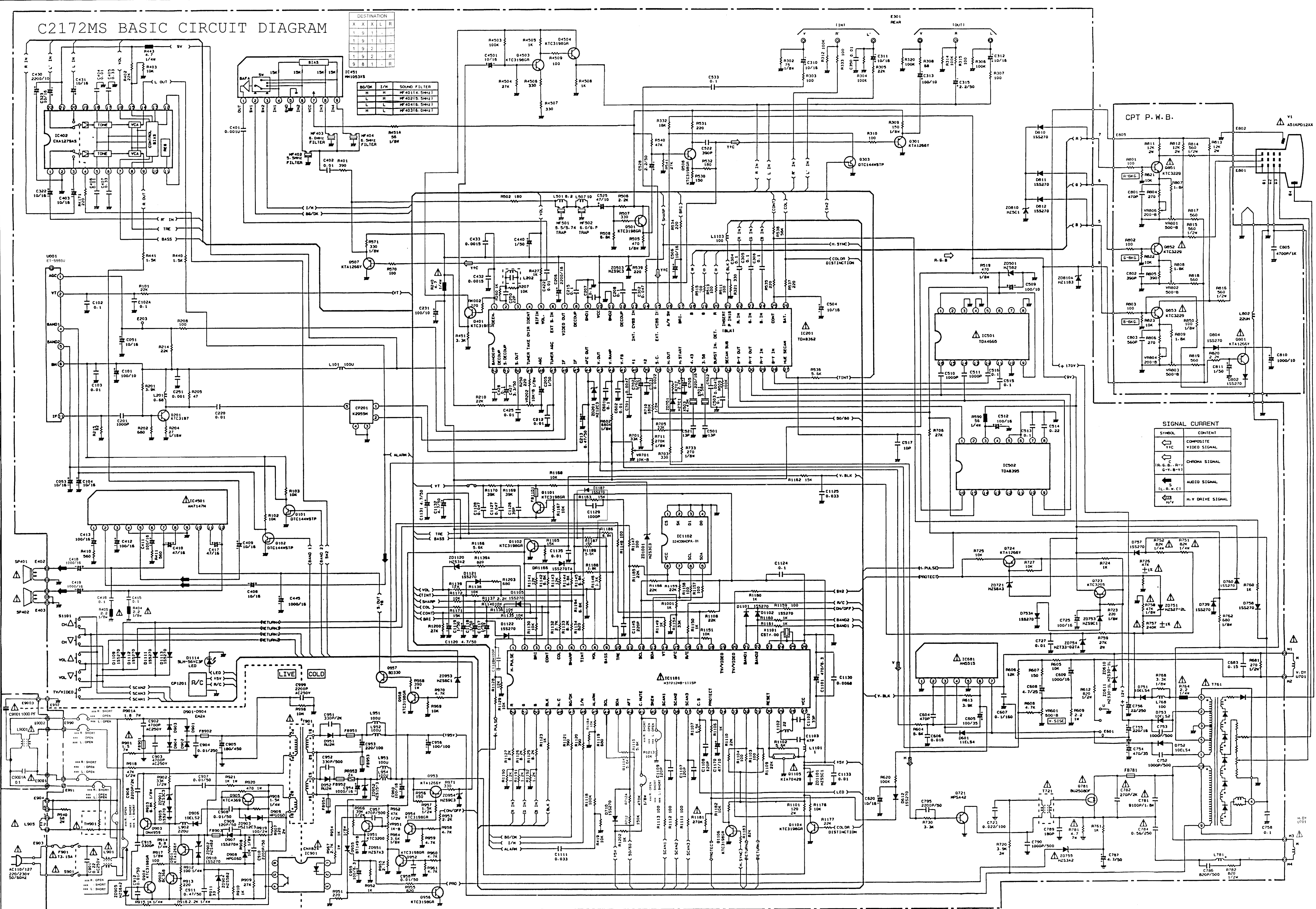

SYMBOL		CONTENT
←	YTC	COMPOSITE VIDEO SIGNAL
←	IR. G. B. R-Y	CHROMA SIGNAL
←	G-Y. B-Y	AUDIO SIGNAL
←	L. R. W. C1	H. V DRIVE SIGNAL

ABCDEFGHIJKLMNPQRSTUVWXYZ

abcdefghijklmnpqrstuvwxy

100

αβγδζηθλμκρ

# MAIN P.W.B.

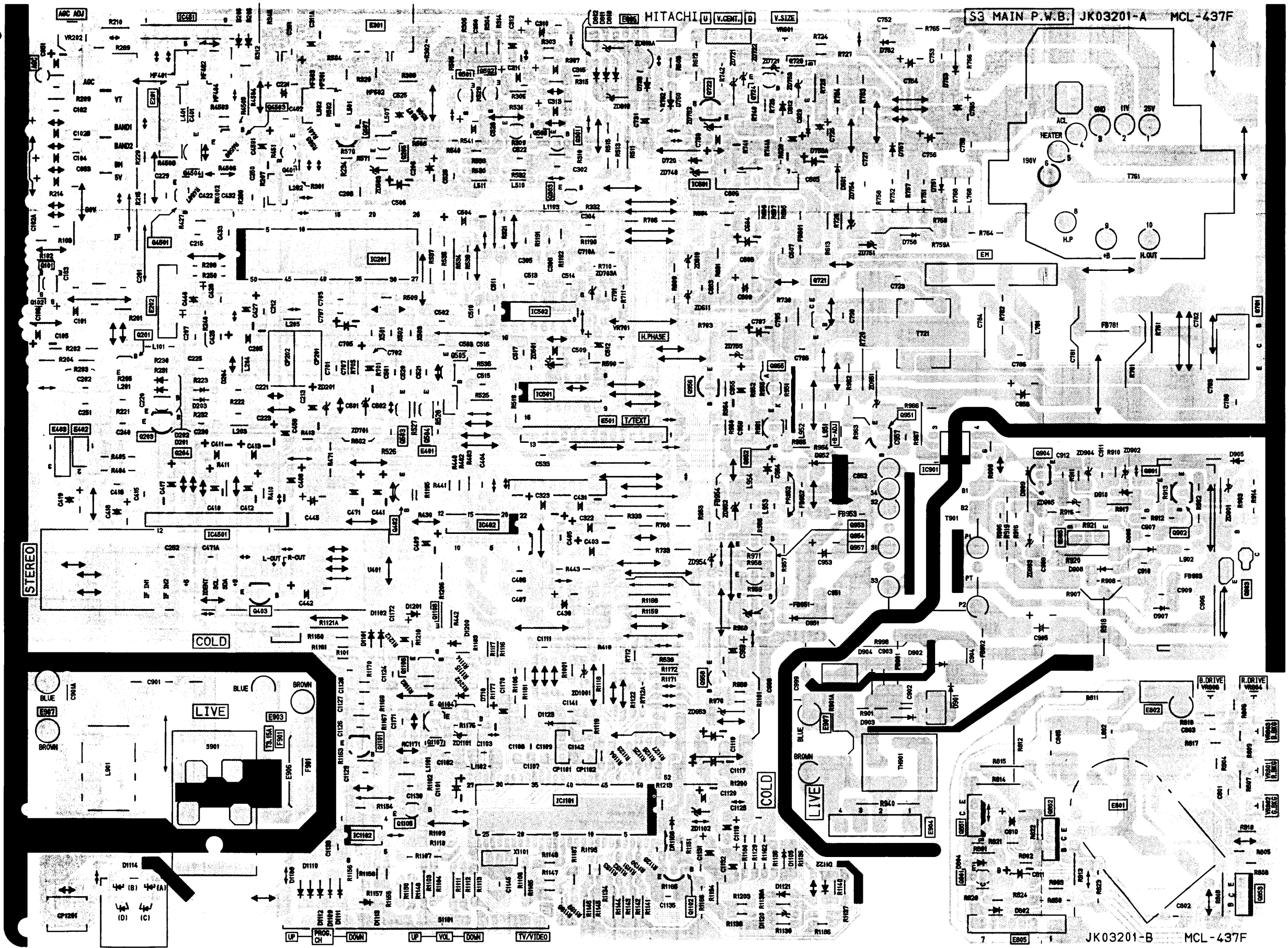

# B/W P in P CIRCUIT DIAGRAM

C2178FS / C2173MS ONLY

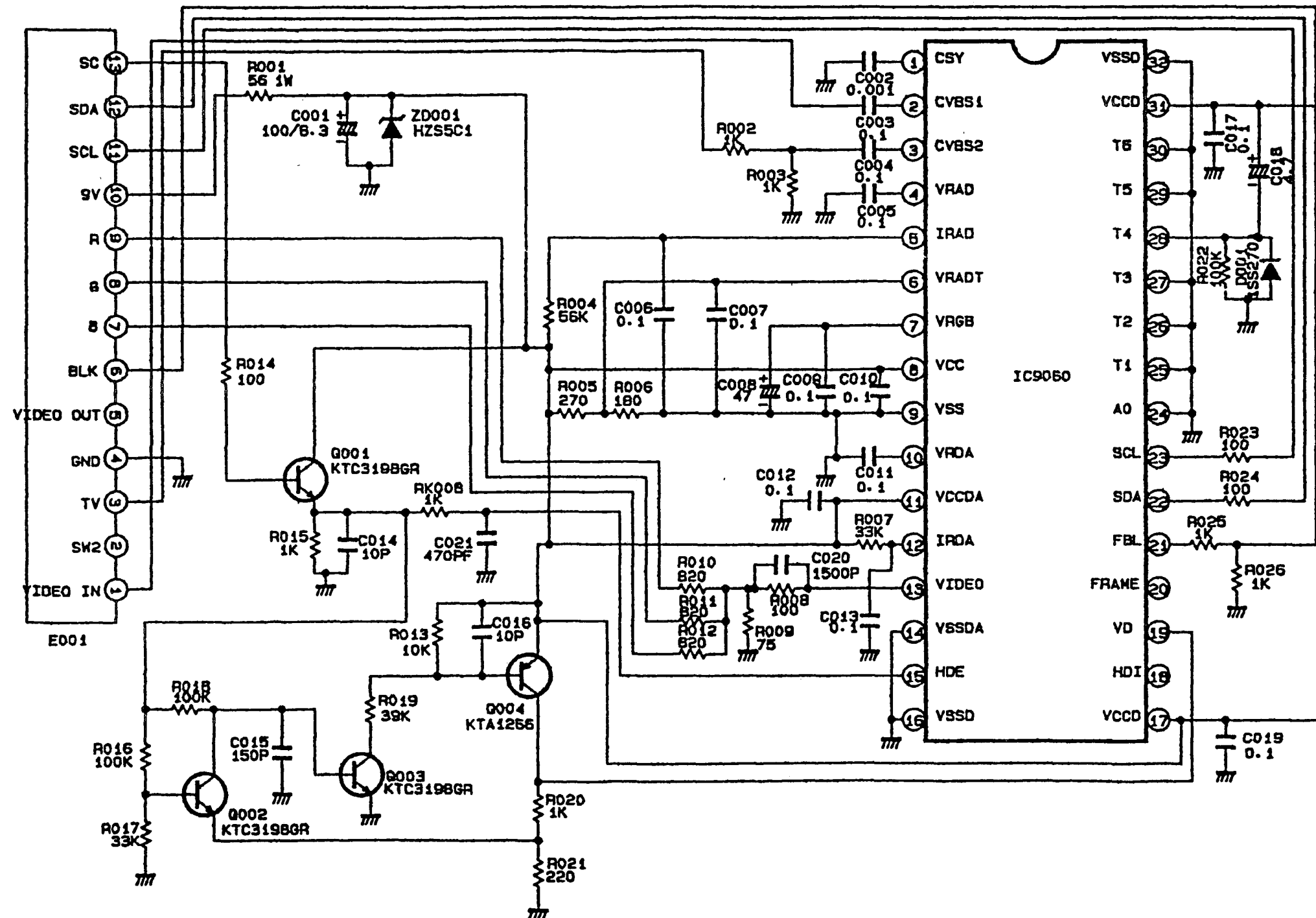



# MIC ECHO P. W. B.

C2178FS ONLY

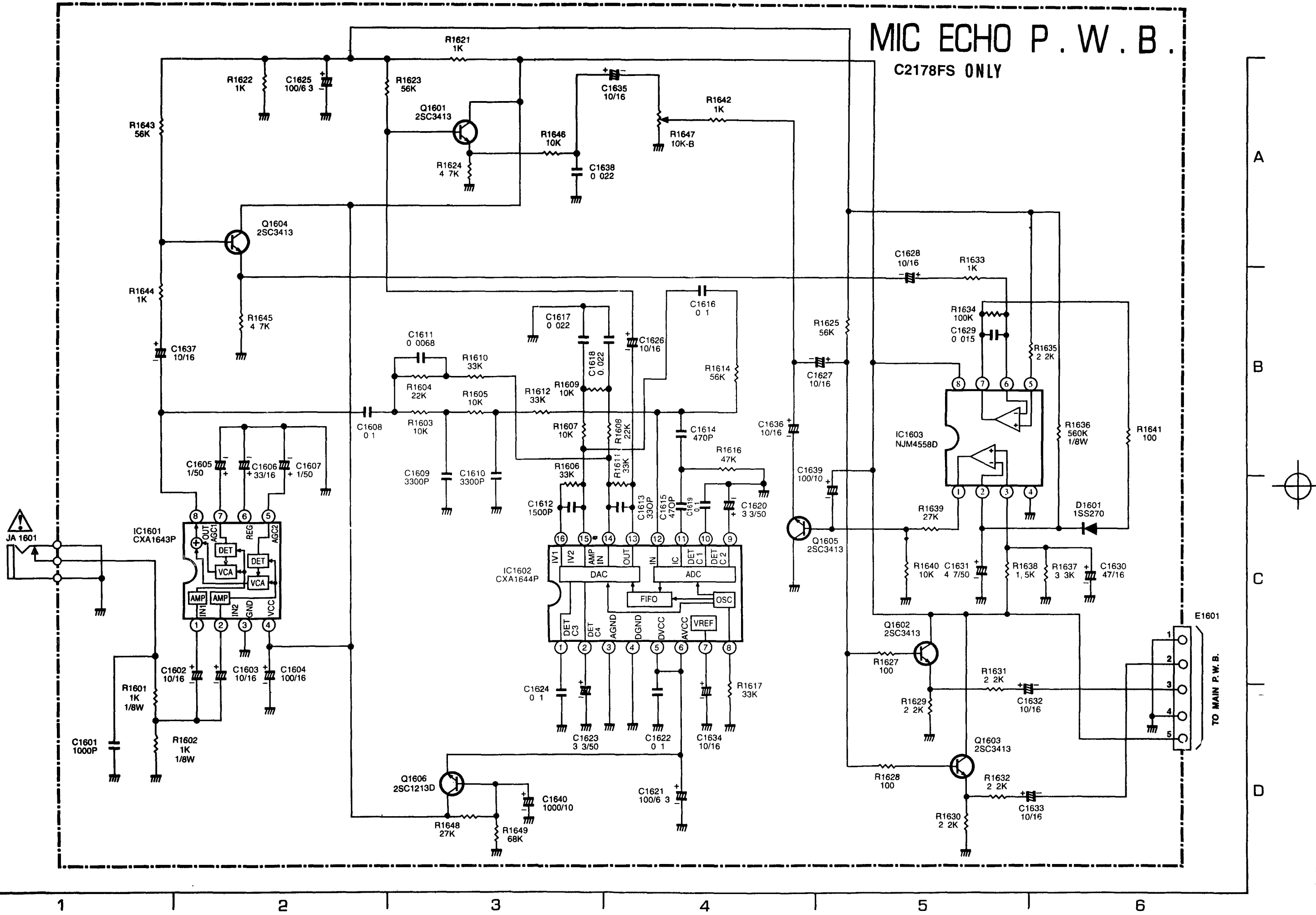

# WAVEFORMS

① IC201 ⑦ pin

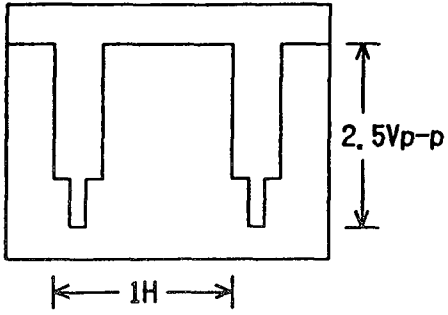

⑤ IC201 ⑳ pin

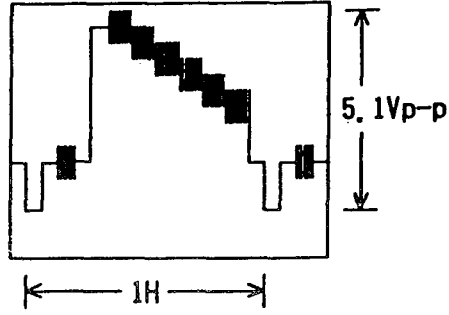

⑨ IC201 ㉔ pin

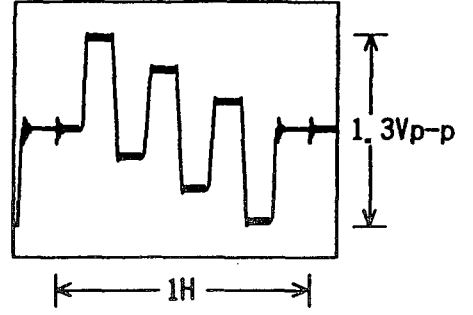

② V-DY

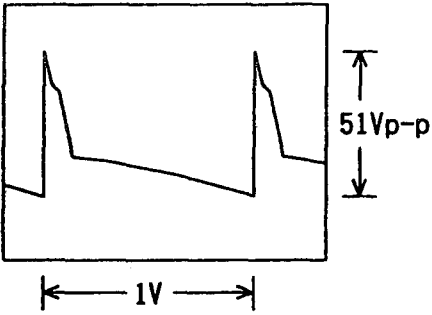

⑥ IC201 ㉓ pin SECAM

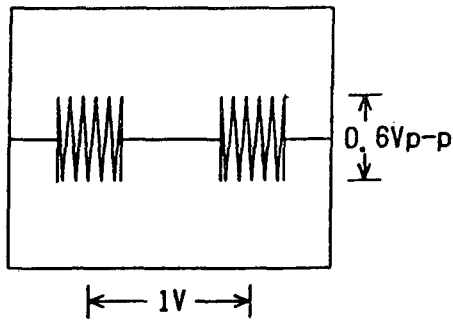

⑩ IC201 ㉔ pin

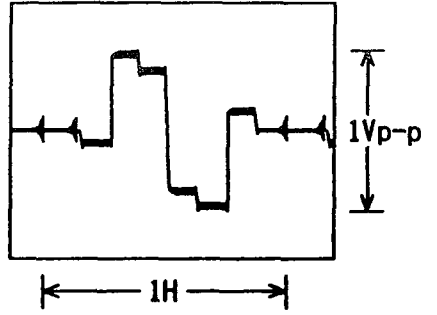

③ IC201 ㉓ pin

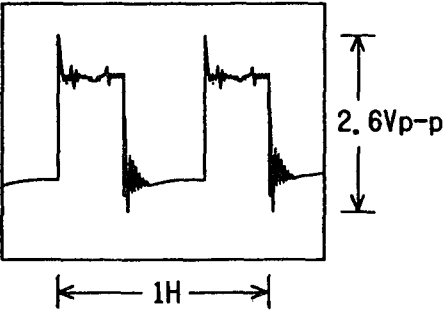

⑦ Q781 Collector

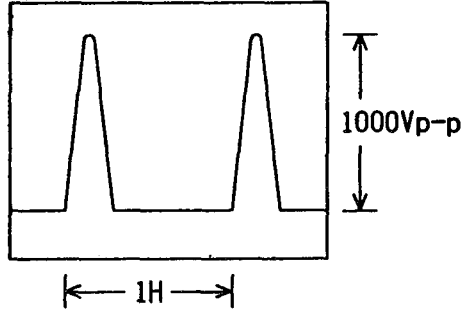

⑪ IC201 ㉔ pin NTSC/PAL

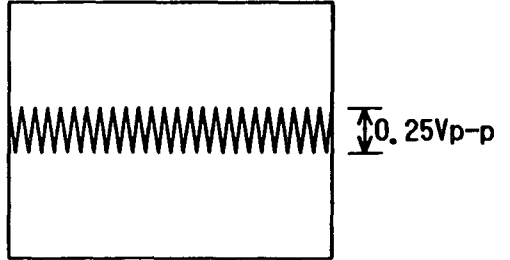

④ IC201 ㉓ pin

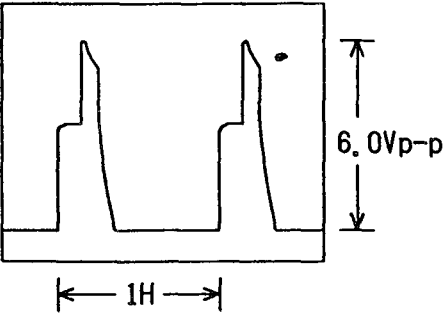

⑧ IC201 ㉔ pin

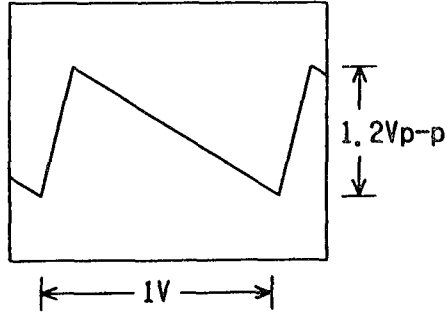

# WIRING DIAGRAM C2178FS

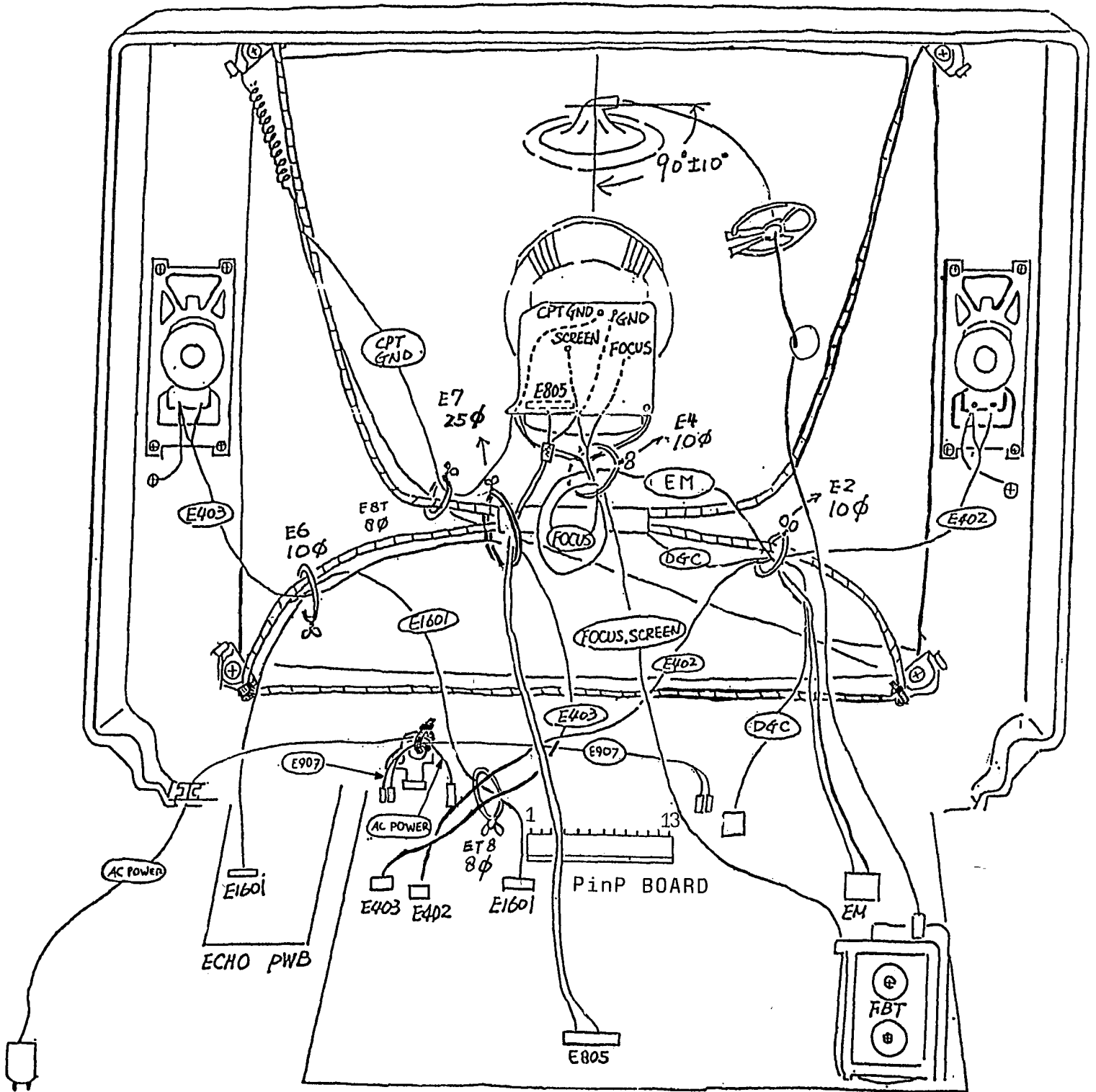

# WIRING DIAGRAM C2176PX

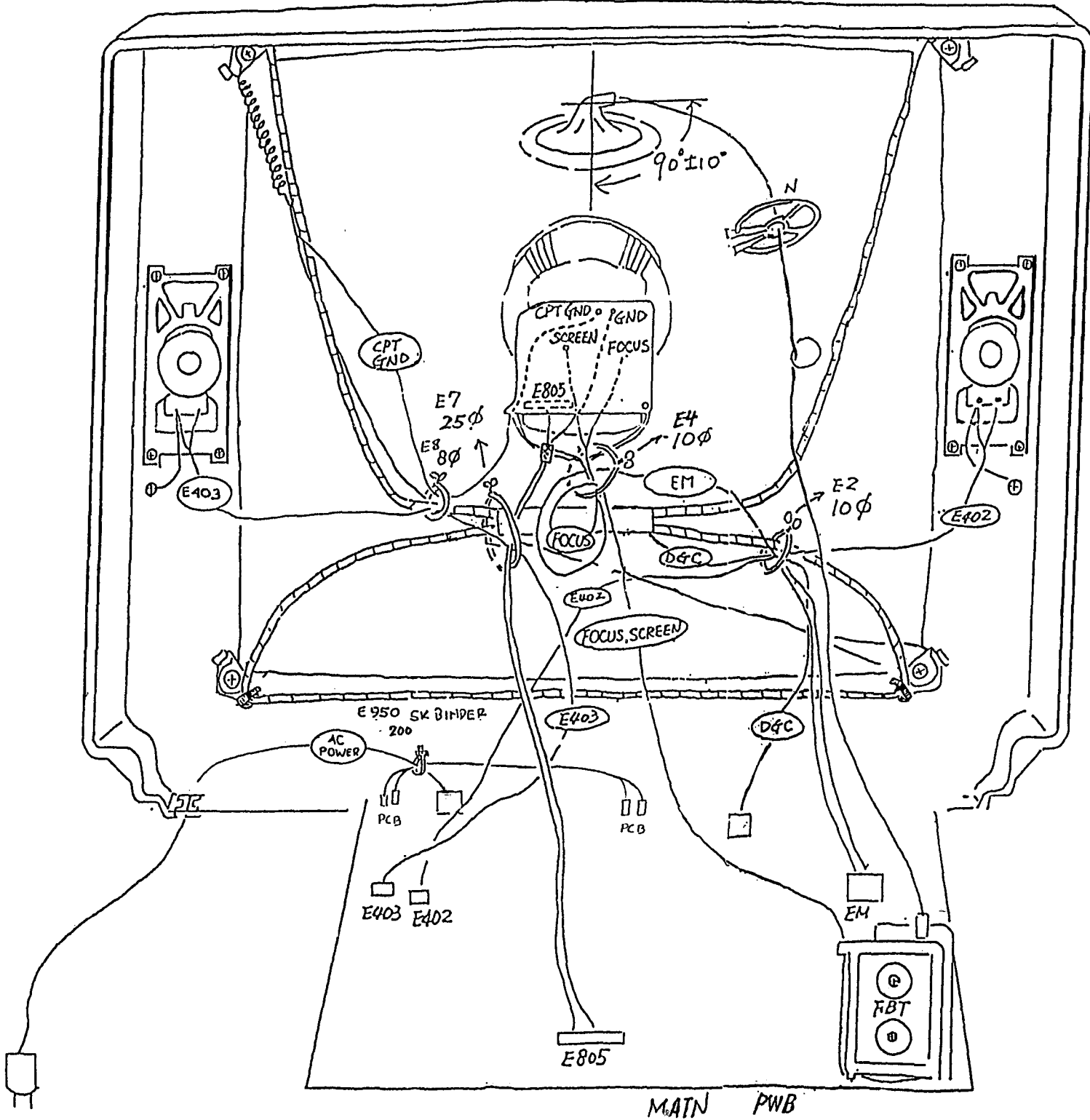

WIRING DIAGRAM C2173MS / 2172MS - 191 / L / 192 / 981

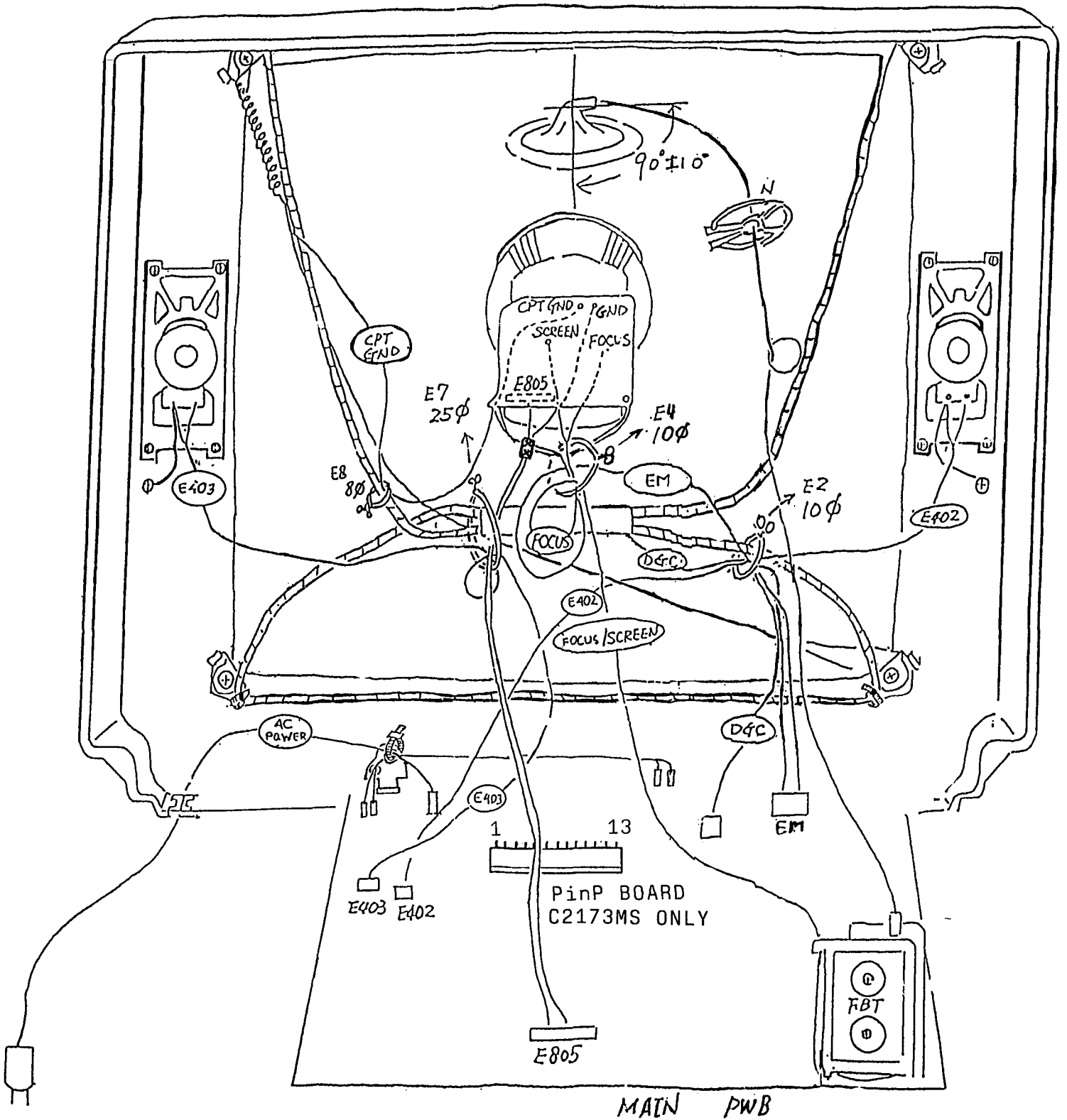

WIRING DIAGRAM C2173MS / 2172MS - 192R / 981R

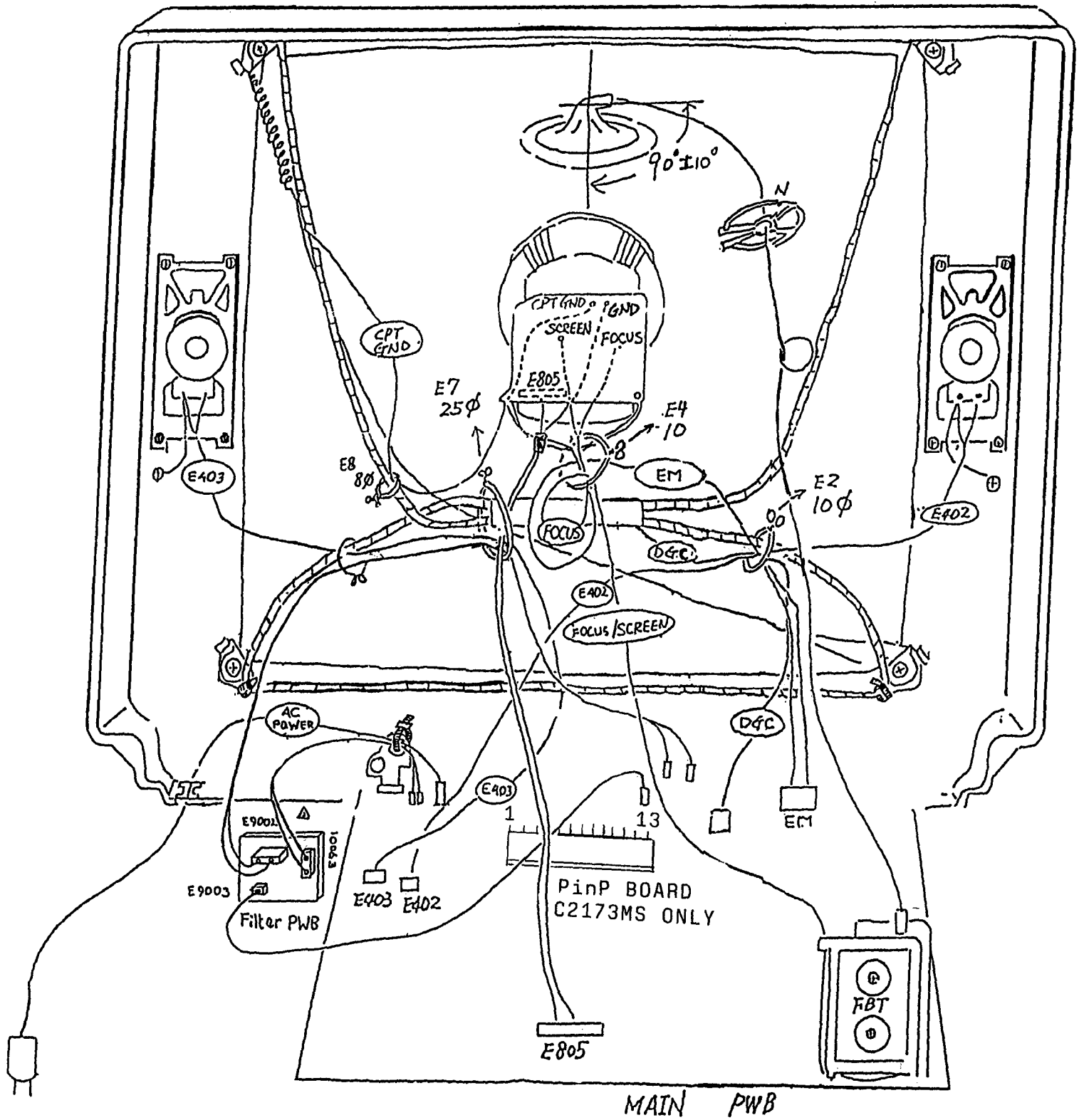





# REPLACEMENT PARTS LIST

**PRODUCT SAFETY NOTE** : Components marked with a **Δ** have special characteristics important to safety. Before replacing any of these components, read carefully the **PRODUCT SAFETY NOTICE** of this Service Manual. Don't degrade of the receiver through improper servicing

CP	CCT No	PARTS No	DESCRIPTION	CP	CCT No	PARTS No	DESCRIPTION
	#0102	4518753	2 3 NUT		C230	0880009R	MYLAR CAPAMZ 0 01UF-K 50V (C2178FS, C2176PX)
	#0104	4243445	G51 INSULATION WASHER		C231	0800048R	ELECT CAP SME 100UF 10V
	#0106	4518742	M2 3X12 SCREW WITH WASHER		C240	0880009R	MYLAR CAPAMZ 0 01UF-K 50V (C2178FS, C2176PX)
	#0112	3442421	HEAT SINK S2 TC30 IMMT		C250	0890118R	CER CAP CH 22PF-J 50V
	#0114	4519501	3 X 10 TNE SCREW		C251	0880003R	MYLAR CAP AMZ 0 001UF-K 50V
	#0115	4519507	3 X 6 TNE SCREW		C302	0880014R	MYLAR CAP AMZ 0 047UF-K 50V
	#0150	3708105	LED HOLDER (WHITE-WATSON)		C304	0880016R	MYLAR CAP AMZ 0 1UF-K 50V
	#0153	3701202	G7 PWB HOLD PIECE		C305	0880016R	MYLAR CAP AMZ 0 1UF-K 50V
	#0155	3746073	1EC CORD HANGER CPT 213X		C306	0880016R	MYLAR CAPAMZ 0 1UF-50V
	#0902	4520883	3*12 SCREW WITH WASHER		C310	0800015R	ELECT CAP SME 10UF 16V
	#0910	MA00801	HEAT SINK		C311	0800015R	ELECT CAP SME 10UF 16V
	#905	4520881	M3X8 SCREW WITH WASHER		C312	0800015R	ELECT CAP SME 10UF 16V
	B001	JK03201E	S3 MAIN PWB		C313	0800048R	ELECT CAP SME 100UF 10V
	C051	0800015R	ELECT CAP SME 10UF 16V		C315	0800005R	ELECT CAP SME 10UF 16V
	C053	0800015R	ELECT CAP SME 10UF 16V		C322	0800015R	ELECT CAP SME 10UF 16V
	C101	0800048R	ELECT CAP SME 100UF 10V		C323	0800015R	ELECT CAP SME 10UF 16V
	C102	0880016R	MYLAR CAP AMZ 0 1UF-K 50V		C350	0880009R	MYLAR CAP AMZ 0 01UF-K 50V
	C102A	0880016R	MYLAR CAP AMZ 0 1UF-K 50V		C401	0880003R	MYLAR CAP AMZ 0 001UF-K 50V
	C103	0880009R	MYLAR CAP AMZ 0 01UF-K 50V		C402	0880009R	MYLAR CAP AMZ 0 01UF-K 50V
	C104	0800015R	ELECT CAP SME 10UF 16V		C403	0800015R	ELECT CAP SME 10UF 16V
	C1101	0800072R	ELECT CAP SME 470UF 6 3V		C404	0880009R	MYLAR CAP AMZ 0 01UF-K 50V
	C1107	0890075R	CER CAP SL 120PF-J 50V		C405	0270741R	CAP POLY 0 33UF 50V
	C1108	0890075R	CER CAP SL 120PF-J 50V		C406	0880009R	MYLAR CAPAMZ 0 01UF-K 50V
	C1109	0890075R	CER CAP SL 120PF-J 50V		C407	0270741R	CAP POLY 0 33UF 50V
	C1111	0880013R	MYLAR CAP AMZ 0 033UF-K 50V		C408	0800015R	ELECT CAP SME 10UF 16V
	C1117	0800003R	ELECT CAP SME 1UF 50V		C409	0800015R	ELECT CAP SME 10UF 16V
	C1118	0800003R	ELECT CAP SME 1UF 50V		C410	0800041R	ELECT CAP SME 47UF 16V
	C1119	0800003R	ELECT CAP SME 1UF 50V		C411	0800049R	ELECT CAP SME 100UF 16V
	C1120	0800012R	ELECT CAP SME 4 7UF 50V		C412	0800049R	ELECT CAP SME 100UF 16V
	C1124	0880016R	MYLAR CAP AMZ 0 1UF-K 50V		C413	0800049R	ELECT CAP SME 100UF 16V
	C1125	0880013R	MYLAR CAP AMZ 0 033UF-K 50V		C415	0880016R	MYLAR CAPAMZ 0 1UF-K 50V
	C1126	0890122R	CER CAP CH 39PF-J 50V		C416	0880016R	MYLAR CAPAMZ 0 1UF-K 50V
	C1127	0880014R	MYLAR CAP AMZ 0 047UF-K 50V		C417	0800041R	ELECT CAP SME 47UF 16V
	C1128	0880014R	MYLAR CAP AMZ 0 47UF-K 50V		C418	0800082F	ELECT CAP SME 100UF 16V
	C1128A	0890074R	CER CAP 100PF-J 50V		C419	0800082F	ELECT CAP SME 1000UF 16V
	C1129	0880003R	MYLAR CAP AMZ 0 001UF-K 50V		C422	0880009R	MYLAR CAPAMZ 0 01UF-K 50V
	C1130	0880008R	MYLAR CAP AMZ 0 0068UF-K 50V		C425	0880009R	MYLAR CAPAMZ 0 01UF-K 50V
	C1131	0800012R	ELECT CAP SME 4 7UF 50V		C427	0800007R	ELECT CAP SME 3 3UF 50V
	C1132	0800012R	ELECT CAP SME 4 7UF 50V		C428	0880016R	MYLAR CAPAMZ 0 1UF-K 50V
	C1133	0880009R	MYLAR CAP AMZ 0 01UF-K 50V		C430	0800366F	ELECT CAP SME 2200UF 10V
	C1135	0880009R	MYLAR CAP AMZ 0 01UF-K 50V		C431	0800015R	ELECT CAP SME 10UF 16V
	C1141	0890074R	CER CAP SL 100PF-J 50V (C2178FS, C2173MS)		C432	0880004R	MYLAR CAPAMZ 0 0015UF-K 50V
	C1142	0890074R	CER CAP SL 100PF-J 50V (C2178FS, C2173MS)		C433	0880004R	MYLAR CAPAMZ 0 0015UF-K 50V
	C1145	0890078R	CER CAP B 220PF-K 50V		C440	0284623R	ELECT CAP SME 1UF 50V (BP)
	C1170	0800039R	ELECT CAP SME 47UF 10V		C445	0800082F	ELECT CAP SME 1000UF 16V
	C201	0890087R	CER CAP B 1000PF-K 50V		C4501	0800015R	ELECT CAP SME 10UF 16V
	C202	0890087R	CER CAP B 1000PF-K 50V (C2178FS, C2176PX)		C501	0890116R	CER CAP CH 15PF-J 50V
	C205	0800003R	ELECT CAP SME 1UF 50V		C502	0880007R	MYLAR CAPAMZ 0 0047UF-K 50V
	C206	0800087F	ELECT CAP SME 2200UF 16V		C503	0880016R	MYLAR CAPAMZ 0 1UF-K 50V
	C207	0880016R	MYLAR CAP AMZ 0 1UF-K 50V		C504	0800015R	ELECT CAP SME 10UF 16V
	C208	0880016R	MYLAR CAP AMZ 0 1UF-K 50V		C506	0800015R	ELECT CAP SME 10UF 16V
	C212	0880009R	MYLAR CAP AMZ 0 01UF-K 50V		C509	0800048R	ELECT CAP SME 100UF 10V
	C213	0800001R	ELECT CAP SME 0 47UF 50V		C510	0890087R	CER CAP B 1000PF-K 50V
	C215	0880016R	MYLAR CAP AMZ 0 1UF-K 50V		C511	0890087R	CER CAP B 1000PF-K 50V
	C220	0880009R	MYLAR CAP AMZ 0 01UF-K 50V		C512	0800049R	ELECT CAP SME 100UF 16 V
	C221	0880009R	MYLAR CAPAMZ 0 01UF-K 50V (C2178FS, C2176PX)		C513	0880016R	MYLAR CAPAMZ 0 1UF-K 50V
	C225	0880009R	MYLAR CAPAMZ 0.01UF-K 50V (C2178FS, C2176PX)		C514	0880018R	MYLAR CAPAMZ 0 22UF-K 50V
					C515	0880016R	MYLAR CAPAMZ 0 1UF-K 50V
					C516	0880016R	MYLAR CAPAMZ 0 1UF-K 50V
					C517	0890061R	CER CAP SL 10PF-D 50V

# REPLACEMENT PARTS LIST

**PRODUCT SAFETY NOTE** : Components marked with a  have special characteristics important to safety. Before replacing any of these components, read carefully the **PRODUCT SAFETY NOTICE** of this Service Manual. Don't degrade of the receiver through improper servicing

CP	CCT No	PARTS No	DESCRIPTION	CP	CCT No	PARTS No	DESCRIPTION
	C521	0248663R	CER CAP SL 13PF-J 50V		C955	0800047R	ELECT CAP SME 100UF 6 3V
	C522	0890083R	CER CAP B 470PF-K 50V		C956	0800055N	ELECT CAP SME 100UF 100V
	C522	0890082R	CER CAP B 390PF-K 50V (C2178FS, C2176PX)		C957	0243509R	CER CAP B 470PF-K 500V
	C525	0284666R	ELECT CAP SME 47UF 10V (BP)		C958	0880009R	MYLAR CAP AMZ 0 01UF-K 50V
	C528	0800005R	ELECT CAP SME 2 2UF 50V		C960	0800049R	ELECT CAP SME 100UF 16V
	C533	0880016R	MYLAR CAP AMZ 0 1UF-K 50V		C999	AJ00184F	POLY CAP 2200PF 250V
	C601	0880016R	MYLAR CAP AMZ 0 1UF-K 50V		CP1101	2791754R	LC FILTER DSS306-55B101 (C2178FS, C2173MS)
	C602	0880044R	POLY CAP B (F) 0 01UF-K 50V		CP1102	2791754R	LC FILTER DSS306-55B101 (C2178FS, C2173MS)
	C604	0890083R	CER CAP B 470PF-K 50V		CP1201	2574762A	R/C RECIVER (SONY)
	C605	0800052R	ELECT CAP SME 100UF 35V		CP201	BG01011	SAW FILTER K2955M
	C606	0880011R	MYLAR CAP AMZ 0 015UF-K 50V		CP202	BG01011A	SAW FILTER M1956M (C2178FS, C2176PX)
	C607	0279693R	POLY CAP 0 1UF-K 100V		D1101	2338321M	DIODE 1SS270
	C608	0800009R	ELECT CAP SME 4 7UF 25V		D1102	2338321M	DIODE 1SS270
	C609	0800082F	ELECT CAP SME 1000UF 16V		D1105	2338321M	DIODE 1SS270
	C620	0800015R	ELECT CAP SME 10UF 16V		D1109	2338321M	DIODE 1SS270
	C683	0880017R	MYLAR CAP AMZ 0 15UF-K 50V		D1110	2338321M	DIODE 1SS270 (C2178FS, C2176PX)
	C701	0880007R	MYLAR CAP AMZ 0 0047UF-K 50V		D1111	2338321M	DIODE 1SS270
	C702	0800003R	ELECT CAP SME 1UF 50V		D1112	2338321M	DIODE 1SS270
	C703	0880005R	MYLAR CAP AMZ 0 0022UF-K 50V		D1113	2338321M	DIODE 1SS270
	C705	0800058R	ELECT CAP SME 220UF 16V		D1114	CH00231K	LED SLH-56VC3F (RED)
	C710A	0880016R	MYLAR CAP AMZ 0 1UF-K 50V		D1121	2338321M	DIODE 1SS270
	C723	0279851F	POLY CAP 0 022UF-K 100V		D1122	2338321M	DIODE 1SS270
	C725	0800049R	ELECT CAP SME 100UF 16V		D1187	2338321M	DIODE 1SS270
	C727	0880009R	MYLAR CAP AMZ 0 01UF-K 50V		D1190	2338321M	DIODE 1SS270 (C2178FS, C2173MS)
	C752	0244501R	CER CAP B 1000PF-K 500V		D1191	2338321M	DIODE 1SS270 (C2178FS, C2173MS)
	C753	0244501R	CER CAP B 1000PF-K 500V		D1192	2388321M	DIODE 1SS270 (C2178FS, C2173MS)
	C754	0800076F	ELECT CAP SME 470UF 35V		D201	2338321M	DIODE 1SS270 (C2178FS, C2176PX)
	C755	0800058R	ELECT CAP SME 220UF 16V		D202	2338321M	DIODE 1SS270 (C2178FS, C2176PX)
	C756	0253973F	ELECT CAP SME 22UF 250V		D205	2338321M	DIODE 1SS270 (C2178FS, C2176PX)
	C758	0880016R	MYLAR CAP AMZ 0 1UF-K 50V		D206	2338321M	DIODE 1SS270 (C2178FS, C2176PX)
	C781	0262426F	POLY CAP 9100PF-J 1 8KV		D601	CH00681M	DIODE 11ES2 200V
	C782	0244717	CER CAP 270PF 2KV		D612	2338321M	DIODE 1SS270
	C784	0262801F	POLY CAP 0 56UF-J 250V		D710	2338321M	DIODE 1SS270
	C786	0243512R	CER CAP B 820PF-K 500V		D739	2338321M	DIODE 1SS270
	C787	0800012R	ELECT CAP SME 4 7UF 50V		D751	CH00712M	DIODE 10ELS 400V
	C789	0890077R	CER CAP B 180PF-K 50V		D752	CH00712M	DIODE 10ELS 400V
	C790	0244501R	CER CAP B 1000PF-K 500V		D753	CH00711M	DIODE 10ELS2
	C795	0880005R	MYLAR CAP AMZ 0 0022UF-K 50V		D753A	2338321M	DIODE 1SS270
	C801	0890083R	CER CAP B 470PF-K 50V		D757	2338321M	DIODE 1SS270
	C802	0890082R	CER CAP B 390PF-K 50V		D758	2338321M	DIODE 1SS270
	C803	0890084R	CER CAP B 560PF-K 50V		D760	2338321M	DIODE 1SS270
	C805	0245612F	CER CAP B 4700PF-K 1KV		D802	2338321M	DIODE 1SS270
	C810	0800359R	ELECT CAP SMG 1000UF 10V		D804	2338321M	DIODE 1SS270
	C811	0800003R	ELECT CAP SME 1UF 50V		D810	2338321M	DIODE 1SS270
	C901	AN00144S	POLY CAP 0 1UF-M 250V		D811	2338321M	DIODE 1SS270
	C902	0248593F	CER CAP F 4700PF-Z 250V		D812	2338321M	DIODE 1SS270
	C903	0248593F	CER CAP F 4700PF-Z 250 V		D901	2342711M	DIODE EM2A
	C904	0248594F	CER CAP F 0 01UF-Z 250V		D902	2342711M	DIODE EM2A
	C905	AL00097	ELECT CAP 180UF 450V		D903	2342711M	DIODE EM2A
	C906	0244215	CER CAP R 2200PF-K 2KV		D904	2342711M	DIODE EM2A
	C907	0880009R	MYLAR CAP AMZ 0 01UF-K 50V		D905	2338321M	DIODE 1SS270
	C908	0880009R	MYLAR CAP AMZ 0 01UF-K 50V		D906	CH00711M	DIODE 10ELS2
	C909	0890075R	CER CAP SL 120PF-J 50V		D907	2337341M	DIODE 1SS270A (TP)
	C910	0880005R	MYLAR CAP AMZ 0 0022UF-K 50V		D908	2343961M	DIODE MPG06D
	C911	0880203R	POLY CAP AMZ 0 47UF 50V		D909	2343961M	DIODE MPG06D
	C912	0880009R	MYLAR CAP AMZ 0 01UF-K 50V		D910	2338321M	DIODE 1SS270
	C915	0880006R	MYLAR CAP AMZ 0.0033UF-K 50V		D951	2333001M	DIODE RU2M
	C951	0244718	CER CAP B 330PF-K 2KV				
	C952	0243507	CER CAP B 330PF-K 500V				
	C953	0258129F	ELECT CAP KME 220UF 100V				
	C954	0800082F	ELECT CAP SME 1000UF 16V				





# REPLACEMENT PARTS LIST

**PRODUCT SAFETY NOTE :** Components marked with a have special characteristics important to safety. Before replacing any of these components, read carefully the **PRODUCT SAFETY NOTICE** of this Service Manual. Don't degrade of the receiver through improper servicing

CP	CCT No	PARTS No	DESCRIPTION	CP	CCT No	PARTS No	DESCRIPTION
	D952	2333001M	DIODE RU2M		L201	2123409M	AXIAL COIL LAL02 0 68UH-K (C2173MS C2172MS)
	DR1166	2338321M	DIODE ISS270		L202	2146114	HIGH FREQ COIL 38 9MHZ
	E203	2774721R	FERRITE BEAD CORE WITH LEAD		L203	2123411M	AXIAL COIL LAL02 1 0UH-K (C2178FS, C2176PX)
	E301	2695261	6P JACK PIN		L204	2123407M	AXIAL COIL LAL02 0 47UH-K (C2178FS, C2176PX)
	E401	2902263	PLUG PIN SUB MINI 4P (C2178FS)		L205	2123413M	AXIAL COIL LAL02 1 5UH-K (C2173MS C2172MS)
	E402	2902261	PIN POST(B28-EH)		L501	2123102M	AXIAL COIL LAL02 8 2UH-K
	E403	2902262	PIN POST(B3B-EH)		L502	2123104M	AXIAL COIL LAL02 12UH-K (C2178FS C2176PX)
	E501	2902272	12PH CONNECTOR (C2178FS, C2173MS)		L507	2123103M	AXIAL COIL LAL02 10UH-K
	E601	2611361	LEVER SWITCH TLE-100		L768	2122253M	AXIAL COIL LAL04 100UH0K
	E801	2698352C	CRT SOCKET 21*		L781	2164541B	HORIZONTAL LINEARITY COIL
	E802	2903542	2P PLUG PIN (TV-50P-02-V1)		L802	BH00205R	HIGH FREQ INDUCTOR 22UH
	E805	2995604	8P SUB MINI CONN W/WIRE L = 350		L901	2272391	LINE FILTER (C2178FS-191/L/2, C2176PX-981, C2173MS-191/L/2, C2172MS-191/L/2)
	E900	2783981	LEAD PIN L		L901	2122694	LINE FILTER (C2173MS-192R, C2172MS-192R/981R)
	E903	2972581	POWER CORD (C2178FS-191/L/2, C2176PX-981, C2173MS-191/L/2, C2172MS-191/L/2)		L902	BV00175	COIL 220UH
	E903	2972591A	POWER CORD CEE (C2173MS-192R, C2172MS-192R/981R)		L951	2123781R	PEAKING COIL 100UH-K
	E904	2661753	4P PLUG PIN WITH BASE		L952	2123781R	PEAKING COIL 100UH-K
	E906L	2729252R	FUSE HOLDER		L953	2123781R	PEAKING COIL 100UH-K
	E906R	2729252R	FUSE HOLDER		L954	2123781R	PEAKING COIL 100UH-K
	E907	2995909	2I PROCESSED WIRE WITH JST PIN (C2178FS-191/L/2, C2176PX-981, C2173MS-191/L/2, C2172MS-191/L/2)		MF401	2167311B	CERAMIC FILTER 4 5MHZ (C2178FS, C2176PX)
	E950	3763752	SK BINDER 200		MF402	2167211B	CERAMIC FILTER 5 5MHZ
	E990	2998585	CONNECTOR W/WIRE (C2178MS-192R, C2172MS-192R/981R)		MF403	2167212B	CERAMIC FILTER 6 0MHZ
	E991	2957687	CONNECTOR W/WIRE (C2178MS-192R, C2172MS-192R/981R)		MF404	2167213B	CERAMIC FILTER 6 5MHZ
	E992	2667149A	1J MINI CONNECTOR W/WIRE (C2173MS-192R, C2172MS-192R/981R)		MF501	BN00171	CER TRAP 5 5/5 74MHZ
	EM	2665272A	4P PLUG PIN W/BASE (UL) TAIKO		MF502	BN00172	CER TRAP 6 0/6 5MHZ
	F901	2721615	FUSE 3 15A		MF503	2123451	CERAMIC TRAP 4 5MHZ (C2178FS, C2176PX)
	FB1101	2771892	FERRITE BEADS CORE (004)		N905	4334011	TRS HEAT SINK PIECE
	FB781	2122653M	FERRITE CORE WITH LEAD		PR952	AZ00104M	2A PROTECTOR
	FB901	2123468M	FERRITE CORE WITH LEAD 0 8UH		Q101	2326875R	TRS DTC144WS
	FB902	2123468M	FERRITE CORE WITH LEAD 0 8UH		Q102	2326875R	TRS DTC144WS
	FB903	2123468M	FERRITE CORE WITH LEAD 0 8UH		Q1101	CF01421	TRS KTC3198 GR
	FB951	2123462M	FERRITE BEADS CORE B 2 3UH		Q1102	CF1421R	TRS KTC3198 GR
	FB952	2123462M	FERRITE BEADS CORE B 2 3UH		Q1104	CF1421R	TRS KTC3198 GR
	FB953	2123462M	FERRITE BEADS CORE B 2 3UH		Q1105	CP02871R	IC KIA70429
	FB954	2123462M	FERRITE BEADS CORE B 2 3UH		Q1106	CF01421R	TRS KTC3198 GR
	IC1101	CP04192	CPU IC M37212M6-111SP		Q201	CF01011R	TRS (KEC) KTC3198
	IC1102	CP03981	IC S24C084DPA-01		Q203	2326875R	TRS DTC144WS (C2178FS, C2176PX)
	IC201	2004415	IC TDA8362/N5		Q204	2326875R	TRS DTC144WS (C2178FS, C2176PX)
	IC402	2004362	IC CXA1279AS		Q205	2326875R	TRS DTC144WS (C2178FS, C2176PX)
	IC4501	2004022	IC AN7147N		Q301	CF01431R	TRS KTA 1266Y
	IC451	2020601	IC MM1053XS		Q303	2326875R	TRS DTC144WS
	IC501	CP02611A	IC U3665M		Q401	CF01421R	TRS KTC3198 GR
	IC502	2004431	IC TDA8395		Q4501	2326873R	TRS DTC144ES (C2178FS, C2176PX)
	IC681	2020631	IC AN5515		Q4503	CF01421R	TRS KTC3198 GR
	IC901	2917783	IC CNX82A 300		Q4504	CF01421R	TRS KTC3198 GR
	L101	2122253M	AXIAL COIL LAL04 100UH-K		Q501	CF01421R	TRS KTC3198 GR
	L1101	2123739R	COIL EL0405 1 0UH-K		Q502	CF01421R	TRS KTC3198 GR (C2178FS, C2176PX)
	L1103	2122956M	AXIAL COIL LAL03 100UH-K		Q506	CF01421R	TRS KTC3198 GR
	L201	2123103M	AXIAL COIL LAL02 10UH-K (C2178FS, C2176PX)		Q507	CF01431R	TRS KTA 1266Y
					Q721	CF01061R	TRS MPSA42
					Q723	CF01041R	TRS KTC3205



# REPLACEMENT PARTS LIST

**PRODUCT SAFETY NOTE :** Components marked with a  have special characteristics important to safety. Before replacing any of these components, read carefully the **PRODUCT SAFETY NOTICE** of this Service Manual. Don't degrade of the receiver through improper servicing

CP	CCT No	PARTS No	DESCRIPTION	CP	CCT No	PARTS No	DESCRIPTION
	Q724	CF01431R	TRS KTA 1266Y		R1132	0700046M	RES CAR FILM 1/16 2 7K-J
	Q781	2315161	TRS BU2508DF		R1133	0700053M	RES CAR FILM 1/16 8 2K-J
	Q801	CF01431R	TRS KTA 1266Y		R1134	0700039M	RES CAR FILM 1/16 820K-J
	Q851	CF00951	TRS KTC 3229		R1135	0700054M	RES CAR FILM 1/16 10K-J
	Q852	CF00951	TRS KTC 3229		R1136	0700054M	RES CAR FILM 1/16 10K-J
	Q853	CF00951	TRS KTC 3229		R1137	0700045M	RES CAR FILM 1/16 2 2K-J
	Q901	CF01431R	TRS KTA 1266Y		R1138	0700054M	RES CAR FILM 1/16 10K-J
	Q902	2312971R	TRS BC368		R1139	0700055M	RES CAR FILM 1/16 12K-J
	Q903	2314792	TRS. BUT12AF/ON4959		R1139A	0700039M	RES CAR FILM 1/16 820-J
	Q904	CF01421R	TRS KTC3198 GR		R1140	0700054M	RES CAR FILM 1/16 10K-J
	Q905	CF01451	TRS KTC 4369		R1141	0700055M	RES CAR FILM 1/16 12K-J
	Q951	CF01051R	TRS KTC 3200 GR		R1142	0700052M	RES CAR FILM 1/16 6 8K-J
	Q952	CF01421R	TRS KTC3198 GR		R1143	0700055M	RES CAR FILM 1/16 12K-J
	Q953	CF01431R	TRS KTC 1266Y		R1144	0700052M	RES CAR FILM 1/16 6 8K-J
	Q954	CF01421R	TRS KTC3198 GR		R1145	0700052M	RES CAR FILM 1/16 6 8K-J
	Q955	CJ00161R	TRS BT149-B		R1146	0700047M	RES CAR FILM 1/16 3 3-J
	Q956	CF01421R	TRS KTC3198 GR		R1147	0700027M	RES CAR FILM 1/16 100-J
	Q957	CF01231	TRS BD330		R1148	0700027M	RES CAR FILM 1/16 100-J
	Q958	CF01421R	TRS KTC3198 GR		R1149	0700041M	RES CAR FILM 1/16 1K-J
	R1001	0700041M	RES CAR FILM 1/16 1K-J		R1150	0700041M	RES CAR FILM 1/16 1K-J
	R101	0700058M	RES CAR FILM 1/16 22K-J		R1151	0700054M	RES CAR FILM 1/16 10K-J
	R102	0700054M	RES CAR FILM 1/16 10K-J		R1154	0700061M	RES CAR FILM 1/16 33K-J
	R103	0700054M	RES CAR FILM 1/16 10K-J		R1155	0700058M	RES CAR FILM 1/16 22K-J
	R1101	0110223S	RES MTL OXIDE 2W 120-J		R1156	0700058M	RES CAR FILM 1/16 22K-J
	R1102	0700051M	RES CAR FILM 1/16 5 6K-J		R1157	0700027M	RES CAR FILM 1/16 100-J
	R1103	0700027M	RES CAR FILM 1/16 100-J		R1158	0700027M	RES CAR FILM 1/16 100-J
	R1104	0700027M	RES CAR FILM 1/16 100-J		R1159	0700027M	RES CAR FILM 1/16 100-J
	R1106	0700041M	RES CAR FILM 1/16 1K-J		R1160	0700041M	RES CAR FILM 1/16 1K-J
	R1107	0700043M	RES CAR FILM 1/16 1 5K-J		R1161	0700041M	RES CAR FILM 1/16 1K-J
	R1108	0700058M	RES CAR FILM 1/16 22K-J		R1162	0700056M	RES CAR FILM 1/16 15K-J
	R1109	0700058M	RES CAR FILM 1/16 22K-J		R1163	0700056M	RES CAR FILM 1/16 15K-J
	R1110	0700058M	RES CAR FILM 1/16 22K-J		R1165	0700045M	RES CAR FILM 1/16 2 2K-J
	R1111	0700027M	RES CAR FILM 1/16 100-J		R1166	0700051M	RES CAR FILM 1/16 5 6K-J
	R1112	0700027M	RES CAR FILM 1/16 100-J		R1167	0700054M	RES CAR FILM 1/16 10K-J
	R1113	0700027M	RES CAR FILM 1/16 100-J		R1168	0700054M	RES CAR FILM 1/16 10K-J
	R1114	0700051M	RES CAR FILM 1/16 5 6K-J		R1169	0700062M	RES CAR FILM 1/16 39K-J
	R1115	0700051M	RES CAR FILM 1/16 5 6K-J		R1170	0700062M	RES CAR FILM 1/16 39K-J
	R1116	0700027M	RES CAR FILM 1/16 101-J (C2178FS, C2173MS)		R1171	0700056M	RES CAR FILM 1/16 15K-J
	R1117	0700027M	RES CAR FILM 1/16 101-J (C2178FS, C2173MS)		R1172	0700054M	RES CAR FILM 1/16 10K-J
	R1118	0700067M	RES CAR FILM 1/16 100K-J		R1176	0700054M	RES CAR FILM 1/16 10K-J
	R1119	0700038M	RES CAR FILM 1/16 680-J		R1177	0700058M	RES CAR FILM 1/16 22K-J
	R1120	0700035M	RES CAR FILM 1/16 390-J		R1180	0700041M	RES CAR FILM 1/16 1K-J
	R1121	0700035M	RES CAR FILM 1/16 390-J		R1181	0100123M	RES CAR FILM 1/8 270K-J
	R1123	0700041M	RES CAR FILM 1/16 1K-J		R1182	0700054M	RES CAR FILM 1/16 10K-J
	R1125	0700048M	RES CAR FILM 1/16 3 9K-J (C2178FS, C2173MS)		R1183	0700066M	RES CAR FILM 1/16 82K-J
	R1125	0700053M	RES CAR FILM 1/16 8 2K-J (C2176PX, C2172MS)		R1184	0700054M	RES CAR FILM 1/16 10K-J
	R1126	0700048M	RES CAR FILM 1/16 3 9K-J (C2178FS, C2173MS)		R1185	0700058M	RES CAR FILM 1/16 22K-J
	R1126	0700053M	RES CAR FILM 1/16 8 2K-J (C2176PX, C2172MS)		R1186	0700052M	RES CAR FILM 1/16 6 8K-J
	R1127	0700048M	RES CAR FILM 1/16 3 9K-J (C2178FS, C2173MS)		R1187	0700056M	RES CAR FILM 1/16 15K-J
	R1127	0700053M	RES CAR FILM 1/16 8 2K-J (C2176PX, C2172MS)		R1188	0700044M	RES CAR FILM 1/16 1 8K-J
	R1128	0700055M	RES CAR FILM 1/16 12K-J		R1189	0700051M	RES CAR FILM 1/16 5 6K-J
	R1129	0700054M	RES CAR FILM 1/16 10K-J		R1190	0700042M	RES CAR FILM 1/16 1 2K-J (C2176PX, C2172MS)
	R1130	0700054M	RES CAR FILM 1/16 10K-J		R1191	0700042M	RES CAR FILM 1/16 1 2K-J (C2176PX, C2172MS)
					R1192	0700042M	RES CAR FILM 1/16 1.2K-J (C2176PX, C2172MS)
					R1194	0700052M	RES CAR FILM 1/16 6 8K-J
					R1200	0700059M	RES CAR FILM 1/16 27K-J
					R1202	0700041M	RES CAR FILM 1/16 1K-J
					R1203	0700038M	RES CAR FILM 1/16 680-J









# REPLACEMENT PARTS LIST

**PRODUCT SAFETY NOTE** : Components marked with a  have special characteristics important to safety. Before replacing any of these components, read carefully the **PRODUCT SAFETY NOTICE** of this Service Manual. Don't degrade of the receiver through improper servicing

CP	CCT No	PARTS No	DESCRIPTION	CP	CCT No	PARTS No	DESCRIPTION
	R1213	0700054M	RES CAR FILM 1/16 10K-J		R440	0700043M	RES CAR FILM 1/16 1 5K-J
	R201	0700052M	RES CAR FILM 1/16 6 8K-J (C2178FS, C2176PX)		R441	0700043M	RES CAR FILM 1/16 1 5K-J
	R201	0700048M	RES CAR FILM 1/16 3 9K-J (C2173MS, C2172MS)		R443	0119687M	RES MTL OXIDE 1/4 4 7-J
	R202	0700042M	RES CAR FILM 1/16 1 2K-J (C2178FS, C2176PX)		R4503	0700067M	RES CAR FILM 1/16 100K-J
	R202	0700038M	RES CAR FILM 1/16 680-J (C2173MS, C2172MS)		R4504	0700059M	RES CAR FILM 1/16 27K-J
	R203	0100047M	RES CAR FILM 1/8 180-J (C2178FS, C2176PX)		R4505	0700041M	RES CAR FILM 1/16 1K-J
	R204	0700019M	RES CAR FILM 1/16 27-J		R4506	0700033M	RES CAR FILM 1/16 270-J (C2178FS, C2176PX)
	R205	0700031M	RES CAR FILM 1/16 180-J (C2173MS, C2172MS)		R4506	0700034M	RES CAR FILM 1/16 330-J (C2173MS, C2176PX)
	R207	0700054M	RES CAR FILM 1/16 10K-J		R4507	0700033M	RES CAR FILM 1/16 270-J (C2178FS, C2176PX)
	R208	0700027M	RES CAR FILM 1/16 100-J		R4507	0700034M	RES CAR FILM 1/16 330-J (C2173MS, C2172MS)
	R209	0700064M	RES CAR FILM 1/16 56K-J		R4508	0700041M	RES CAR FILM 1/16 1K-J
	R210	0700058M	RES CAR FILM 1/16 22K-J		R4509	0700041M	RES CAR FILM 1/16 1K-J
	R214	0700058M	RES CAR FILM 1/16 22K-J		R451	0700047M	RES CAR FILM 1/16 3 3K-J
	R215	0700026M	RES CAR FILM 1/16 82-J		R451A	0700035M	RES CAR FILM 1/8 56-J
	R221	0700045M	RES CAR FILM 1/16 2.2K-J (C2178FS, C2176PX)		R502	0700031M	RES CAR FILM 1/16 180-J
	R230	0700041M	RES CAR FILM 1/16 1K-J (C2178FS, C2176PX)		R503	0700033M	RES CAR FILM 1/16 270-J (C2178FS, C2176PX)
	R231	0700041M	RES CAR FILM 1/16 1K-J (2178FS, C2176PX)		R504	0700045M	RES CAR FILM 1/16 2 2K-J (C2178FS, C2176PX)
	R232	0700054M	RES CAR FILM 1/16 10K-J (C2178FS, C2176PX)		R505	0700057M	RES CAR FILM 1/8 470-J
	R234	0700054M	RES CAR FILM 1/16 10K-J (C2178FS, C2176PX)		R506	0700045M	RES CAR FILM 1/16 2 2K-J
	R240	0119687G	RES CAR FILM 1/4 4 7-J		R507	0700034M	RES CAR FILM 1/16 330-J
	R250	0100049M	RES CAR FILM 1/8 220K-J		R508	0700052M	RES CAR FILM 1/16 6 8K-J
	R260	0700041M	RES CAR FILM 1/16 1K-J		R509	0700067M	RES CAR FILM 1/16 100K-J
	R302	0700038M	RES CAR FILM 1/8 75-J		R511	0100041M	RES CAR FILM 1/8 100-J
	R303	0700027M	RES CAR FILM 1/16 100-J		R513	0100041M	RES CAR FILM 1/8 100-J
	R304	0700067M	RES CAR FILM 1/16 100K-J		R515	0100041M	RES CAR FILM 1/8 100-J
	R305	0700058M	RES CAR FILM 1/16 22K-J		R519	0100057M	RES CAR FILM 1/8 470-J
	R306	0700067M	RES CAR FILM 1/16 100K-J		R529	0700027M	RES CAR FILM 1/16 100-J (C2178FS, C2176PX)
	R307	0700027M	RES CAR FILM 1/16 100-J		R530	0700029M	RES CAR FILM 1/16 150-J
	R308	0700025M	RES CAR FILM 1/16 68-J		R531	0700032M	RES CAR FILM 1/16 220-J
	R309	0100045M	RES CAR FILM 1/8 150-J		R532	0700031M	RES CAR FILM 1/16 180-J
	R310	0700027M	RES CAR FILM 1/16 100-J		R533	0700032M	RES CAR FILM 1/16 220-J
	R312	0700067M	RES CAR FILM 1/16 100K-J		R534	0700032M	RES CAR FILM 1/16 220-J
	R314	0700067M	RES CAR FILM 1/16 100K-J		R535	0700032M	RES CAR FILM 1/16 220-J
	R315	0700027M	RES CAR FILM 1/16 100-J		R536	0700051M	RES CAR FILM 1/16 5 6K-J
	R320	0700067M	RES CAR FILM 1/16 100K-J		R537	0700032M	RES CAR FILM 1/16 220-J
	R321	0700037M	RES CAR FILM 1/16 560-J (C2178FS, C2173MS)		R538	0700064M	RES CAR FILM 1/16 56K-J
	R321	0700034M	RES CAR FILM 1/16 330-J (C2176PX, C2172MS)		R539	0700032M	RES CAR FILM 1/16 220-J
	R332	0700057M	RES CAR FILM 1/16 18K-J		R540	0700063M	RES CAR FILM 1/16 47K-J
	R333	0700027M	RES CAR FILM 1/16 100-J		R541	0700059M	RES CAR FILM 1/16 27K-J
	R401	0700035M	RES CAR FILM 1/16 390-J		R570	0700027M	RES CAR FILM 1/16 100-J
	R402	0700058M	RES CAR FILM 1/16 22K-J		R571	0100053M	RES CAR FILM 1/8 330-J
	R403	0700054M	RES CAR FILM 1/16 10K-J		R590	0119508S	RES MTL FILM 1/4 56-J
	R404	0100001M	RES CAR FILM 1/8 2.2-J		R602	0100133M	RES CAR FILM 1/8 680K-J
	R405	0100001M	RES CAR FILM 1/8 2.2-J		R604	0700051M	RES CAR FILM 1/16 5 6K-J
	R410	0700037M	RES CAR FILM 1/16 560-J		R605	0700054M	RES CAR FILM 1/16 10K-J
	R411	0700037M	RES CAR FILM 1/16 560-J		R606	0700055M	RES CAR FILM 1/16 12K-J
	R419	0700054M	RES CAR FILM 1/16 10K-J		R607	0700029M	RES CAR FILM 1/16 150-J
	R427	0700041M	RES CAR FILM 1/16 1K-J		R608	0700049M	RES CAR FILM 1/16 4 7K-J
					R609	0119844M	RES MTL FILM 1W 2 2-J
					R612	0113748M	RES CAR FILM 1/2 820-J
					R613	0700048M	RES CAR FILM 1/16 3 9K-J
					R620	0700067M	RES CAR FILM 1/16 100K-J
					R681	0113735M	RES CAR FILM 1/2 270-J
					R701	0700061M	RES CAR FILM 1/16 33K-J
					R703	0700034M	RES CAR FILM 1/16 330-J
					R705	0700061M	RES CAR FILM 1/16 33K-J

# REPLACEMENT PARTS LIST

**PRODUCT SAFETY NOTE :** Components marked with a  have special characteristics important to safety. Before replacing any of these components, read carefully the **PRODUCT SAFETY NOTICE** of this Service Manual. Don't degrade of the receiver through improper servicing

CP	CCT No	PARTS No	DESCRIPTION	CP	CCT No	PARTS No	DESCRIPTION
	R706	0700059M	RES CAR FILM 1/16 27K-J		R914	0114013M	RES CAR FILM 1/4 6 8-J
	R707	0700045M	RES CAR FILM 1/16 2 2K-J		R915	0114161M	RES CAR FILM 1/4 1K-J
	R710	0100119M	RES CAR FILM 1/8 180K-J		R916	0114169M	RES CAR FILM 1/4 2 2K-J
	R711	0100123M	RES CAR FILM 1/8 270K-J		R917	0100041M	RES CAR FILM 1/8 100-J
	R712	0700069M	RES CAR FILM 1/16 150K-J		R918	0112791M	RES CAR FILM 1/2 47K-J
	R712A	0700076M	RES CAR FILM 1/16 470K-J		R919	0110221	RES MTL OXIDE 2W 100-J
	R720	0110259S	RES MTL OXIDE 3W 3 9K-J		R920	0110137	RES MTL OXIDE 1W 470-J
	R723	0100049M	RES CAR FILM 1/8 220-J		R921	0110145	RES MTL OXIDE 1W 1K-J
	R724	0700041M	RES CAR FILM 1/16 1K-J		R940	0110217S	RES MTL OXIDE 2W 68-J
	R725	0700054M	RES CAR FILM 1/16 10K-J		R951	0700032M	RES CAR FILM 1/16 220-J
	R726	0700063M	RES CAR FILM 1/16 47K-J		R952	0700041M	RES CAR FILM 1/16 1K-J
	R727	0700054M	RES CAR FILM 1/16 10K-J		R953	0700045M	RES CAR FILM 1/16 2 2K-J
	R730	0700047M	RES CAR FILM 1/16 3 3K-J		R954	0100065M	RES CAR FILM 1/8 1K-J
	R733	0100051M	RES CAR FILM 1/8 270-J		R955	0700039M	RES CAR FILM 1/16 820-J
	R751	0114223M	RES CAR FILM 1/4 82K-J		R956	0700029M	RES CAR FILM 1/16 150-J
	R752	0114223M	RES CAR FILM 1/4 82K-J		R957	0113754M	RES CAR FILM 1/2 1 5-J
	R757	0118970M	RES MTL FILM 1/4 240K-F		R958	0700049M	RES CAR FILM 1/16 4 7K-J
	R758	0119647M	RES MTL FILM 1/8 47K-F		R959	0700049M	RES CAR FILM 1/16 4 7K-J
	R759	0110279S	RES MTL OXIDE 2W 27K-J		R960	0700049M	RES CAR FILM 1/16 4.7K-J
	R760	0700041M	RES CAR FILM 1/16 1K-J		R961	0700049M	RES CAR FILM 1/16 4 7K-J
	R761	0700041M	RES CAR FILM 1/16 1K-J		R962	0113791M	RES CAR FILM 1/2 47K-J
	R762	0100073M	RES CAR FILM 1/8 2 2K-J		R964	0100078M	RES CAR FILM 1/8 3.6K-J
	R764	0119505S	RES CAR FILM 1/4 2 2-J		R965	0700046M	RES CAR FILM 1/16 2 7K-J
	R768	0100077M	RES CAR FILM 1/8 3 3K-J		R966	0113789M	RES CAR FILM 1/2 39K-J
	R781	0147626A	RES WIRE WOUND 7W 4 7-K		R967	0110155S	RES MTL OXIDE 1W 2 7K-J
	R782	0113748M	RES CAR FILM 1/2 820-J		R968	0110135S	RES MTL OXIDE 1W 390-J
	R801	0700027M	RES CAR FILM 1/16 100-J		R969	0700054M	RES CAR FILM 1/16 10K-J
	R802	0700027M	RES CAR FILM 1/16 100-J		R970	0700049M	RES CAR FILM 1/16 4 7K-J
	R803	0700027M	RES CAR FILM 1/16 100-J		R971	0700034M	RES CAR FILM 1/16 330-J
	R804	0700033M	RES CAR FILM 1/16 270-J		R998	0174704	RES MTL OXIDE 1W 10M-J
	R805	0700035M	RES CAR FILM 1/16 390-J		RK002	0700032M	RES CAR FILM 1/16 220-J
	R806	0700033M	RES CAR FILM 1/16 270-J		RK171	0700032M	RES CAR FILM 1/16 220-J
	R807	0700044M	RES CAR FILM 1/16 1 8K-J		RK259	0100041M	RES CAR FILM 1/8W 100-JB (C2178FS)
	R808	0700044M	RES CAR FILM 1/16 1 8K-J		RK269	0100041M	RES CAR FILM 1/8W 100-JB (C2178FS)
	R809	0700044M	RES CAR FILM 1/16 1 8K-J		S1101	2632851A	5KEY TACT SWITCH (JEIL)
	R811	0110271S	RES MTL OXIDE 2W 12K-J		S901	2634731	POWER SWITCH (SDDFA3)
	R812	0110271S	RES MTL OXIDE 2W 12K-J		T721	2260221A	HOR DRIVE TRANSFORMER
	R813	0110271S	RES MTL OXIDE 2W 12K-J		T761	BW00302	FBT
	R814	0113744M	RES CAR FILM 1/2 560-J		T901	BT00701	SWITCHING TRANSFORMER
	R815	0113744M	RES CAR FILM 1/2 560-J		TH901	CJ00131	PTC THERMISTOR (PHILIPS)
	R816	0113744M	RES CAR FILM 1/2 560-J		U001	HJ00211	TUNER ET-555SU
	R817	0700037M	RES CAR FILM 1/16 560-J		VR202	0150265	RES VARIABLE RV6 10K-B
	R818	0700037M	RES CAR FILM 1/16 560-J		VR601	AW00121	RES VARIABLE RV6 500-B
	R819	0700037M	RES CAR FILM 1/16 560-J		VR701	AW00077	RES VARIABLE RV6 10K-B
	R820	0700045M	RES CAR FILM 1/16 2 2K-J		VR801	AW00073	TRIMMER RESISTOR
	R821	0700054M	RES CAR FILM 1/16 10K-J		VR802	AW00073	TRIMMER RESISTOR
	R822	0700054M	RES CAR FILM 1/16 10K-J		VR803	AW00073	TRIMMER RESISTOR
	R823	0700054M	RES CAR FILM 1/16 10K-J		VR804	AW00072	TRIMMER RESISTOR
	R850	0100041M	RES CAR FILM 1/8 100-J		VR806	AW00072	TRIMMER RESISTOR
	R901	0147614AX	RES WIRE WOUND 7W 1 5-K		VR951	AW00102	RES VARIABLE RV6 1K-B
	R901A	0147616A	RES WIRE WOUND 7W 1 8-K		W001	1EK2018	2J SHIELD CABLE (C2178FS, C2173MS)
	R902	0112787M	RES CAR FILM 1/2 33K-J		W101	9374592	SOLDER COATED WIRE AWG 22 UL 1007 BLACK
	R903	0100085M	RES CAR FILM 1/8 6 8K-J		W102	9374592	SOLDER COATED WIRE AWG 22 UL 1007 BLACK
	R906	0114165M	RES CAR FILM 1/4 1 5K-J		W103	9374592	SOLDER COATED WIRE AWG 22 UL 1007 BLACK
	R907	0110223	RES MTL OXIDE 2W 120-J		WR470	9374592	SOLDER COATED WIRE AWG 22 UL 1007 BLACK
	R908	0100089M	RES CAR FILM 1/8 10K-J		X1101	2168371	X'TAL CST 6 0MHZ
	R909	0700059M	RES CAR FILM 1/16 27K-J		X501	2791505A	CRYSTAL 3 58MHZ
	R910	0700041M	RES CAR FILM 1/16 1K-J				
	R911	0700021M	RES CAR FILM 1/16 33-J				
	R912	0114131M	RES CAR FILM 1/4 100-J				
	R913	0700032M	RES CAR FILM 1/16 220-J				

# REPLACEMENT PARTS LIST

**PRODUCT SAFETY NOTE** : Components marked with a  $\Delta$  have special characteristics important to safety. Before replacing any of these components, read carefully the **PRODUCT SAFETY NOTICE** of this Service Manual. Don't degrade of the receiver through improper servicing

CP	CCT No	PARTS No	DESCRIPTION	CP	CCT No	PARTS No	DESCRIPTION
$\Delta$	X503	2170043A	CRYSTAL X'TA 4 43 (H K )				0204249C (C2178FS)
	ZD1001	2339819M	ZENER DIODE HZS3C3	C1618		0880012R	MYLAR CAPACITOR 0 022U
	ZD1101	2339837M	ZENER DIODE HZS5C1				0204249C (C2178FS)
	ZD1120	2339812M	ZENER DIODE HZS3A2	C1619		0880016R	CAP-POLYESTER FILM 0 1UF 50V
	ZD201	2339889M	ZENER DIODE HZS12C3				(C2178FS)
	ZD501	2331795M	ZENER DIODE HZ5B2	C1620		0800007R	CAP-ELECTRO 3 3UF-M 50V
	ZD503	2339869M	ZENER DIODE HZS9C3				(C2178FS)
	ZD610	2339231M	ZENER DIODE HZS30-1L	C1621		0800047R	CAP-ELECTRO 100UF-M 6 3V
	ZD611	2339231M	ZENER DIODE HZS30-1L				(C2178FS)
	ZD701	2331817M	ZENER DIODE HZ7C1	C1622		0880016R	CAP-POLYESTER FILM 0 1UF 50V
	ZD721	2339843M	ZENER DIODE HZS6A3				(C2178FS)
	ZD751	2339222M	ZENER DIODE HZS27-2L	C1623		0800007R	CAP-ELECTRO. 3 3UF-M 50V
	ZD753	2339867M	ZENER DIODE HZS9C1				(C2178FS)
	ZD754	2335991M	ZENER DIODE HZT33-02	C1624		0880016R	CAP-POLYESTER FILM 0 1UF 50V
	ZD755	2339812M	ZENER DIODE HZS3A2				(C2178FS)
	ZD810	2331797M	ZENER DIODE HZ5C1	C1625		0800047R	CAP-ELECTRO 100UF-M 6 3V
	ZD810A	2331836M	ZENER DIODE HZ11B3				(C2178FS)
	ZD901	2339819M	ZENER DIODE HZS3C3	C1626		0800015R	CAP-ELECTRO 10UF-M 16V
	ZD902	2339825M	ZENER DIODE HZS4B2				(C2178FS)
	ZD903	2339889M	ZENER DIODE HZS12C3	C1627		0800015R	CAP-ELECTRO 10UF-M 16V
	ZD904	2339835M	ZENER DIODE HZS5B2				(C2178FS)
	ZD905	2339842M	ZENER DIODE HZS6A2	C1628		0800015R	CAP-ELECTRO 10UF-M 16V
	ZD951	2339853M	ZENER DIODE HZS7A3				(C2178FS)
	ZD952	2339893M	ZENER DIODE HZS 15-3	C1629		0880011R	MYLAR CAPACITOR 0 015UF
	ZD953	2339847M	ZENER DIODE HZS6C1				(C2178FS)
	ZD954	2339869M	ZENER DIODE HZS9C3	C1630		0800041R	CAP-ELECTRO 47UF-M 16V
	#0102	NA00131	BRACKET (C2178FS)				(C2178FS)
	B1601	JK00301	KARAOK PWB (C2178FS)	C1631		0800012R	CAP-ELECTRO 4 7UF-M 50V
	C1601	0890087R	CAP.-CERAMIC 1000PF-K 50V				(C2178FS)
				C1632		0800015R	CAP-ELECTRO 10UF-M 16V
	C1602	0800015R	CAP-ELECTRO 10UF-M 16V				(C2178FS)
				C1633		0800015R	CAP-ELECTRO 10UF-M 16V
	C1603	0800015R	CAP-ELECTRO. 10UF-M 16V				(C2178FS)
				C1634		0800015R	CAP-ELECTRO 10UF-M 16V
	C1604	0800049R	CAP-ELECTRO 100UF-M 16V				(C2178FS)
				C1635		0800015R	CAP-ELECTRO. 10UF-M 16V
	C1605	0800003R	CAP.-ELECTRO 1 0UF-M 50V				(C2178FS)
				C1636		0800015R	CAP-ELECTRO 10UF-M 16V
	C1606	0800032R	CAP-ELECTRO. 33UF-M 16V				(C2178FS)
				C1637		0800015R	CAP-ELECTRO 10UF-M 16V
	C1607	0800003R	CAP-ELECTRO 1 0UF-M 50V				(C2178FS)
				C1638		0880012R	MYLAR CAPACITOR 0 022U
	C1608	0880016R	CAP.-POLYESTER FILM 0 1UF 50V				(C2178FS)
				C1639		0800048R	CAP-ELECTRO 100UF-M 10V
	C1609	0244107R	CAP.-CERAMIC 3300PF-K 50V TAPE				(C2178FS)
				C1640		0800081	CAP-ELECTRO 1000UF-M 10V
	C1610	0244107R	CAP.-CERAMIC 3300PF-K 50V TAPE				(C2178FS)
			D1601		2338321M	DIODE 1SS270 (TA) (C2178FS)	
C1611	0880008R	MYLAR CAPACITOR 6800PF-K 50V	E1601		EF00591	4J-5J EH CONNECTOR L = 200	
						(C2178FS)	
C1612	0244103R	CAPACITOR CERAMIC 0 0015UF-K B50WV (C2178FS)	IC1601		CP00131U	ANALOG MONOLITHIC IC(CXA1643P)	
						(C2178FS)	
C1613	0248696R	CAPACITOR CERAMIC 330PF-J SL 50 (C2178FS)	IC1602		CP00141U	DIGITAL MONOLITHIC IC(CXA1644P)	
						(C2178FS)	
C1614	0249093R	CAPACITOR CERAMIC 470PF-J SL 50WV (C2178FS)	IC1603		2362606	IC NJM4558D (C2178FS)	
			JA1601		2677756	MIC JACK (C2178FS)	
C1615	0249093R	CAPACITOR CERAMIC 470PF-J SL 50WV (C2178FS)	Q1601		2327773M	TRS 2SC3413 TAPE S1	
						200MHZ300MW (C2178FS)	
C1616	0880016R	CAP.-POLYESTER FILM 0.1UF 50V (C2178FS)	Q1602		2327773M	TRS. 2SC3413 TAPE S1	
						200MHZ300MW (C2178FS)	
C1617	0880012R	MYLAR CAPACITOR 0.022U	Q1603		2327773M	TRS. 2SC3413 TAPE S1	





# REPLACEMENT PARTS LIST

**PRODUCT SAFETY NOTE :** Components marked with a  $\Delta$  have special characteristics important to safety. Before replacing any of these components, read carefully the **PRODUCT SAFETY NOTICE** of this Service Manual. Don't degrade of the receiver through improper servicing

CP	CCT No	PARTS No	DESCRIPTION	CP	CCT No	PARTS No	DESCRIPTION
	Q1604	2327773M	200MHZ300MW. (C2178FS) TRS 2SC3413 TAPE S1		R1634	0700067M	(C2178FS) RES -CARBON FLM 1/16W 100K-JB (C2178FS)
	Q1605	2327773M	200MHZ300MW (C2178FS) TRS 2SC3413 TAPE S1		R1635	0700045M	RES -CARBON FLM 1/16W 2 2K-JB (C2178FS)
	Q1606	2320644	200MHZ300MW (C2178FS) TRS 2SC1213 (D) S1 80MHZ400MW (C2178FS)		R1636	0700077M	RES -CARBON FLM 1/16W 560K-J (C2178FS)
	R1601	0100065M	RES -CARBON FLM 1/8W 1K-JB (C2178FS)		R1637	0700047M	RES -CARBON FLM 1/16W 3 3K-JB (C2178FS)
	R1602	0100065M	RES -CARBON FLM 1/8W 1K-JB (C2178FS)		R1638	0700043M	RES -CARBON FLM 1/16W 1 5K-JB (C2178FS)
	R1603	0700054M	RES -CARBON FLM 1/16W 10K-JB (C2178FS)		R1639	0700059M	RES -CARBON FLM 1/16W 27K-JB (C2178FS)
	R1604	0700058M	RES -CARBON FLM 1/16W 22K-JB (C2178FS)		R1640	0700054M	RES -CARBON FLM 1/16W 10K-JB (C2178FS)
	R1605	0700054M	RES -CARBON FLM 1/16W 10K-JB (C2178FS)		R1641	0700027M	RES -CARBON FLM 1/16W 100-JB (C2178FS)
	R1606	0700061M	RES -CARBON FLM 1/16W 33K-JB (C2178FS)		R1642	0700041M	RES -CARBON FLM 1/16W 1 0K-JB (C2178FS)
	R1607	0700054M	RES -CARBON FLM 1/16W 10K-JB (C2178FS)		R1643	0700064M	RES -CARBON FLM 1/16W 56K-JB (C2178FS)
	R1608	0700058M	RES -CARBON FLM 1/16W 22K-JB (C2178FS)		R1644	0700041M	RES -CARBON FLM 1/16W 1 0K-JB (C2178FS)
	R1609	0700054M	RES -CARBON FLM 1/16W 10K-JB (C2178FS)		R1645	0700049M	RES -CARBON FLM 1/16W 4 7K-JB (C2178FS)
	R1610	0700061M	RES -CARBON FLM 1/16W 33K-JB (C2178FS)		R1646	0700054M	RES -CARBON FILM 1/16W 10K-JB (C2178FS)
	R1611	0700061M	RES -CARBON FLM 1/16W 33K-JB (C2178FS)		R1647	0158253	RES -VARIABLE 10K-B (C2178FS)
	R1612	0700061M	RES -CARBON FLM 1/16W 33K-JB (C2178FS)		R1648	0700059M	RES -CARBON FILM 1/16W 27K-JB (C2178FS)
	R1614	0700064M	RES -CARBON FLM 1/16W 56K-JB (C2178FS)		R1649	0700065M	RES -CARBON FILM 1/16W 68K-JB (C2178FS)
	R1616	0700063M	RES -CARBON FLM 1/16W 47K-JB (C2178FS)		B001	JK04051A	PWB B/W PinP (C2178FS C2173MS)
	R1617	0700061M	RES -CARBON FLM 1/16W 33K-JB (C2178FS)		C001	0800047R	ELECT CAP SME 100UF 6 3V (C2178FS, C2173MS)
	R1621	0700041M	RES -CARBON FLM 1/16W 1 0K-JB (C2178FS)		C002	0890087R	CAR CAP B 1000PF-K 50V (C2178FS, C2173MS)
	R1622	0700041M	RES -CARBON FLM 1/16W 1 0K-JB (C2178FS)		C003	0880057R	POLY CAP B(F) 0 1UF-K 50V (C2178FS, C2173MS)
	R1623	0700064M	RES -CARBON FLM 1/16W 56K-JB (C2178FS)		C004	0880057R	POLY CAP B(F) 0 1UF-K 50V (C2178FS, C2173MS)
	R1624	0700049M	RES -CARBON FLM 1/16W 4 7K-JB (C2178FS)		C005	0880057R	POLY CAP B(F) 0 1UF-K 50V (C2178FS, C2173MS)
	R1625	0700064M	RES -CARBON FLM 1/16W 56K-JB (C2178FS)		C006	0880057R	POLY CAP B(F) 0 1UF-K 50V (C2178FS, C2173MS)
	R1627	0700027M	RES -CARBON FLM 1/16W 100-JB (C2178FS)		C007	0880057R	POLY CAP B(F) 0 1UF-K 50V (C2178FS, C2173MS)
	R1628	0700027M	RES -CARBON FLM 1/16W 100-JB (C2178FS)		C008	0800044R	ELECT CAP SME 47UF 50V (C2178FS, C2173MS)
	R1629	0700045M	RES -CARBON FLM 1/16W 2 2K-JB (C2178FS)		C009	0880057R	POLY CAP B(F) 0 1UF-K 50V (C2178FS, C2173MS)
	R1630	0700045M	RES -CARBON FLM 1/16W 2.2K-JB (C2178FS)		C010	0880057R	POLY CAP B(F) 0 1UF-K 50V (C2178FS, C2173MS)
	R1631	0700045M	RES -CARBON FLM 1/16W 2 2K-JB (C2178FS)		C011	0880057R	POLY CAP B(F) 0 1UF-K 50V (C2178FS, C2173MS)
	R1632	0700045M	RES -CARBON FLM 1/16W 2 2K-JB (C2178FS)		C012	0880057R	POLY CAP B(F) 0 1UF-K 50V (C2178FS, C2173MS)
	R1633	0700041M	RES -CARBON FLM 1/16W 1 0K-JB		C013	0880057R	POLY CAP B(F) 0 1UF-K 50V (C2178FS, C2173MS)
					C014	0890061R	CER CAP SL 10PF-D 50V (C2178FS,

# REPLACEMENT PARTS LIST

**PRODUCT SAFETY NOTE :** Components marked with a  have special characteristics important to safety. Before replacing any of these components, read carefully the **PRODUCT SAFETY NOTICE** of this Service Manual. Don't degrade of the receiver through improper servicing

CP	CCT No	PARTS No	DESCRIPTION	CP	CCT No	PARTS No	DESCRIPTION
	C015	0890076R	C2173MS) CER CAP B 150PF-K 50V (C2178FS, C2173MS)		R019	0700062M	C2173MS) RES CAR FLM 1/16 39K-J (C2178FS, C2173MS)
	C016	0890061R	CER CAP SL 10PF-D 50V (C2178FS, C2173MS)		R020	0700041M	RES CAR FLM 1/16 1K-J (C2178FS, C2173MS)
	C017	0880057R	POLY CAP B(F) 0 1UF-K 50V (C2178FS, C2173MS)		R021	0700032M	RES CAR FLM 1/16 220-J (C2178FS, C2173MS)
	C018	0800012R	ELECT CAP SMÈ 4 7UF 50V (C2178FS, C2173MS)		R022	0700067M	RES CAR FLM 1/16 100K-J (C2178FS, C2173MS)
	C019	0880057R	POLY CAP B(F) 0 1UF-K 50V (C2178FS, C2173MS)		R023	0700027M	RES CAR FLM 1/16 100-J (C2178FS, C2173MS)
	C020	0890089R	CER CAP B 0 0015UF-K 50V (C2178FS, C2173MS)		R024	0700027M	RES CAR FLM 1/16 100-J (C2178FS, C2173MS)
	C021	0890083R	CER CAP B 470PF-K 50V (C2178FS, C2173MS)		R025	0700041M	RES CAR FLM 1/16 1K-J (C2178FS, C2173MS)
	D001	2337341M	DIODE ISS270A (TP) (C2178FS, C2173MS)		R026	0700041M	RES CAR FLM 1/16 1K-J (C2178FS, C2173MS)
	E001	ED00372	13P PIN CONNECTOR (C2178FS, C2173MS)		RK006	0700041M	RES CAR FLM 1/16 1K-J (C2178FS, C2173MS)
	IC9060	CP04761	SAB9060 IC (B/W PinP) (C2178FS, 2173MS)		ZD001	2339837M	ZENER DIODE HZS5C1 (C2178FS, C2173MS)
	Q001	CF01421R	TRS KTC3198 (C2178FS, C2173MS)		B9001	JK00231A	LINE FILTER BOARD (C2173MS, C2172MS)
	Q002	CF01421R	TRS KTC3198 (C2178FS, C2173MS)		C9001	AJ00182F	CAPACITOR 1000PF / AC 250V (C2173MS, C2172MS)
	Q003	CF01421R	TRS KTC3198 (C2178FS, C2173MS)		C9001A	0262773	CAPACITOR 0.1UF / AC 250V (C2173MS, C2172MS)
	Q004	CF01431R	TRS KTA1266Y (C2178FS, C2173MS)		E9001	2665279	4P PLUG PINW-BASE (C2173MS, C2172MS)
	R001	0110207S	RES MTL OXIDE 2W 27-J (C2178FS, C2173MS)		E9002	2903543	3P PLUG PINW-BASE (C2173MS, C2172MS)
	R002	0700041M	RES CAR FLM 1/16 1K-J (C2178FS, C2173MS)		E9003	2903542	2P PLUG PINW-BASE (C2173MS, C2172MS)
	R003	0700041M	RES CAR FLM 1/16 1K-J (C2178FS, C2173MS)		L9001	2272391	LINE FILTER (C2173MS, C2172MS)
	R004	0700064M	RES CAR FLM 1/16 56K-J (C2178FS, C2173MS)		#0103	3333921	EARTH SPRING
	R005	0700033M	RES CAR FLM 1/16 270-J (C2178FS, C2173MS)		#0104	3763752	SK BINDER 200 NYLON 66
	R006	0700031M	RES CAR FLM 1/16 180-J (C2178FS, C2173MS)		#0135	9449506	SCOTH TAPE NO 29 19MM
	R007	0700061M	RES CAR FLM 1/16 33-J (C2178FS, C2173MS)		#0221	3763752	SK BINDER 200 NYLON 66
	R008	0700027M	RES CAR FLM 1/16 100-J (C2178FS, C2173MS)		E001	9449538	NITTO TAPE NO 5 W25 (BLACK)
	R009	0187038M	RES CAR FLM 1/16 75-J (C2178FS, C2173MS)		E0701	2788084	CRT EARTH WIRE 20INCH SF
	R010	0700039M	RES CAR FLM 1/16 820-J (C2178FS, C2173MS)		E701	2776242A	CONVERGENCE FREE MAGNET (30 2)
	R011	0700039M	RES CAR FLM 1/16 820-J (C2178FS, C2173MS)		L905	2276001A	DEGAUSSING COIL 21"4P CONN
	R012	0700039M	RES CAR FLM 1/16 820-J (C2178FS, C2173MS)		N01	4615641	WEDGE
	R013	0700054M	RES CAR FLM 1/16 10K-J (C2178FS, C2173MS)		U701	BY00682	DY-C90-21SF3
	R014	0700027M	RES CAR FLM 1/16 100-J (C2178FS, C2173MS)		V1	2471272	CPT A51KPD12XX
	R015	0700041M	RES CAR FLM 1/16 1K-J (C2178FS, C2173MS)		#0101	QD04631	FRAME ASS'Y C2178FS
	R016	0700067M	RES CAR FLM 1/16 100K-J (C2178FS, C2173MS)		#0102	QD04632	FRAME ASS'Y C2176PX
	R017	0700061M	RES CAR FLM 1/16 33K-J (C2178FS, C2173MS)		#0103	QD04633	FRAME ASS'Y C2173MS
	R018	0700067M	RES CAR FLM 1/16 100K-J (C2178FS, C2173MS)		#0105	QD04637	FRAME ASS'Y C2172MS
					#0110	QD04571	FRONT FRAME C2178FS (HB-MAT'L)
					#0111	QD04572	FRONT FRAME C2176PX, C2173MS C2172MS-192R (HB-MAT'L)
					#0113	3487484	HITACHI BADGE 55G PS
					#0126	3332453	E60 KNOB SPRING SUS 304
					#0128	PH04771	R/C LENS C2178FS
					#0130A	PM05241	SP NET C2178FS (R)

# REPLACEMENT PARTS LIST

**PRODUCT SAFETY NOTE** : Components marked with a  $\Delta$  have special characteristics important to safety. Before replacing any of these components, read carefully the **PRODUCT SAFETY NOTICE** of this Service Manual. Don't degrade of the receiver through improper servicing

CP	CCT No	PARTS No	DESCRIPTION	CP	CCT No	PARTS No	DESCRIPTION
	#0130B	PM05242	SP NET C2178FS (L)		#0192	PC02421	FUNCTION BUTTON C2178FS
	#0131	3760031	ADHESION PIECE (SMALL PIECE) (C2173MS/C2172MS-192R/981R)		#0194	4519512	4X16 B TAPPING SCREW STEEL
	#0138	4519512	4X16 B TAPPING SCREW STEEL		#0195	8815126	WASHER-4LOCKING
	#0148	PC02411	POWER BUTTON C2178FS		N	3705233	CLAMP ANODE
	#0150	QD00048	COVER ASS'Y S3-STEREO (V-0 MAT'L) (C2178FS-191/L, C2173MS-191/ 192R, C2172MS-192R)		RP401	0100089M	RES -CARBON FLM 1/8W 10K-JB
	#0151	QD00049	COVER ASS'Y S3-STEREO (H-B MAT'L) (C2178FS-192, C2176PX, C2173MS-192)		RP402	0100089M	RES -CARBON FLM 1/8W 10K-JB
	#0152	3875531	CORD HOLDER CT2043 NYLON		SP401	GK00242	SPEAKER 6X12 5W 4 OHM
	#0153	3165048	BACK COVER S3-STEREO (V-0 MAT'L) (C2178FS-191/L, C2173MS-191/ 192R C2172MS)		SP402	GK00242	SPEAKER 6X12 5W 4 OHM
	#0154	3165049	BACK COVER S3-STEREO (H-B MAT'L) (C2178FS-192, C2176PX, C2173MS-192/ 981, C2172MS-192)		WL	2976143	2P CONNECTOR WITH LEAD
	#0168	4519512	4X16 B TAPPING SCREW STEEL (C2173MS/C2172MS-192R/981R)		WP401	9374731	WIRE UL 1007 7/0 26 SN BLACK
	#0180	4518376	SCREW 6X25 TAPPING WITH WSR SAE		WP402	9374731	WIRE UL 1007 7/0 26 SN BLACK
	#0181	8781450	SCREW-3*20 TAPPING		WR	2976755	3P CONNECTOR WITH LEAD
	#0182	4519512	4X16 B TAPPING SCREW STEEL		ZP401	0544510	TERMINAL PIECE
	#0183	4519512	4X16 B TAPPING SCREW STEEL (C2176PX, C2173MS, C2172MS)		ZP402	0544510	TERMINAL PIECE
	#0184	4519512	4X16 B TAPPING SCREW STEEL (C2178FS)		E001	EY00781	ANT ADAPTOR
	#0186	4519511	4X12 B TAPPING SCREW STEEL		E003	2941311	MANGAN DRY BATTERY EVEREDY
	#0190	3876121	FBT SUPPORT CMT2195 PA		E004	EP00001	SIEMENS ADAPTOR (C2178FS-191/ L/2, C2176PX-981, C2173MS-191/L/2, C2172MS-191/L/2)
					N001	NQR0011	OPERATION GUIDE C2178FS/76PX/ 73MS/72MS
					U1001	HL00861	REMOCON HAND SET CLE-924 (C2178FS, C2173MS)
					U1001	HL00862	REMOCON HAND SET CLE-924A (C2176PX C2172MS)
					U2001	255A762	MICROPHONE AG-35 (C2178FS)



# HITACHI

HITACHI LTD. TOKYO JAPAN  
International Sales Division,  
THE HITACHI ATAGO BLDG.  
No. 15 -12 Nishi-Shinbashi, 2 - Chome,  
Minato-Ku, Tokyo 105, Japan  
Tel. Tokyo 3 32581111

**HITACHI SALES EUROPA GmbH**  
Am Seestern 18,  
40547 Düsseldorf,  
Germany  
Tel. 0211 5291 50

**HITACHI SALES (HELLAS) S.A.**  
91, Falirou Street, 117-41 Athens,  
Greece  
Tel. 92 42-620-4

**HITACHI HOME ELECTRONICS (EUROPE) Ltd.**  
Hitachi House, Station Road, Hayes,  
Middlesex UB3 4DR,  
England  
Tel. 0181 849 2000

**HITACHI SALES IBERICA, S.A.**  
Gran Via Carlos Tercero.101,1 -1  
Barcelona 08028  
Tel. 3- 330.86.52

**HITACHI FRANCE (RADIO-T.V.-ELECTRO-MENAGER) S.A.**  
4, allée des Sorbiers,  
Parc d'active de Chêne,  
69671 BRON Cedex,  
France  
Tel. 72 14-29-70

**HITACHI HOME ELECTRONICS NORDIC**  
Domnarvsgatan 29 Lunda, Box 62  
S-163 91 Spanga,  
Sweden  
Tel. 08 621 8250

**Scan & PDF-Design: Schaltungsdienst  
Lange oHG  
Verlag technische Druckschriften**

**Zehrendorfer Straße 11  
D-12277 Berlin**

**<http://www.schaltungsdienst.com>**