

HITACHI

SERVICE MANUAL

PAL/SECAM/NTSC



HITA-02913

N

No. 02002

CMT2097 - 981R

CMT2077 - 191

- 192

- 192R

CPT2090 - 751

S2 Chassis

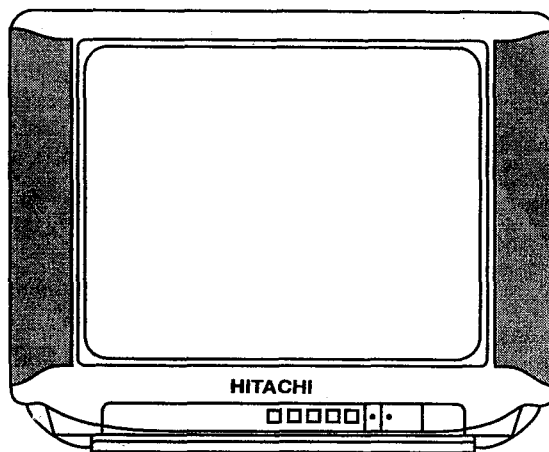

CAUTION: Before servicing this chassis, it is important that the service technician reads the "Safety Precaution" and "Product Safety Notices" in this Service Manual.

CONTENTS

SAFETY PRECAUTIONS.....	2	VERTICAL AMPLITUDE ADJUSTMENT.....	9
PRODUCT SAFETY NOTICE.....	2	ADJUSTMENT POINT.....	9
SPECIFICATIONS.....	3	TROUBLE SHOOTING.....	10
CONTROLS.....	4	WIRING DIAGRAM.....	12
REMOTE CONTROL UNIT.....	4	WAVEFORMS.....	13
CIRCUIT DESCRIPTION.....	5	BASIC CIRCUIT DIAGRAM.....	14
AGC ADJUSTMENT.....	8	PRINTED WIRING BOARD.....	16
HORIZONTAL CENTER POSITION ADJUSTMENT.....	8	REPLACEMENT PARTS LIST.....	17

SPECIFICATIONS AND PARTS ARE SUBJECT TO CHANGE FOR IMPROVEMENT.

COLOR TELEVISION

February 1997 PT. HITACHI CONSUMER PRODUCTS INDONESIA

SAFETY PRECAUTIONS

WARNING : The following precautions should be observed.

1. Do not install, remove, or handle the picture tube in any manner unless shatter proof goggles are worn. People not so equipped should be kept away while picture tubes are handled. Keep the picture tube away from the body while handling.
2. When service is required, an isolation transformer should be inserted between power line and the receiver before any service is performed on the chassis.
3. When replacing the chassis in the cabinet, ensure all the protective devices are put back in place, such as barriers, non-metallic knobs, adjustment or compartment covers or shields, isolation resistors/capacitors, etc.
4. When service is required, observe the original lead dressing. Extra precaution should be taken to assure correct lead dressing in the high voltage circuitry area. particularly note the R. G. B. lead dressing. Ensure they are dressed well away from the horizontal scan and F. B. T. circuitry.
5. Always use the manufacturer's replacement component. Always replace original spacers and maintain lead lengths. Especially critical components are indicated thus \triangle on the parts list and should not be replaced by other makes. Furthermore, where a short circuit has occurred, replace those components that indicate evidence of overheating.
6. Before returning a serviced receiver to the customer, the service technician must thoroughly test the unit to be certain that it is completely safe to operate without danger of electrical shock, and be sure that no protective device built into the instrument by the manufacturer has become defective, or inadvertently damaged during servicing. Therefore, the following checks are recommended for the continued protection of the customers and service technicians.

INSULATION

Insulation resistance should not be less than 10M Ω at 500V DC between the mains poles and any accessible metal parts. Also, no flashover or breakdown should occur during the dielectric strength test, applying 3kV AC or 4.25kV DC for two seconds between the main poles and accessible metal parts.

HIGH VOLTAGE

High voltage should always be kept at the rated value of the chassis and no higher. Operating at higher voltages may cause a failure of the picture tube or high voltage supply, and also, under certain circumstances could produce X-radiation moderately in excess of design levels. The high voltage must not, under any circumstances, exceed 28kV on the chassis.

X-RADIATION

TUBES: The primary source of X-radiation in this receiver is the picture tube. The tube utilised for the above mentioned function in this chassis is specially constructed to limit X-radiation.

For continued X-radiation protection, replace tube with the same type as the original HITACHI approved type.

PRODUCT SAFETY NOTICE

Many electrical and mechanical parts in HITACHI television receivers have special safety related characteristics. These characteristics are often not evident from visual inspection, nor can the protection afforded by them necessarily be obtained by using replacement components rated for higher voltage, wattage, etc. Replacement parts which have these special safety characteristics are identified by marking with a \triangle on the schematics and replacement parts list in this Service Manual. The use of a substitute replacement component which does not have the same safety characteristics as the HITACHI recommended replacement one, shown in the parts list in this Service Manual, may create electrical shock, fire, X-radiation, or other hazards.

Product Safety is continuously under review, and new instructions are issued from time to time. For the latest information, always consult the current HITACHI Service Manual. A subscription to, or additional copies of HITACHI Service Manuals, may be obtained at a nominal charge from your HITACHI SALES CORPORATION.

TUBE DISCHARGE

The line output stage can develop voltages in excess of 25kV; if the E. H. T. cap is required to be removed, discharge the anode cap to chassis via a high value resistor, prior to its removal from the tube.

Specifications (CMT 2097)

Reception system	625-lines : B. G/I/D. K/H PAL B. G/D. K/K' SECAM NTSC50 525-lines M/NTSC NTSC3. 58-5 5/6. 0/6.5 NTSC4 43-5 5/6 0/6.5 PAL60	Aerial input	75 Ω unbalanced type
		Color picture tube	A48QAD220X
		Speaker	15 cm X 6.5 CM (X 2)
		Sound output (Max)	5 W X 2
		Power supply	AC 110/127/220/230V, 50/60Hz
Channel coverage (Frequency range) 45MHz~294MHz 470MHz~863MHz	CCIR : E2~12, E21~69, S01~3, S1~10, S11~20 OIRT : R1~12, R21~69 JAPAN : J1~12, J13~62 U S A : US2~13, J~W, US14~69 Hong Kong, U K UK21~69 China : C1~12, C13~57	Power consumption	89W
		Weight (kg)	21.0
		Dimensions W X H X D (cm)	61.0 X 46.0 X 47.0

★ Specifications are subject to change without notice to improve performance.

Specifications (CMT 2077)

Reception system	625-lines : B. G/I/D. K/H PAL B. G/D K/K' SECAM 525-lines : NTSC50 NTSC3. 58-5. 5/6. 0/6.5 NTSC4. 43-5. 5/6. 0/6.5 PAL60	Aerial input	75 Ω unbalanced type
		Color picture tube	A48QAD220X
		Speaker	15 cm X 6.5 CM (X 2)
		Sound output (Max)	5 W X 2
		Power supply	AC 110/127/220/230V, 50/60Hz
Channel coverage (Frequency range) 45MHz~294MHz 470MHz~863MHz	CCIR : E2~12, E21~69, S01~3, S1~10, S11~20 OIRT : R1~12, R21~69 Hong Kong, U. K. : UK21~69 China : C1~12, C13~57	Power consumption	89W
		Weight (kg)	21.0
		Dimensions W X H X D (cm)	61.0 X 46.0 X 47.0

★ Specifications are subject to change without notice to improve performance.

Specifications (CPT 2090)

Reception system	625-lines : B. G PAL NTSC50-(VIDEO) 525-lines : NTSC3 58-(VIDEO) NTSC4. 43 PAL60	Aerial input	75 Ω unbalanced type
		Color picture tube	A48QAD220X (S)
		Speaker	15 cm X 6.5 CM (X 2)
		Sound output (Max)	5 W X 2
		Power supply	AC 240V, 50Hz
Channel coverage (Frequency range) 45MHz~294MHz 470MHz~863MHz	Australia : AU 0~12 AU 28~69	Power consumption	89W
		Weight (kg)	21.0
		Dimensions W X H X D (cm)	61.0 X 46.0 X 47.0

★ Specifications are subject to change without notice to improve performance

CONTROLS

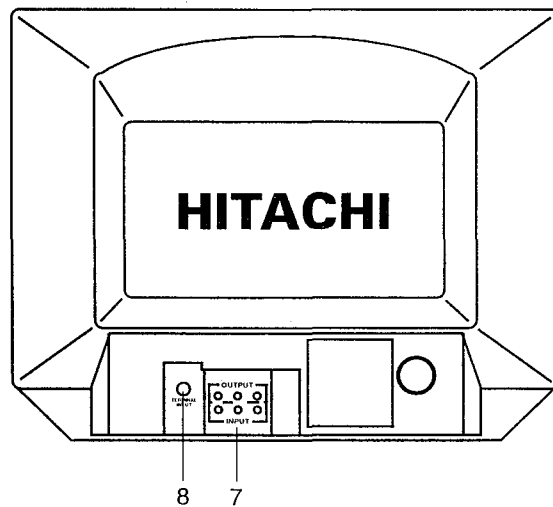
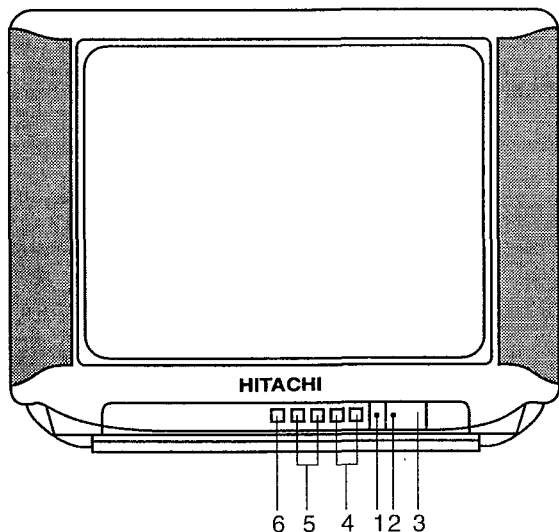

- | | | | |
|----------------------------|-------------------------------|-----------------------|--------------------------|
| 1. POWER switch | 3. Power indicator (Stand-by) | 5. Volume up/down | 7. AV in/out terminals |
| 2. Remote control receiver | 4. Programme up/down | 6. TV/VIDEO selection | 8. Aerial input terminal |

REMOTE CONTROL UNIT

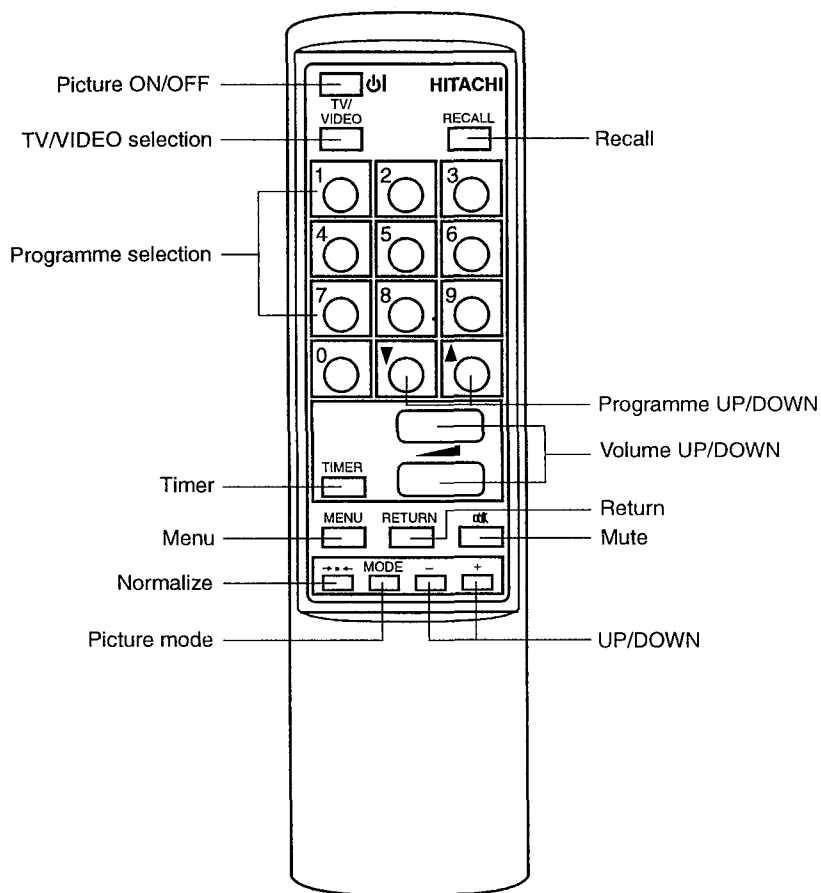

CIRCUIT DESCRIPTION

Tuner and I.F. Stages :

The tuner used on this chassis, is powered by the +9V, supply, and covers VHF, UHF and CABLE

The I.F. output from the tuner is applied to amplifier Q201 then selected with the mode shown in Table 1 and input to CP201 or CP202 (CMT 2097 ONLY)

Sound I.F. Stages : (CMT 2097/2077)

The sound stages consist of IC201, which is basically a demodulator, and IC402, which is the audio control and IC4501, which is the output amplifier

The I.F. signal at the collector of Q201, is fed via filter CP201, and input to IC201 at pins 45 and 46.

The composite signal output from pin 7 of IC201 is input to sound filters MF401^{*1}, MF402, MF403 and MF404, and selected with the mode shown in Table 1 at IC451 after being output from the filter. The selected signal is then input to pin 5 of IC201 via C422. Demodulation is then performed by the IC, with the sound output being obtained from pin 1. This sound signal is controlled by IC402. It is then input to pins 2,5 of IC4501 via C408, C409 for further amplification, and output to the speaker from pins 7,12. Volume control is performed by the DC voltage applied to pin 5 of IC201. This is obtained via R427 from pin 8 of IC1101. Sound demodulation output at pin 1 of IC201, is applied to the terminal of rear via Q401 (CMT 2077) or Q 4502 at sound sub PWB (CMT 2097)

From the output terminal, the audio signal can be output to external equipment if desired. Audio signals from external equipment can be applied to the input terminal of rear. They are then input to IC201 at pin 6. When connecting audio signals this way, a "High" is applied to pins 16 of IC201 from IC1101, thereby changing the internal switching circuitry of the IC. The audio input applied to pin 6 of IC201. Volume control of the external audio signal is then obtained in the same way as internal sound i.f. by the voltage at pin 5 of IC201.

B G/D K	M/I	Saw filter	Sound filter	Sound trap
H	H	CP202	MF401(4.5MHz)	MF 503
L	H	CP201	MF402(5.5MHz)	MF 501/ MF502
H	L		MF403(6.0MHz)	
L	L		MF404(6.5MHz)	

Table 1.

Sound I.F. Stages : (CPT 2090)

The sound stages consist of IC201, which is basically a demodulator, and IC4501, which is the output amplifier

The I.F. signal at the collector of Q201, is fed via filter CP201, and input to IC201 at pins 45 and 46.

The composite signal output from pin 7 of IC201 is input to sound filter, MF401, and sound I.F. signal is then input to pin 5 of IC201 via C422. Demodulation is then performed by the IC, with the sound output being obtained from pin 1. It is then input to pins 2,5 of IC4501 via C408, C409, for further amplification, and output to the speaker from pins 7, 12

Volume control is performed by the DC voltage applied to pin 5 of IC201. This is obtained via R427 from pin 8 of IC1101. Sound demodulation output at pin 1 of IC201, is applied to the terminal of rear via Q401. From the output terminal, the audio signal can be output to external equipment if desired

Audio signals from external equipment can be applied to the input terminal of rear. They are then input to IC201 at pin 6. When connecting audio signals this way a "signal" is applied to pin 16 of IC201 from IC1101, thereby changing the internal switching circuitry of the IC.

^{*1} ONLY FOR CMT 2097

Volume control of the external audio signal is then obtained in the same way as internal sound i.f. by the voltage at pin 5 of IC201.

Vision I.F. Stages :

The I.F. Signal from CP201 and CP202 is input to pins 45 and 46 of IC201. These pins supply an internal amplifier consisting of three stages whose gain is controlled by the AGC circuit. The response speed of this internal AGC stage is determined by the external components connected to pin 48

The output from the I.F. amplifier is then fed to the video detector circuitry. The picture carrier is limited and phase shifted by the tank circuitry of L202 etc, connected between pins 2 and 3 of the IC. This produces a reference frequency which is utilised for synchronous video detection

An RF AGC voltage is made available at pin 48 of IC201, the starting level of which is determined by the voltage applied to pin 49, which in turn is fixed by the setting of VR202. This AGC voltage is then fed to the tuner via R208 to control its gain accordingly.

The composite video finally emerges at pin 7 of IC201

Luminance Circuitry : (CMT 2097/2077)

The composite video signal output from pin 7 of IC201 is applied to the sound rejection filter MF501, MF502, and MF503^{*1}. MF501, MF502 and MF503^{*1} are selected with the mode shown in Table 1. The resulting luminance signal is applied to the terminal of rear, for output to external equipment if desired. It is then returned to pin 13 of IC201 via Q506, for colour decoding and deflection synchronisation

The luminance signal is added internally to the R G B. matrix circuits of IC201, as well as being controlled by the brightness, contrast, and blanking stages of the IC.

The luminance signal finally emerges with the R G B. signals from pins 18, 19 and 20 of IC201

The voltages to control the contrast and brightness levels are output from pins 3 and 4 of IC1101, then applied to pins 17 and 25 of IC201

An automatic beam current circuit is employed on this chassis. Should the beam current start to rise, the voltage at pin 4 of the flyback transformer will fall. This fall is applied to the cathode of D758, then via R760 to pin 25 of IC201, thereby reducing the contrast level and hence the beam current

Video inputs from external equipment connected to the terminal of rear, are fed to IC201 pin 15 via Q510

When the external mode is selected, a "High" is applied to pin 16 of IC201

Luminance Circuitry : (CPT 2090)

The composite video signal output from pin 7 of IC201 is applied to the sound rejection filter MF503

The resulting luminance signal is applied to the terminal of rear, for output to external equipment if desired

It is then returned to pin 13 of IC201 via Q506, for color decoding and deflection synchronisation

The luminance signal is added internally to the R G B. matrix circuits of IC201, as well as being controlled by the brightness, contrast, and blanking stages of the IC.

The luminance signal finally emerges with the R G B. signals from pins 18, 19 and 20 of IC201.

The voltages to control the contrast and brightness levels are output from pins 3 and 4 of IC1101, then applied to pins 17 and 25 of IC201

An automatic beam current circuit is employed on this chassis. Should the beam current start to rise, the voltage at pin 4 of the flyback transformer will fall. This fall is applied to the cathode of D758, then via R760 to pin 25 of IC201, thereby reducing the contrast level and hence the beam current.

Video inputs from external equipment connected to the terminal of rear, are fed to IC201 pin 15.

When the external mode is selected, a "High" is applied to pin 16 of IC201.

Chrominance Circuitry : (CMT 2097/2077)

IC201 is designed to demodulate PAL, NTSC and SECAM systems. And this IC can distinguish between PAL, NTSC or SECAM signals. The demodulated colour signals are output from IC201 pins 30 and 31 as the R-y and B-y signals, then fed to pins 14 and 16 of IC501 which is a switch capacitor delay line.

IC201 allows bi-directional communication between the SECAM decoder IC502 and automatic system manager for SECAM identification. It delivers the VCXO (voltage controlled xtal oscillator) reference frequency (4.43MHz only) to the SECAM decoder via pin 32 of IC201. Once SECAM is identified, the gated reference signal is outputted to pin 32 of IC201.

The inputs at pins 14 and 16 are clamped, then fed via a buffer stage to internal delay lines, which are driven by a clock signal of 3MHz to obtain a delay period of 640 Seconds. This internal clock is generated from a 6MHz voltage controlled oscillator, and line locked by the sandcastle pulse input at pin 5. Low pass filters after the delay line stages suppress the clock signals.

The undelayed and the delayed signals are then added, with the resulting R-y and B-y signals being output from pins 11 and 12 via an internal buffer stage.

These outputs are then fed to IC201 at pins 28 and 29.

This IC contains clamping circuits, and a DC colour saturation control, the level of which is set by the voltage applied to pin 26 from pin 5 of IC1101. The signals are then applied to a MATRIX circuit, and finally emerge from pins 18, 19 and 20 as the blue, green, and red signals.

Chrominance Circuitry : (CPT 2090)

IC201 is designed to demodulate PAL and NTSC systems. And this IC can distinguish between PAL or NTSC signals. The demodulated color signals are output from IC201 pins 30 and 31 as the R-y and B-y signals, then fed to pins 14 and 16 of IC501 which is a switch capacitor delay line.

The inputs at pins 14 and 16 of IC501 are clamped, then fed via a buffer stage to internal delay lines, which are driven by a clock signal of 3MHz to obtain a delay period of 640 Seconds. This internal clock is generated from a 6MHz voltage controlled oscillator, and line locked by the sandcastle pulse input at pin 5. Low pass filters after the delay line stages suppress the clock signals.

The undelayed and the delayed signals are then added, with the resulting R-y and B-y signals being output from pins 11 and 12 of IC501 via an internal buffer stage.

These outputs are then fed to IC201 at pins 28 and 29.

This IC contains clamping circuits, and a DC colour saturation control, the level of which is set by the voltage applied to pin 26 from pin 5 of IC1101. The signals are then applied to a MATRIX circuit, and finally emerge from pins 18, 19 and 20 as the blue, green, and red signals.

Deflection Circuits :

The deflection circuitry of IC201 contains a sync, separator stage, horizontal oscillator and output stages, a vertical count-down and output stage

Horizontal Stage :

The composite video signal from pin 7 of IC201 is returned to pin 13 via C302 as explained previously. This input is applied to the internal sync separator stages of the IC

A internal phase detector stage is provided with a sawtooth waveform, generated from the line pulse input to pin 38. The phase detector will then compare this sawtooth waveform to the sync. pulse. Any frequency drift will cause a corrective output to be applied to the horizontal oscillator, thereby maintaining the desired phase relationship.

The components connected to pin 40 form a filter network for the phase detector, and VR701/connected to pin 39 provides manual phase control. The horizontal output emerges at pin 37 and is then applied to the base of line drive transistor Q721. T721 couples the output of Q721 to the line output transistor Q781. Both these transistors are powered by the 95V supply. A line pulse available at pin 6 of the flyback transformer is rectified by D751, smoothed by C756 and provides approximately 180V to drive the output transistors Q851, Q852, Q853.

Under certain fault conditions, i. e. increased H. T. supply, low line oscillator frequency, or reduced value of the tuning capacitor C781, an excess of E. H. T. could be developed. To prevent this happening, the rectified voltage of D751 is fed via potential divider R757, R758, and applied to ZD751. Should the E. H. T. rise excessively, the threshold of the zener will be exceeded, and a voltage will be applied to pin 35 of IC1101 via R1106, thereby shutting down the power circuit.

This effectively applies a "Low" to Q903 base, turning the transistor off. Consequently, Q902 will be turned off, and the +8V supply to IC201 is then removed, thereby shutting down the deflection stages of the IC, preventing further E. H. T. generation.

Excessive beam current can also occur under certain fault conditions, so this is prevented in the following manner. The H. T. current to the horizontal output stages is measured by R781.

Should the current rise, the voltage drop across R781 will increase, and a voltage will be applied to the gate of Q901. This will then prevent further E. H. T. generation as described earlier.

A supply of +25V is required for IC681. This is obtained from pin 1 of the flyback transformer, and smoothed by C754.

Vertical Stages :

The internal vertical sync. of IC201 is fed to a triggered vertical divider stage, which counts down the horizontal frequency to obtain the vertical frequency, thereby eliminating the need for a conventional oscillator circuit.

This also has the advantage that no external frequency control is required.

C601 at pin 42 of the IC is used for ramp generation, and produces the required sawtooth output.

The vertical output from pin 43 of IC201 is applied to pin 4 of IC681 via R604. The components D601 and C605 determine the flyback generation time, and the vertical output to drive the deflection coils is made available from pin 2.

The deflection current that occurs at the junction of R609, is added to the feedback from R607/C608 etc. and the result is applied to pin 41 of IC201. The values of R607 and C608 determine the linearity, whilst VR601 sets the vertical height

Power Supply Circuit :

AC input is rectified by D901–04 and produces approximately 300V to pin 3 of IC901.

Current flowing through R902–03, C905, causes power transistor in IC901 to initially turn on.

Secondary voltages are then induced in T901, and a feedback voltage is obtained via C910, R905 etc. and applied to pin 2 of IC901, thereby maintaining the transistors operation.

Secondary voltage in F1. F2 winding is rectified by D905 to produce H. T. of 95V which is smoothed by C914

S1 S2 winding produces 14V from D908, and this is smoothed by C916.

Pin 5 of IC901 is set to a pre-determined level by resistor network in IC901. Should the H. T. rise, pin 5 voltage of IC901 will become more positive, and this difference is amplified by transistor in IC901. An output is applied to drive transistor, and controls on time of power transistor. In this way, the H.T. is regulated and maintained at a constant level. D909 offers protection to the H.T. circuits should the voltage level rise excessively.

When the standby mode is selected, pins 21 and 22 of IC1101 will go "Low" removing the drive to Q903. As a result, Q902 is turned off, and voltage to pin 36 of IC201 disappears, therefore shutting down the deflection stages of the IC. E.H.T. generation will then cease for as long as the standby condition exists.

Remote Control and Tuning Circuitry :

The remote control receiving unit CP1201, contains an infrared amplifier type SPS409. This is powered by the +5V supply, which is stabilized by ZD1101. The output from pin 2 of this unit is applied to pin 16 of IC1101.

This IC type M37210M4, performs channel selection, UP/DOWN analogue control, and screen display, search tuning, and controls inputs and search tuning, and controls inputs and outputs to and from the AV terminal.

IC1102 is the memory IC, which stores the data relating to the above functions, then transfers that information to IC1101 when required. Both these ICs are powered by the +5V supply.

X1101 supplies IC1101 with a basic clock frequency which controls all operating mode requirements.

When the TV is first switched on, IC1101 must be initially reset, and this is achieved by IC1101 stage. As the +5V supply begins to rise from switch on, pin 3 of Q1105 is held "Low" This is applied to pin 30 of IC1101 thus resetting the IC. Once pin 1 of Q1105 has almost reached its +5V potential, the "Low" is removed from pin 3 thus releasing the reset condition.

When the search routine has been initiated and a signal has been located, pin 14 of IC201 will become "High". This is applied to pin 34 of IC1101, and informs the IC that a signal is present. The search routine then stops, and the IC will monitor the AFC signal present at pin 15 to obtain the optimum signal.

Pins 46 and 47 control the signal system.

Contrast, colour, brightness, sharpness, tint, and volume are all controlled from the remote control handset (the volume can also be adjusted by + and – buttons on the front of the TV), and will produce DC level changes from pins 3–8 of IC1101, which are then fed to the relevant pins of IC201.

Pins 31–32, 37–39, and 11 form the in and out matrix for the front control operations.

Pins 12 and 13 are the clock and data output pins These signals are supplied to the memory IC1102.

It is supplied to pin 16 of IC201. When "High", the IC will process external inputs applied to pins 13 and 15, and when "Low", the internal signals are processed.

The handset button marked TV/VIDEO will need to be pressed This will then produce the required "High" from pin 20 to achieve the necessary switching, as explained earlier.

The red, green and blue on-screen display signals are output from pins 50, 51 and 52. The components L1102, C1102, and C1103, on pins 28 and 29, determine the display oscillator frequency. The horizontal and vertical inputs at pins 1 and 2 determine the actual position of the on screen display

When a command requiring an on-screen display is received by IC1101, a "High" will be output from pin 49.

This is applied to pin 21 of IC201, and blanks out a portion of the picture. The on-screen display information is then inserted into this portion, thus resulting in a clear display When the ALARM mode has been set, and the time input has elapsed, an output is obtained from pin 45 of IC1101.

This is then applied via R1184, R1119, C1111, R1118 etc. to pins 2 and 5 of IC4501 thus causing a "Bleep" sound to be heard.

Once the "OFF" timer mode has been set, and the time input has elapsed, pins 21 and 22 of IC1101 output a "Low".

This removes the supply to the base of Q903, and as a result the +9V output of Q902 disappears This places the TV into its standby mode of operation by removing E. H. T generation as explained previously.

When the "ON" time has been estimated and set, the standby command must be transmitted by the handset, to place the TV into its standby mode. As an indication that the standby mode is only temporary, pin 20 of IC1101 is taken "High" and "Low" alternately, causing D1114 to flash on and off.

When the entered time has elapsed, the "Low" outputs from pins 21 and 22 of IC1101 are removed, and the TV will return to normal operation.

AGC ADJUSTMENT

ADJUSTMENT LOCATION VR202

Preparations for adjustment	Adjustment Procedure	Remarks
<p>1 With the signal received, apply heat run for more than two minutes to avoid the influence of circuit temperature drift.</p> <p>2 Connect the voltmeter of at least 100kΩ internal impedance to the AGC terminal of the tuner.</p>	<p>1 Received following channel and strength.</p> <p>CHANNEL : CCIR 5 STRENGTH : -47 dBm</p> <p>Adjust VR202 until the following voltage is reached. V1-(0.5±0.2v) 2 V1:the voltage without signal</p>	

HORIZONTAL CENTER POSITION ADJUSTMENT

ADJUSTMENT LOCATION VR701

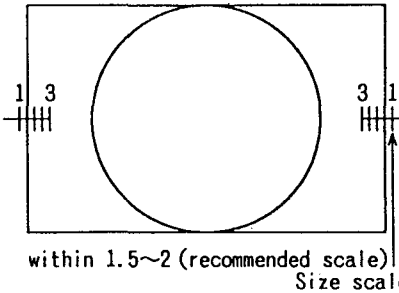
Preparations for adjustment	Adjustment Procedure	Remarks
<p>1 Receive the circle pattern signal.</p> <p>2 Set the brightness and contrast VRs to maximum.</p>	<p>1 Turn VR701 (H.Phase) and adjust so that size scales on the left and right are equal. (Refer to Fig. 3-2-1.)</p> <div style="text-align: center;">  <p style="text-align: center;">within 1.5~2 (recommended scale) Size scale</p> <p style="text-align: center;">Fig. 3-2-1</p> </div>	<p><u>Picture information amount</u> The amount of information means the amount of the transmitted picture that can be displayed on the CPT screen. It is necessary to increase this amount of information as much as possible and also decrease the lack of raster as far as possible.</p>

VERTICAL AMPLITUDE ADJUSTMENT

ADJUSTMENT LOCATION VR601

Preparations for adjustment		Adjustment Procedure		Remarks
1	Start adjustment 5 minutes or more after the power switch is turned on.	1	Select V.CENT select chip "u", "N" and "D" so that the center of the picture is closest to the geometrical center of the CPT.	
2	Receive the PAL circle pattern signal.	2	Adjust VR601 as shown in Fig. 3-3-1.	
3	Set the brightness and contrast VRs to maximum.	3	Receive the NTSC circle pattern signal and check that the picture is the same as that when a PAL signal is received.	
4	Place the set facing north or south.			

Picture condition		Top shrunk, bottom expanded	Standard condition	Top expanded, bottom shrunk
				
Adjustment method	Picture top	Center of inner and outer circles	Center of inner circle	
	Picture bottom		Inner circle	Center of inner and outer circles

Fig. 3-3-1

ADJUSTMENT POINT

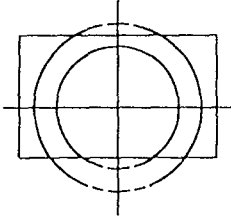
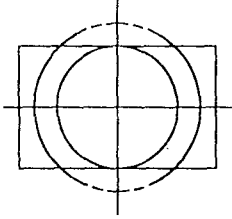
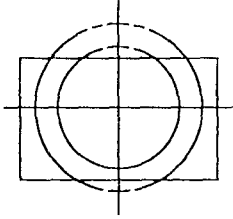
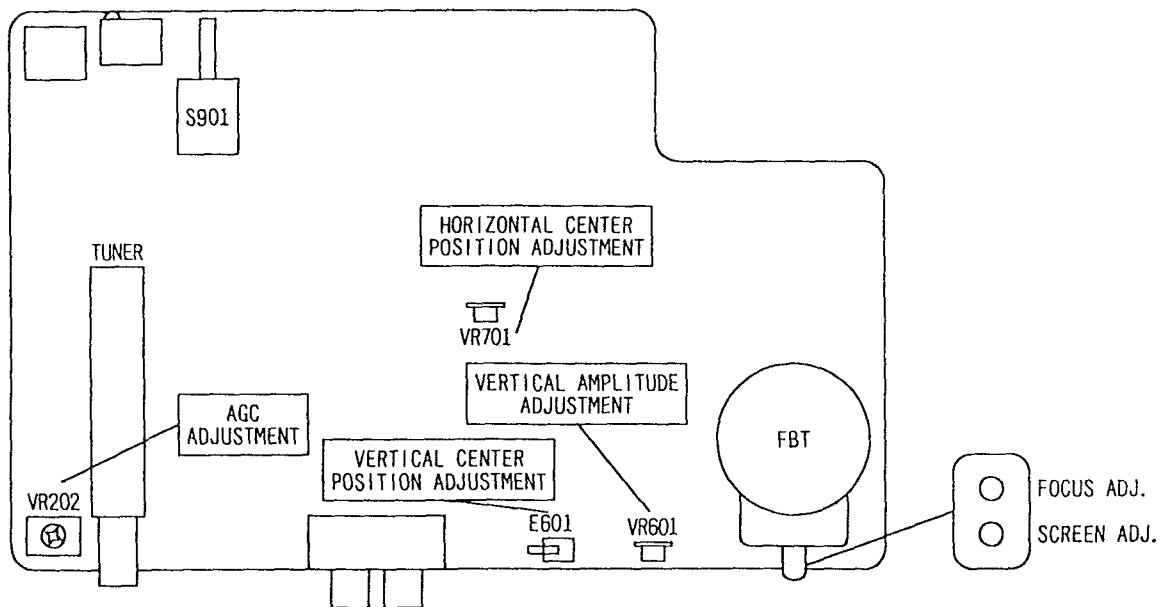

TROUBLE SHOOTING

No +B

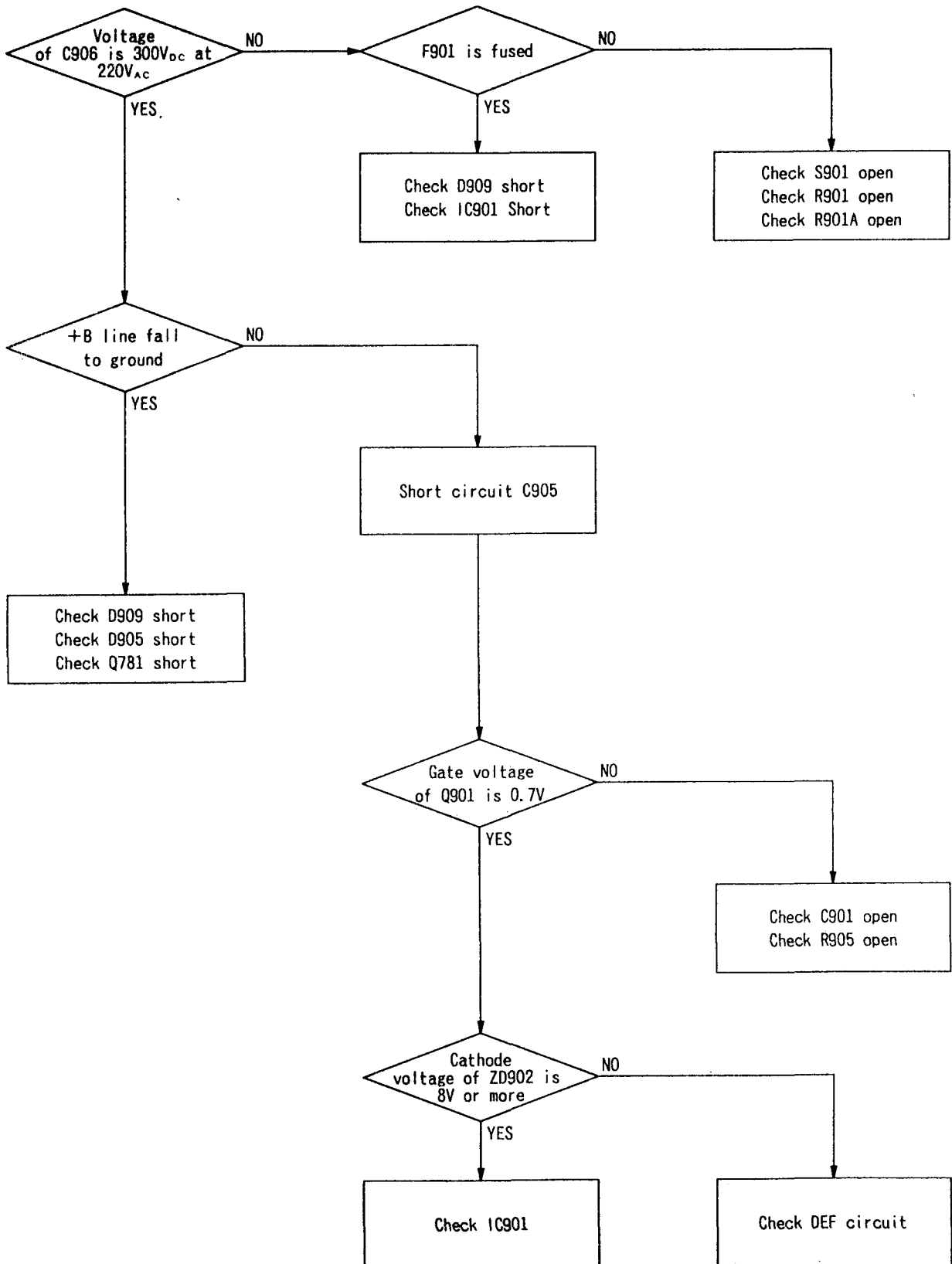

TV SET DOES NOT GO TO ON FROM STAND-BY MODE

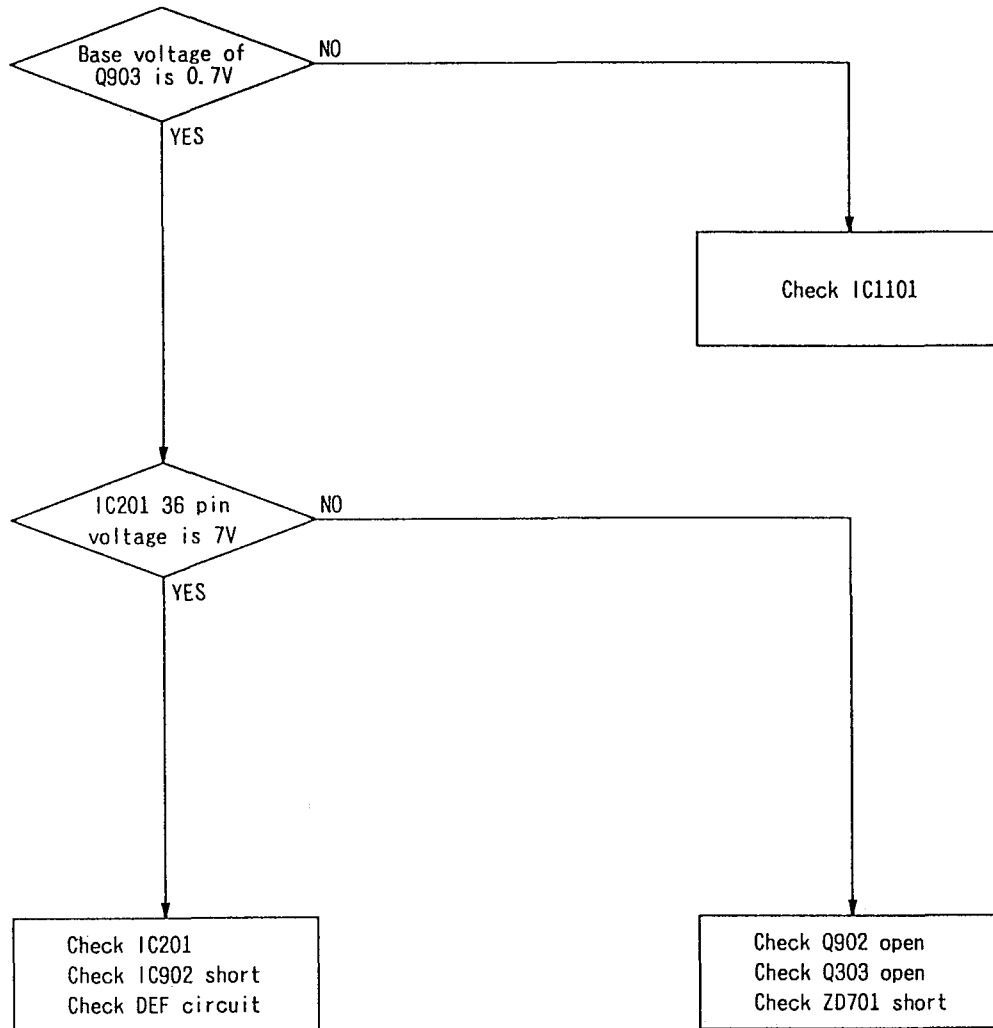

WIRING DIAGRAM

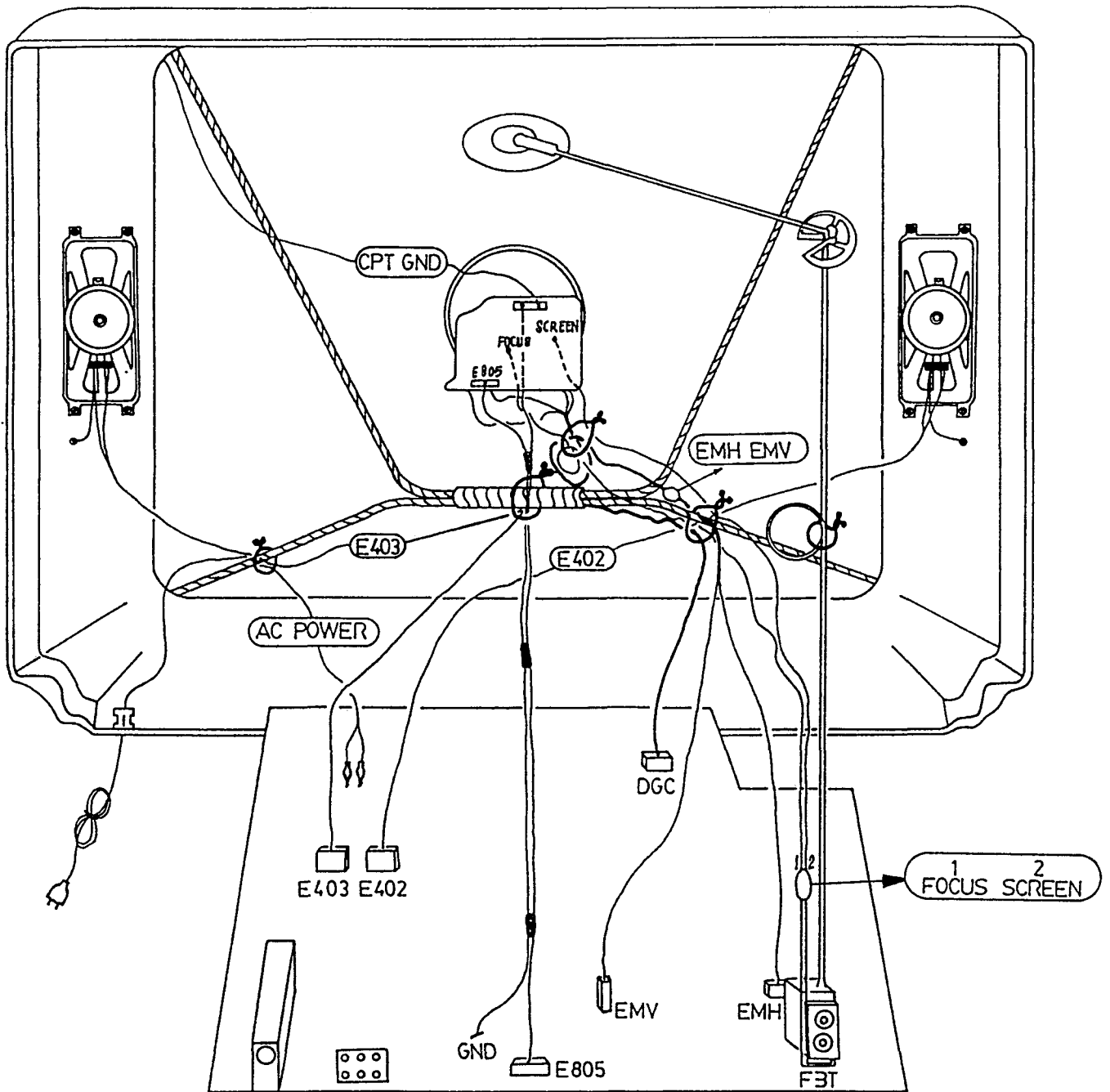

WAVEFORMS

① IC201 ⑦ pin

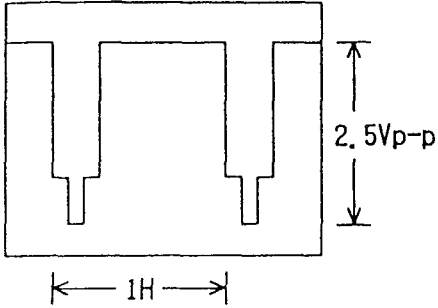

⑤ IC201 ⑳ pin

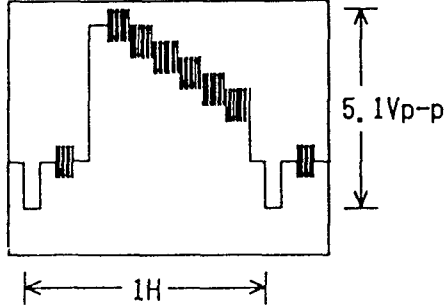

⑨ IC201 ⑳ pin

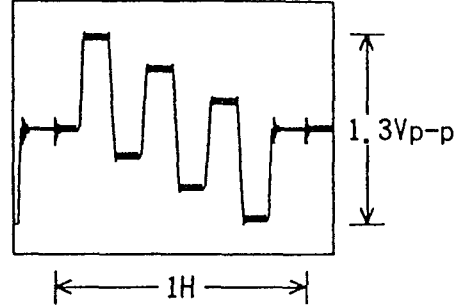

② V-DY

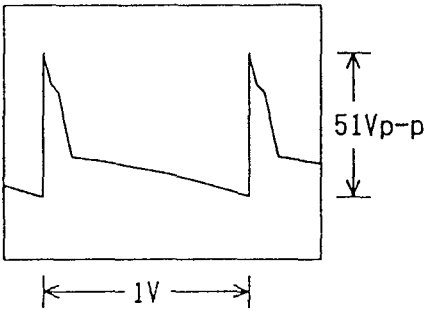

⑥ IC901 ③ pin

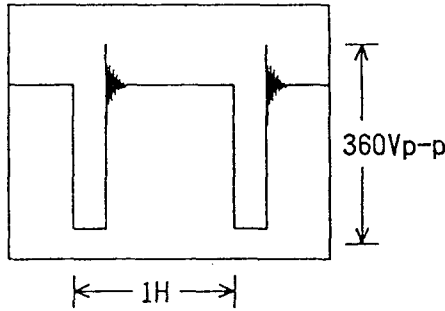

⑩ IC201 ⑳ pin

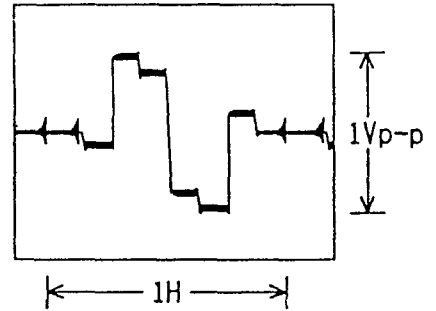

③ IC201 ⑳ pin

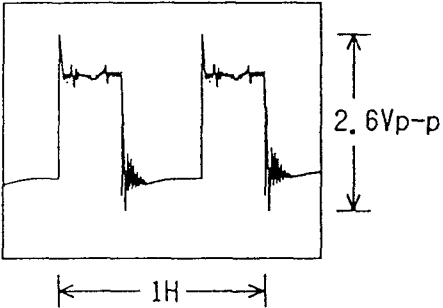

⑦ Q781 Collector

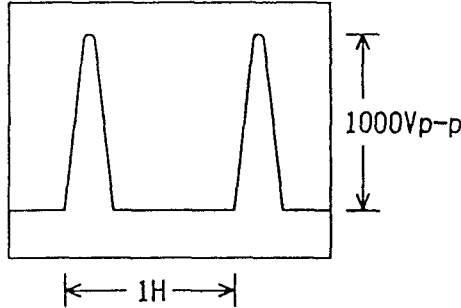

⑪ IC201 ⑳ pin NTSC/PAL

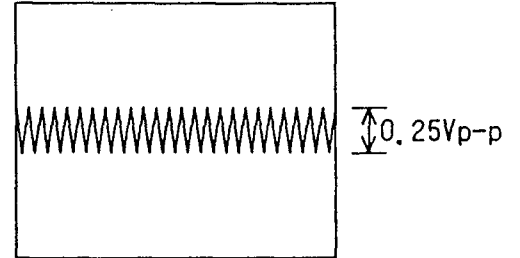

④ IC201 ⑳ pin

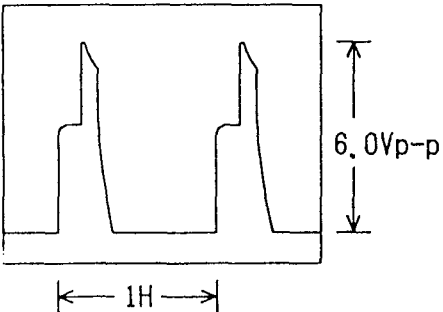

⑧ IC201 ④ pin

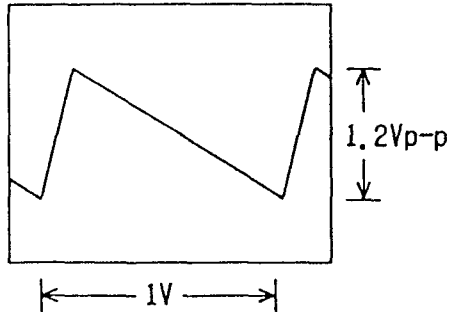

⑫ IC201 ⑳ pin SECAM

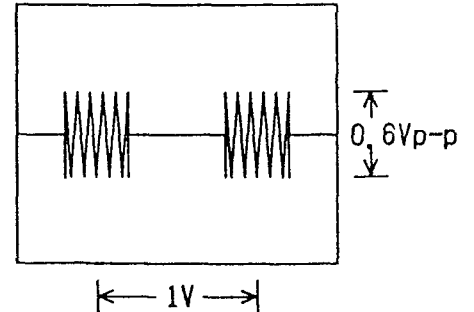

CMT2097 BASIC CIRCUIT DIAGRAM

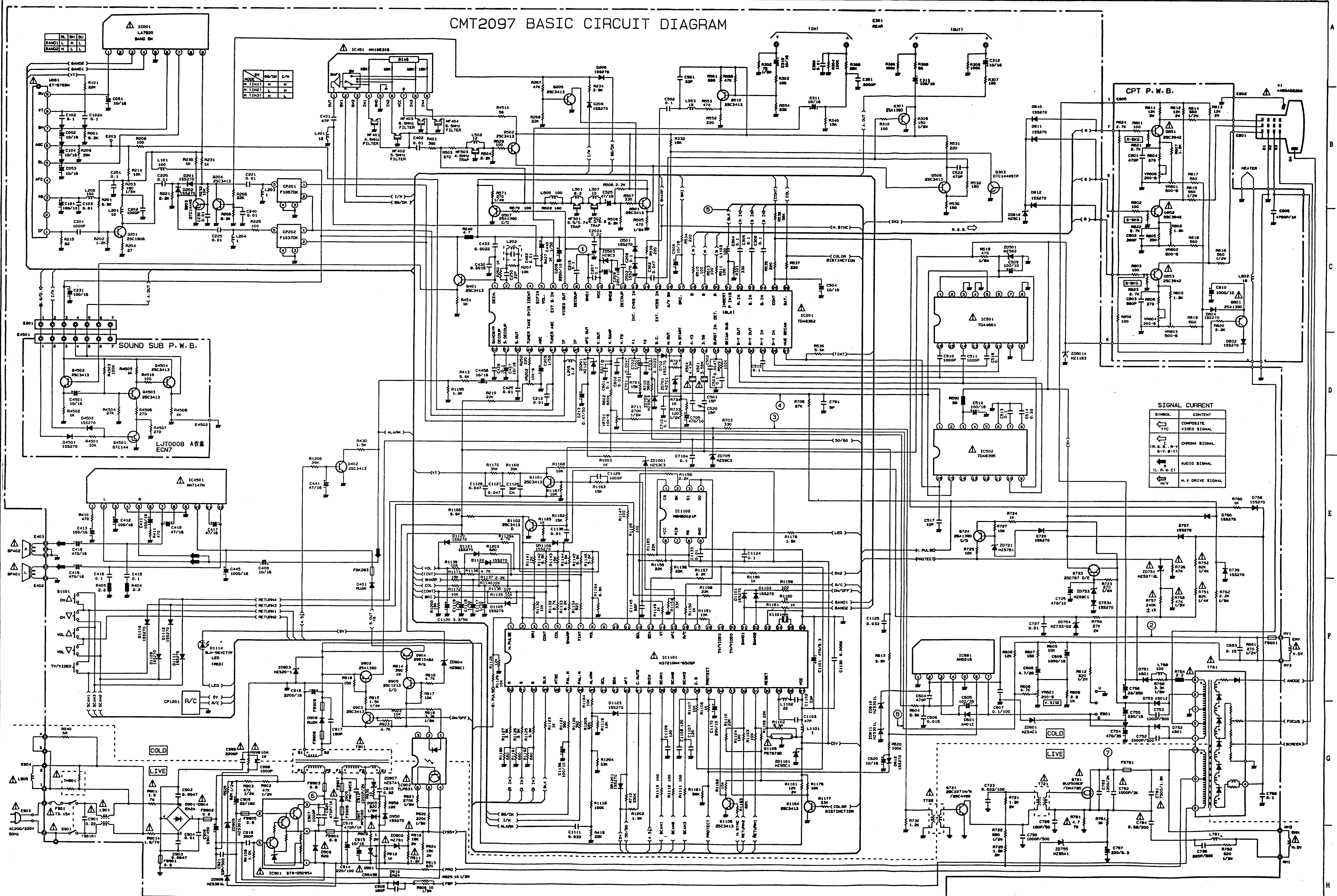

SIGNAL CURRENT

SYMBOL	CONTENT
\leftarrow	COMPOSITE VIDEO SIGNAL
\leftarrow (with R, G, B)	CHROMA SIGNAL
\leftarrow (with I, Q)	AUDIO SIGNAL
\leftarrow (with H, V)	H. V DRIVE SIGNAL

ABCDEFGHIJKLMNPQRSTUVWXYZ

abcdefghijklmnpqrstuvwxy

CMT2077 BASIC CIRCUIT DIAGRAM

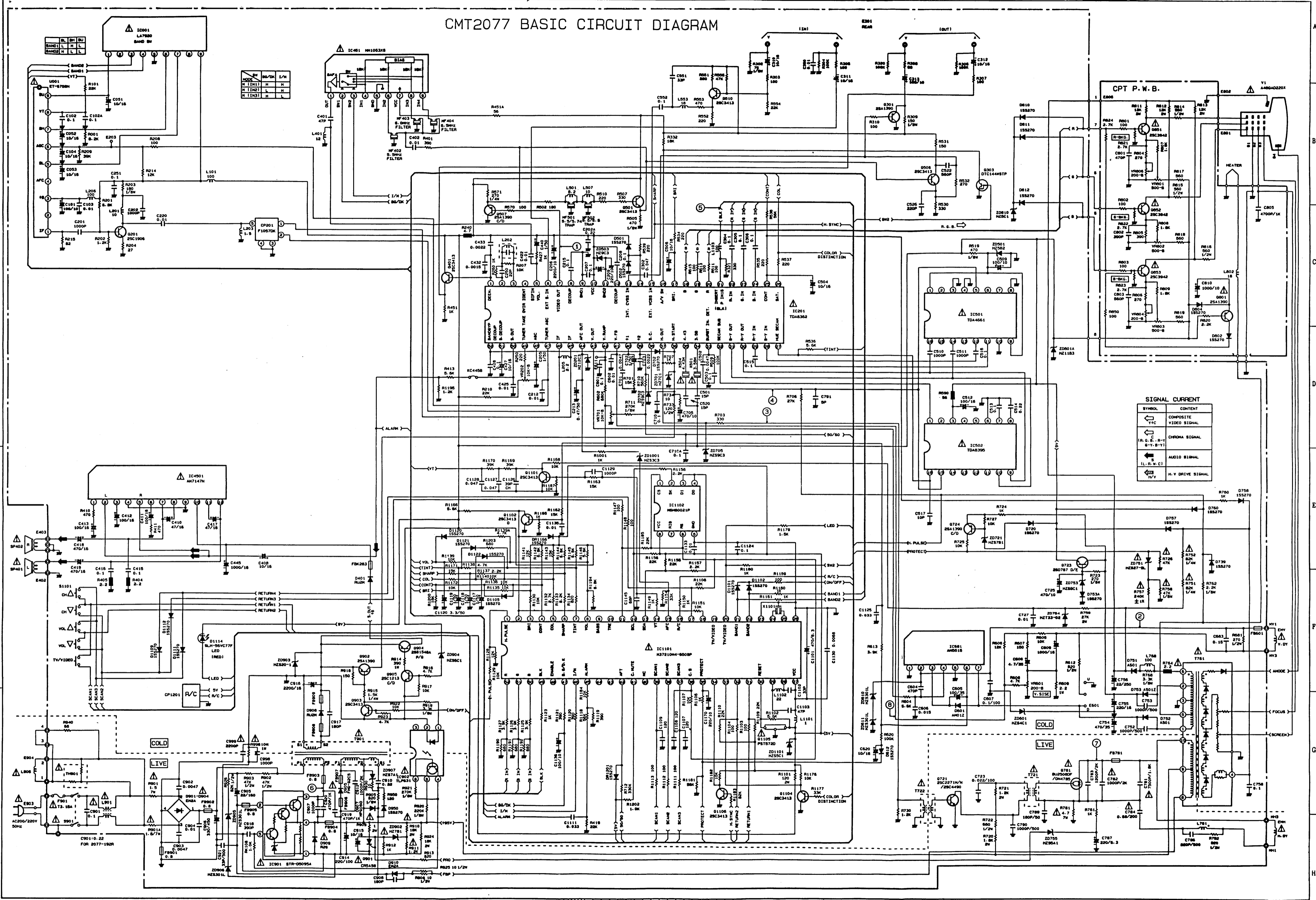

SIGNAL CURRENT

SYMBOL	CONTENT
← Y/C	COMPOSITE VIDEO SIGNAL
← (R-G, B-Y, E-Y, B-Y)	CHROMA SIGNAL
← (L-R, M-C)	AUDIO SIGNAL
← H/V	H-V DRIVE SIGNAL

ABCDEFGHIJKLMNPQRSTUVWXYZ

abcdefghijklmnpqrstuvwxy

PRODUCT SAFETY NOTE : Components marked with a  have special characteristics important to safety. Before replacing any of these components, read carefully the **PRODUCT SAFETY NOTICE** of this Service Manual. Don't degrade the safety of the receiver through improper servicing

SYMBOL NO.	PART NO.	DESCRIPTION
#A	JT06021	CMT2097-981R MAIN PWB ASS'Y
#B	JT06022	CMT2077-191 MAIN PWB ASS'Y
#C	JT06023	CMT2077-192R MAIN PWB ASS'Y
#D	JT06024	CPT2090-751 MAIN PWB ASS'Y
#0102	8821234	NUT-3
#0104	4269926	W A S H E R
#0106	4520883	3*12 SCREW WITH WASHER
#0112	3442421	HEAT SINK
#0114	4519506	3*8 B-TITE SCREW
#0150	3708104	G7 - X4 A LED HOLDER
#0153	3701202	PWB HOLDER G7 - A
#0155	3746073	IEC POWER CORD HOLDER
#0180	ME00111	INSULATOR S2
#0190	ME00121	PVC SHIELD PLATE S2
#0910	MA00031	HEAT SINK FOR IC901
#0912	4520883	3*12 SCREW WITH WASHER
#0914	4333705	HEAT SINK S0 POWER
A11	JT05211	S2 SOUND SUB PWB ASS (CMT 2097)
A11	LJT0521 A	SOUND SUB PWB ASS (CMT 2097)
B001	JK01002	PRINTED WIRING BOARD
CP1201	2574762	R/C MODULE SPS-409-1K
CP201	BG00281	SAW FILTER G1980M (CPT 2090)
CP201	2306121	SAW F1057DK (CMT 2097, CMT 2077)
CP202	2306122	SAW F1037DK (CMT 2097)
C051	0800015R	CAP.-ELECTRO. 10UF-M 16V
C052	0800015R	CAP.-ELECTRO. 10UF-M 16V
C053	0800015R	CAP.-ELECTRO. 10UF-M 16V
C101	0800048R	CAP.-ELECTRO. 100UF-M 10V
C102	0880016R	CAP.-POLYESTER FILM 0.1UF 50V
C102A	0880016R	CAP.-POLYESTER FILM 0.1UF 50V
C103	0880009R	CAP.-POLYESTER 0.01UF-K 50V
C104	0800015R	CAP.-ELECTRO. 10UF-M 16V
C1101	0800072R	CAP.-ELECTRO. 470UF-M 6.3V
C1102	0890067R	CAP.-CERAMIC 33PF-J 50V
C1103	0890069R	CAP.-CERAMIC 47PF-J 50V
C1107	0890075R	CAP.-CERAMIC 120PF-K 50V
C1108	0890075R	CAP.-CERAMIC 120PF-K 50V
C1109	0890075R	CAP.-CERAMIC 120PF-K 50V
C1111	0270734R	CAP.-MYL 0 1UF 50V
C1117	0800003R	CAP.-ELECTRO. 1.0UF-M 50V
C1118	0800003R	CAP.-ELECTRO. 1.0UF-M 50V
C1119	0800003R	CAP.-ELECTRO. 1.0UF-M 50V
C1120	0800007R	CAP.-ELECTRO. 3.3UF-M 50V
C1124	0880016R	CAP.-POLYESTER FILM 0.1UF 50V
C1125	0880013R	MYLAR CAPACITOR 0.033UF
C1126	0890122R	CAP.-CERAMIC 39PF-J 50V
C1127	0880014R	MYLAR CAPACITOR 0.047U
C1128	0880014R	MYLAR CAPACITOR 0.047U
C1129	0880003R	MYLAR CAPACITOR 0.001U
C1130	0880008R	MYLAR CAPACITOR 6800P
C1133	0880009R	CAP.-POLYESTER 0.01UF-K 50V
C1135	0880044R	CAP.-POLYESTER 0.01UF-KEB 50V





PRODUCT SAFETY NOTE : Components marked with a  have special characteristics important to safety. Before replacing any of these components, read carefully the **PRODUCT SAFETY NOTICE** of this Service Manual. Don't degrade the safety of the receiver through improper servicing

SYMBOL NO.	PART NO.	DESCRIPTION
C1136	0800048R	CAP.-ELECTRO. 100UF-M 10V
C1145	0890072R	CAP.-CERAMIC 68PF-J 50V
C1170	0800057R	CAP.-ELECTRO. 220UF-M 10V
C201	0890087R	CAP.-CERAMIC 1000PF-K 50V
C202	0890087R	CAP.-CERAMIC 1000PF-K 50V (CMT 2097, CMT 2077)
C202A	0880062R	CAP.-POLYESTER 0.22UF-KEB 50V (CMT 2097, CMT 2077)
C205	0800003R	CAP.-ELECTRO. 1.0UF-M 50V
C206	0800366N	CAP.-ELECTRO. 2200UF-10V SMG
C207	0880016R	CAP.-POLYESTER FILM 0.1UF 50V
C208	0880016R	CAP.-POLYESTER FILM 0.1UF 50V
C209	0800057R	CAP.-ELECTRO. 220UF-M 10V
C212	0880009R	CAP.-POLYESTER 0.01UF-K 50V
C213	0800001R	CAP.-ELECTRO. 0.47UF-M 50V (SME)
C215	0880016R	CAP.-POLYESTER FILM 0.1UF 50V
C220	0880009R	CAP.-POLYESTER 0.01UF-K 50V
C221	0880009R	CAP.-POLYESTER 0.01UF-K 50V (CMT 2097)
C225	0880009R	CAP.-POLYESTER 0.01UF-K 50V (CMT 2097)
C230	0880009R	CAP.-POLYESTER 0.01UF-K 50V (CMT 2097)
C231	0800049R	CAP.-ELECTRO. 100UF-M 16V (CMT 2097)
C240	0880009R	CAP.-POLYESTER 0.01UF-K 50V (CMT 2091)
C250	0890118R	CAP.-CERAMIC 22PF-J CH 50V
C251	0880016R	CAP.-POLYESTER FILM 0.1UF 50V
C251A	0800366N	CAP.-ELECTRO. 2200UF-10V SMG (CPT 2090)
C302	0880014R	MYLAR CAPACITOR 0.047U
C304	0880016R	CAP.-POLYESTER FILM 0.1UF 50V
C305	0880016R	CAP.-POLYESTER FILM 0.1UF 50V
C306	0880016R	CAP.-POLYESTER FILM 0.1UF 50V
C310	0800015R	CAP.-ELECTRO. 10UF-M 16V
C311	0800015R	CAP.-ELECTRO. 10UF-M 16V
C312	0800015R	CAP.-ELECTRO. 10UF-M 16V
C313	0800048R	CAP.-ELECTRO. 100UF-M 10V
C350	0880009R	CAP.-POLYESTER 0.01UF-K 50V
C351	0880005R	MYLAR CAPACITOR 0.0022U (CMT 2097)
C401	0890066R	CAP.CERAMIC 27PF-J 50V (CPT 2090)
C401	0890069R	CAP.-CERAMIC 47PF-J 50V (CMT 2097, CMT 2077)
C402	0880009R	CAP.-POLYESTER 0.01UF-K 50V (CMT 2097, CMT2077)
C402	0890067R	CAP.-CERAMIC 33PF-J 50V (CPT 2090)
C408	0800015R	CAP.-ELECTRO. 10UF-M 16V
C410	0800041R	CAP.-ELECTRO. 47UF-M 16V
C411	0800049R	CAP.-ELECTRO. 100UF-M 16V
C412	0800049R	CAP.-ELECTRO. 100UF-M 16V
C413	0800049R	CAP.-ELECTRO. 100UF-M 16V
C415	0880016R	CAP.-POLYESTER FILM 0.1UF 50V
C416	0880016R	CAP.-POLYESTER FILM 0.1UF 50V
C417	0800041R	CAP.-ELECTRO. 47UF-M 16V
C418	0800074N	CAP.-ELECTRO. 470UF-M 16V
C419	0800074N	CAP.-ELECTRO. 470UF-M 16V
C422	0880009R	CAP.-POLYESTER 0.01UF-K 50V
C425	0880009R	CAP.-POLYESTER 0.01UF-K 50V
C427	0800015R	CAP.-ELECTRO. 10UF-M 16V
C428	0880016R	CAP.-POLYESTER FILM 0.1UF 50V
C432	0880004R	MYLAR CAPACITOR 0.0015U





PRODUCT SAFETY NOTE : Components marked with a  have special characteristics important to safety. Before replacing any of these components, read carefully the **PRODUCT SAFETY NOTICE** of this Service Manual. Don't degrade the safety of the receiver through improper servicing

SYMBOL NO.	PART NO.	DESCRIPTION
C433	0880005R	MYLAR CAPACITOR 0.0022U
C440	0284623R	CAP.-ELECTRO. 1UF-SME (BP) 50V
C441	0800041R	CAP.-ELECTRO. 47UF-M 16V (CMT 2097)
C445	0800082F	CAP.-ELECTRO. 1000UF-M 16V
C445B	0800015R	CAP.-ELECTRO. 10UF-M 16V (CMT 2097)
C501	0890116R	CAP.-CERAMIC 15PF-J CH 50V
C502	0880007R	MYLAR CAPACITOR 0.0047UF 50V
C503	0880016R	CAP.-POLYESTER FILM 0.1UF 50V
C504	0800015R	CAP.-ELECTRO. 10UF-M 16V
C506	0800015R	CAP.-ELECTRO. 10UF-M 16V
C509	0800048R	CAP.-ELECTRO. 100UF-M 10V
C510	0890087R	CAP.-CERAMIC 1000PF-K 50V
C511	0890087R	CAP.-CERAMIC 1000PF-K 50V
C512	0800049R	CAP.-ELECTRO. 100UF-M 16V (CMT 2097, CMT 2077)
C513	0880016R	CAP.-POLYESTER FILM 0.1UF 50V (CMT 2097, CMT 2077)
C514	0880018R	CAP.-POLYESTER FILM 0.22UF-K 50V (CMT 2097, CMT 2077)
C515	0880016R	CAP.-POLYESTER FILM 0.1UF 50V
C516	0880016R	CAP.-POLYESTER FILM 0.1UF 50V
C517	0890061R	CAP.-CERAMIC 10PF-50V
C520	0890116R	CAP.-CERAMIC 15PF-J CH 50V
C522	0890083R	CAP.-CERAMIC 470PF-K 50V (CMT 2097, CPT 2090)
C522	0890084R	CAP.-CERAMIC 560PF-K 50V (CMT 2077)
C525	0284667R	CAP.-ELECTRO. 47UF-MBPR (SME) 16V (CMT 2097)
C526	0890078R	CAP.-CERAMIC 220PF-K 50V (CMT 2077)
C551	0890067R	CAP.-CERAMIC 33PF-J 50V
C552	0880016R	CAP.-POLYESTER FILM 0.1UF 50V
C601	0880016R	CAP.-POLYESTER FILM 0.1UF 50V
C602	0880044R	CAP.-POLYESTER 0.01UF-KEB 50V
C604	0249093R	CAPACITOR - CERAMIC 470PF-J SL 50WV
C605	0800052R	CAP.-ELECTRO. 100UF-M 35V
C606	0880011R	MYLAR CAPACITOR 0.015UF
C607	0279693	CAP.-POLY.FLM 0.1UF-K 100V
C608	0800009R	CAP.-ELECTRO. 4.7UF-M 25V
C609	0800082N	CAP.-ELECTRO. 1000UF-MB 16V (SME)
C620	0800015R	CAP.-ELECTRO. 10UF-M 16V
C683	0880017R	CAP.-POLYESTER 0.15MF-M 50V
C701	0880007R	MYLAR CAPACITOR 0.0047UF 50V
C702	0800003R	CAP.-ELECTRO. 1.0UF-M 50V
C703	0880005R	MYLAR CAPACITOR 0.0022U
C705	0800073R	CAP.-ELECTRO. 470UF-M 10V
C710	0880016R	CAP.-POLYESTER FILM 0.1UF 50V
C710A	0880016R	CAP.-POLYESTER FILM 0.1UF 50V
C723	0279351F	CAPACITOR-POLYESTER FILM 0.022UF-K
C725	0800352R	CAP.-ELECTRO. 470UF 10V
C727	0880009R	CAP.-POLYESTER 0.01UF-K 50V
C752	0244501R	CAP.-CERAMIC 1000PF-K 500V
C753	0244501R	CAP.-CERAMIC 1000PF-K 500V
C754	0800076N	CAP.-ELECTRO 470UF-M 35V
C755	0800058R	CAP.-ELECTRO. 220UF-M 16V
C756	0253973F	CAP.-ELECTRO. 22UF-M 250V
C758	0880016R	CAP.-POLYESTER FILM 0.1UF 50V
 C781	0262424F	CAP.-POLYPRO.FILM 7500PF-J 1.8 KV

PRODUCT SAFETY NOTE : Components marked with a  have special characteristics important to safety. Before replacing any of these components, read carefully the **PRODUCT SAFETY NOTICE** of this Service Manual. Don't degrade the safety of the receiver through improper servicing

SYMBOL NO.	PART NO.	DESCRIPTION
 C782	0244211	CAP.-CERAMIC 1000PF-K 2KV
 C783	0244212	CAP.-CERAMIC 1200PF-K 2KV
 C784	0262803F	CAP.-POLYPRO. 0.68UF-J 250V
C786	0243512R	CAP.-CERAMIC 820PF-K 500V TAPE
C787	0800056R	CAP.-ELECTRO. 220UF-M 6.3V
C789	0890077R	CAP.-CERAMIC 180PF-K 50V
C790	0244501R	CAP.-CERAMIC 1000PF-K 500V
C791	0890055R	CAP.-CERAMIC 5PF 50V
C801	0890083R	CAP.-CERAMIC 470PF-K 50V
C802	0890082R	CAP.-CERAMIC 390PF-K 50V
C803	0890084R	CAP.-CERAMIC 560PF-K 50V
C805	0245612F	CAP.-CERAMIC 4700PF-KF B 1KV
C810	0800359R	CAP.-ELECTRO. 1000UF-M 10V
C901	0262773	CAP.-POLYPRO 0.1UF 250V (CMT 2077-191,CPT 2090)
C901	0262774	CAP.POLYPRO 0.22UF 250V (CMT 2097, CMT 2077-192 R)
C902	0248593F	CAP.-CERAMIC 4700PF-Z 250V
C903	0248593F	CAP.-CERAMIC 4700PF-Z 250V
C904	0248594F	CERAMIC CONDENSER (0.01 AC 250V)
C905	0255506N	CAP.-ELECTRO. 10UF-M 160V (KME) (CPT 2090)
C905	0255507F	CAP.-ELECTRO. 22UF-MB 160V (KME) (CMT 2097, CMT 2077)
C906	AL00095	ALUMINIUM ELECTROLYTIC CAPACITOR 33 (CMT 2097, CMT 2077)
C906	0259401F	CAP.-ELECTRO. 82UF-MF 400V (CPT 2090)
C907	0245608R	CAP.-CERAMIC 1000PF-K 1KV
C908	0243504R	CAPACITOR-CERAMIC 180PF-K 500V TAPE
C910	0880062R	CAP.-POLYESTER 0.22UF-KEB 50V
C912	0244725	CAP.-CERAMIC 1000PF-K 2.0KV B
C914	0258129F	CAP.-ELECTRO. 220UF-100V
C915	0800015R	CAP.-ELECTRO. 10UF-M 16V
C916	0800087F	CAP.-ELECTRO. 2200UF-M 16V
C917	0243504R	CAPASITOR-CERAMIC 180PF-K 500V TAPE
C918	0890029M	CAP.-CERAMIC 390PF-K B 50V CYLI
C919	0245605R	CAP.-CERAMIC 470PF-K 1.0KV B
C920	0245605R	CAP.-CERAMIC 470PF 100V
C921	0247842R	CAP.-CERAMIC 33PF-SL 500V
 C998	0249498F	CAPASITOR CERAMIC (102PF---V)
 C999	0247974F	CAPASITOR CERAMIC (222PF---V)
DR1166	2338321M	DIODE 1SS270 (TA)
DR1201	2338321M	DIODE 1SS270 (TA)
D1101	2338321M	DIODE 1SS270 (TA)
D1102	2338321M	DIODE 1SS270 (TA)
D1105	2338321M	DIODE 1SS270 (TA)
D1109	2338321M	DIODE 1SS270 (TA)
D1110	2338321M	DIODE 1SS270 (TA) (CMT 2097)
D1111	2338321M	DIODE 1SS270 (TA) (CMT 2097, CMT 2077)
D1112	2338321M	DIODE 1SS270 (TA)
D1114	2339691	LED SLH-56VC77F (RED)
D1120	2338321M	DIODE 1SS270 (TA)
D1121	2338321M	DIODE 1SS270 (TA)
D1122	2338321M	DIODE 1SS270 (TA)
D1123	2338321M	DIODE 1SS270 (TA) (CMT 2097)
D201	2338321M	DIODE 1SS270 (TA) (CMT 2097)
D202	2338321M	DIODE 1SS270 (TA) (CMT 2097)

PRODUCT SAFETY NOTE : Components marked with a  have special characteristics important to safety. Before replacing any of these components, read carefully the **PRODUCT SAFETY NOTICE** of this Service Manual. Don't degrade the safety of the receiver through improper servicing

SYMBOL NO.	PART NO.	DESCRIPTION
D205	2338321M	DIODE 1SS270 (TA) (CMT 2097)
D206	2338321M	DIODE 1SS270 (TA) (CMT 2097)
D401	2333001	DIODE RU2M
D501	2338321M	DIODE 1SS270 (TA)
D502	2338321M	DIODE 1SS270 (TA)
D601	2339491M	DIODE AM01Z (200 TAPE)
D612	2338321M	DIODE 1SS270 (TA)
D702	2338321M	DIODE 1SS270 (TA)
D720	2338321M	DIODE 1SS270 (TA)
D739	2338321M	DIODE 1SS270 (TA)
D751	2339482M	DIODE AS01 (400 TAPE)
D752	2339482M	DIODE AS01 (400 TAPE)
D753	2339481M	DIODE AS01Z (200 TAPE)
D753A	2338321M	DIODE 1SS270 (TA)
D757	2338321M	DIODE 1SS270 (TA)
D758	2338321M	DIODE 1SS270 (TA)
D760	2338321M	DIODE 1SS270 (TA)
D802	2338321M	DIODE 1SS270 (TA)
D804	2338321M	DIODE 1SS270 (TA)
D810	2338321M	DIODE 1SS270 (TA)
D811	2338321M	DIODE 1SS270 (TA)
D812	2338321M	DIODE 1SS270 (TA)
D901	2342711M	DIODE EM2A TAPE
D902	2342711M	DIODE EM2A TAPE
D903	2342711M	DIODE EM2A TAPE
D904	2342711M	DIODE EM2A TAPE
D905	2349971	DIODE FMG-G2CS
D907	2343961M	DIODE MPG06D G23 TA
D908	2333001	DIODE RU2M
D909	2342861M	DIODE R2G
D910	2342711M	DIODE EM2A TAPE
D950	2338321M	DIODE 1SS270 (TA)
EMH	2665279	4P PLUG PIN
EMV	2663132	3P PLUG PIN WITH BASE
E201	2997075	CONNECTOR PIN TXC-P07P-A1 (CMT 2097)
E203	2122652M	FERRITE CORE
E301	2695251	4P JACK
E402	2902261	PLUG PIN SUB MINI 2P
E403	2902262	PLUG PIN SUB MINI 3P
E601	2611331	3P SWITCH
E611	2122652M	FERRITE CORE
 E801	2698352	CPT SOCKET
E802	2661751	2P PLUG PIN WITH BASE
E805	2995604	8P CONNECTOR L=350
 E903	EV00001	POWER CORD (AUSTRALIA) (CPT 2090)
 E903	2972581	POWER CORD (CMT 2077 -191)
 E903	2972591	POWER CORD CEE (CMT 2097, CMT 2077-192R)
E904	2661753	4P PLUG PIN WITH BASE
E906	2720221	FUSE HOLDER
E907	2995909	AMP-IN CONNECTOR UL1672 L=220
E950	3721832	UNI TIE FASTNER
FBK283	2122652M	FERRITE CORE

PRODUCT SAFETY NOTE : Components marked with a \triangle have special characteristics important to safety. Before replacing any of these components, read carefully the **PRODUCT SAFETY NOTICE** of this Service Manual. Don't degrade the safety of the receiver through improper servicing

SYMBOL NO.	PART NO.	DESCRIPTION
FB601	2122653M	FERRITE CORE 1.65UH TAPE
FB781	2122653M	FERRITE CORE 1.65UH TAPE
FB901	2123468M	FERRITE BEADS CORE LEAD 0.8MH
FB902	2123468M	FERRITE BEADS CORE LEAD 0.8MH
FB903	2123468M	FERRITE BEADS CORE LEAD 0.8MH
FB904	2123468M	FERRITE BEADS CORE LEAD 0.8MH
FB905	2123468M	FERRITE BEADS CORE LEAD 0.8MH
FB906	2774731R	COIL-FERRITE BEADS CORE LEAD
FB907	2771892	FERRITE BEADS CORE (004)
FB908	2771892	FERRITE BEADS CORE (004)
FB909	2771892	FERRITE BEADS CORE (004)
\triangle F901	2720402	FUSE 3.15A IEC-127
IC001	2004801	IC LA7920
\triangle IC1101	2001929	IC M37210M4-650SP
IC1102	2381112	IC M6M80021P
IC201	2004415	ANALOG MONO IC (TDA 8362)-N5
IC4501	2004022	IC AN7147N
IC451	2020601	IC MM1053XS
IC501	CP02611	IC TDA 4665
IC502	2004431	IC TDA8395 (CMT 2097, CMT 2077)
IC681	2020631	IC AN5515
IC901	2373372	IC STR-D5095A
\triangle IC902	2004761	IC TLP631
L101	2122253M	COIL-AXIAL 100UH-K
L1101	2123739R	RADIAL COIL 1UH-M TYPE EL0405
L1102	2123298M	LAL AXIAL COIL 22UH-J
L1103	2122956M	COIL-AXIAL 100UHKM BELTING
L201	2123103M	COIL-AXIAL LAL 10UH-K (CMT 2097, CMT 2077)
L202	2146114	COIL 7MM
L203	2123411M	AXIAL COIL 1.0UH-K TYPE LAL02 (CMT 2097)
L203	2123413M	AXIAL COIL 1.5UH TYPE LAL02 (CMT 2077)
L204	2123411M	AXIAL COIL 1.0UH-K TYPE LAL02 (CMT2097)
L205	2123412M	LAL AXIAL COIL 1.2UH (CMT 2097)
L205	2123415M	LAL AXIAL COIL 2.2UH-K (CMT 2077)
L206	2122956M	COIL AXIAL 100UHKM BELTING
L401	2123104M	COIL AXIAL 12UH-K (CMT 2097, CMT 2077)
L401	2123107M	LAL02 AXIAL COIL 22UH-K (CPT 2090)
L402	2123107M	LAL02 AXIAL COIL 22UH-K (CPT 2090)
L501	2123102M	COIL-AXIAL 8.2UH-K (CMT 2097, CMT 2077)
L502	2123104M	COIL-AXIAL 12UH-K (CMT 2097, CPT 2090)
L505	2122253M	COIL-AXIAL 100UH-K (CMT 2097)
L507	2123103M	COIL-AXIAL LAL 10UH-K (CMT 2097, CMT 2077)
L553	2122946M	COIL-AXIAL 18UHKM BELTING
L768	2122253M	COIL-AXIAL 100UH-K
L781	2164541	HORIZONTAL LINERARITY COIL
L802	BH00204R	FILTER COIL 18UH
L901	2122694	LINE FILTER (CPT 2090)
L901	2272391	LINE FILTER (CMT 2097, CMT 2077)
MF401	2167211	CERAMIC FILTER SFSL5.5MH (CPT 2090)
MF401	2167311	FILTER CERAMIC (4.5MHZ) (CMT 2097)
MF402	2167211	CERAMIC FILTER SFSL5.5MH (CMT 2097, CMT 2077)
MF403	2167212	CERAMIC FILTER SFSL6.0MDB (CMT 2097, CMT 2077)

PRODUCT SAFETY NOTE : Components marked with a  have special characteristics important to safety. Before replacing any of these components, read carefully the **PRODUCT SAFETY NOTICE** of this Service Manual. Don't degrade the safety of the receiver through improper servicing

SYMBOL NO.	PART NO.	DESCRIPTION
MF404	2167213	CERAMIC FILTER SFSL6.5MDB (CMT 2097, CMT 2077)
MF501	2167371	CERAMIC TRAP COIL 5.5/5.75MHZ (CMT 2097, CMT 2077)
MF502	2143472	COMPOUND TRAP 6/6.5 MHZ (CMT 2097, CMT 2077)
MF503	2142241	CERAMIC TRAP 4.5MHZ (CMT 2097)
MF503	2167371	CERAMIC TRAP COIL5.5/5.75MHZ (CPT 2090)
Q1101	2327773M	TRS. 2SC3413 TAPE
Q1102	2327774M	TRS. 2SC3413D-TZ
Q1104	2327773M	TRS.2SC3413 TAPE
Q1105	2003522R	IC PST572D-2 (ANALOG IC)
Q1106	2327773M	TRS.2SC3413 TAPE
Q201	2320144M	TRS.2SC1906 (TAPE)
Q203	2326875R	DIGITAL TRS. DTC144WS (CMT 2097)
Q204	2327774M	TRS. 2SC3413D-TZ (CMT 2097)
Q205	2327774M	TRS. 2SC3413D-TZ (CMT 2097)
Q301	2327753M	TRS.2SA1390 TAPE (C/D)
Q303	2326875R	DIGITAL TRS. DTC144WS
Q401	2327773M	TRS.2SC3413 TAPE
Q402	2327773M	TRS.2SC3413 TAPE
Q501	2327773M	TRS.2SC3413 TAPE (CMT 2097, CMT 2077)
Q502	2327773M	TRS.2SC3413 TAPE (CMT 2097, CPT 2090)
Q506	2327773M	TRS.2SC3413 TAPE
Q507	2327753M	TRS.2SA1390 TAPE (C/D)
Q510	2327773M	TRS.2SC3413 TAPE
Q721	CF00112R	TRS. 2SC4490-AN(R-300V)
Q723	2312171	TRS. 2SC3852 (CPT2090)
Q723	2323052	TRS. 2SD787 (D/E)
Q724	2327753M	TRS. 2SA1390 TAPE (C/D)
Q781	2315161	TRS. BU2508DF
Q801	2327754M	TRS. 2SA1390D
Q851	2312371	TRS. 2SC3942
Q852	2312371	TRS. 2SC3942
Q853	2312371	TRS. 2SC3942
 Q901	2326631	THYRISTOR CR5AS-8(B-A1)
Q902	2327754M	TRS. 2SA1390D
Q903	2327773M	TRS. 2SC3413 TAPE
Q904	2315933	TRS. 2SB1548A P/Q
Q905	2320647M	TRS. 2SC1213 (C 21 TZ/D 21 TZ)
RK108	0700041M	RES.-CARBON FLM 1/16W 1.0K-Ω
R001	0700053M	RES.-CARBON FLM 1/16W 8.2K-Ω
R1001	0700041M	RES.-CARBON FLM 1/16W 1.0K-Ω
R101	0700058M	RES.-CARBON FLM 1/16W 22K-Ω
R1101	0110223S	RES.-MTL OXIDE FLM 120-Ω
R1102	0700051M	RES.-CARBON FLM 1/16W 5.6K-Ω
R1103	0700027M	RES.-CARBON FLM 1/16W 100-Ω
R1104	0700027M	RES.-CARBON FLM 1/16W 100-Ω
R1106	0700041M	RES.-CARBON FLM 1/16W 1.0K-Ω
R1107	0700054M	RES.-CARBON FLM 1/16W 10K-Ω
R1108	0700058M	RES.-CARBON FLM 1/16W 22K-Ω
R1109	0700058M	RES.-CARBON FLM 1/16W 22K-Ω
R1110	0700058M	RES.-CARBON FLM 1/16W 22K-Ω
R1111	0700027M	RES.-CARBON FLM 1/16W 100-Ω
R1112	0700027M	RES.-CARBON FLM 1/16W 100-Ω



PRODUCT SAFETY NOTE : Components marked with a  have special characteristics important to safety. Before replacing any of these components, read carefully the **PRODUCT SAFETY NOTICE** of this Service Manual. Don't degrade the safety of the receiver through improper servicing

SYMBOL NO.	PART NO.	DESCRIPTION
R1113	0700027M	RES.-CARBON FLM 1/16W 100-Ω
R1118	0700064M	RES.-CARBON FLM 1/16W 56K-Ω (CMT 2077, CPT 2090)
R1118	0700067M	RES.-CARBON FLM 1/16W 100K-Ω (CMT 2097)
R1119	0700035M	RES.-CARBON FLM 1/16W 390-Ω (CMT 2077, CPT 2090)
R1119	0700055M	RES.-CARBON FLM 1/16W 12K-Ω (CMT 2097)
R1120	0700035M	RES.-CARBON FLM 1/16W 390-Ω (CMT 2097, CMT 2077)
R1121	0700035M	RES.-CARBON FLM 1/16W 390-Ω (CMT 2097, CMT 2077)
R1123	0700041M	RES.-CARBON FLM 1/16W 1.0K-Ω
R1125	0700048M	RES.-CARBON FLM 1/16W 3.9K-Ω
R1126	0700048M	RES.-CARBON FLM 1/16W 3.9K-Ω
R1127	0700048M	RES.-CARBON FLM 1/16W 3.9K-Ω
R1128	0700055M	RES.-CARBON FLM 1/16W 12K-Ω
R1129	0700054M	RES.-CARBON FLM 1/16W 10K-Ω
R1130	0700054M	RES.-CARBON FLM 1/16W 10K-Ω
R1132	0700046M	RES.-CARBON FLM 1/16W 2.7K-Ω
R1133	0700053M	RES.-CARBON FLM 1/16W 8.2K-Ω
R1134	0700039M	RES.-CARBON FLM 1/16W 820-Ω
R1135	0700054M	RES.-CARBON FLM 1/16W 10K-Ω
R1136	0700054M	RES.-CARBON FLM 1/16W 10K-Ω
R1137	0700045M	RES.-CARBON FLM 1/16W 2.2K-Ω
R1138	0100081M	RES.-CARBON FLM 1/8W 4.7K-Ω
R1139	0700054M	RES.-CARBON FLM 1/16W 10K-Ω
R1139A	0187084M	RES.-CARBON FLM 1/16W 6.2K-Ω (CMT 2097)
R1139A	0700049M	RES.-CARBON FLM 1/16W 4.7K-Ω (CMT 2077, CPT 2090)
R1140	0700054M	RES.-CARBON FLM 1/16W 10K-Ω
R1141	0700055M	RES.-CARBON FLM 1/16W 12K-Ω
R1142	0700052M	RES.-CARBON FLM 1/16W 6.8K-Ω
R1143	0700056M	RES.-CARBON FLM 1/16W 15K-Ω
R1144	0700052M	RES.-CARBON FLM 1/16W 6.8K-Ω
R1145	0700052M	RES.-CARBON FLM 1/16W 6.8K-Ω
R1146	0700051M	RES.-CARBON FLM 1/16W 5.6K-Ω
R1147	0700027M	RES.-CARBON FLM 1/16W 100-Ω
R1148	0700027M	RES.-CARBON FLM 1/16W 100-Ω
R1149	0700041M	RES.-CARBON FLM 1/16W 1.0K-Ω
R1150	0700041M	RES.-CARBON FLM 1/16W 1.0K-Ω
R1151	0700054M	RES.-CARBON FLM 1/16W 10K-Ω
R1154	0700061M	RES.-CARBON FLM 1/16W 33K-Ω
R1155	0700058M	RES.-CARBON FLM 1/16W 22K-Ω
R1156	0700058M	RES.-CARBON FLM 1/16W 22K-Ω
R1157	0700045M	RES.-CARBON FLM 1/16W 2.2-Ω
R1158	0700045M	RES.-CARBON FLM 1/16W 2.2K-Ω
R1159	0700027M	RES.-CARBON FLM 1/16W 100-Ω
R1160	0700041M	RES.-CARBON FLM 1/16W 1.0K-Ω
R1161	0700041M	RES.-CARBON FLM 1/16W 1.0K-Ω
R1162	0700056M	RES.-CARBON FLM 1/16W 15K-Ω
R1163	0700056M	RES.-CARBON FLM 1/16W 15K-Ω
R1165	0700041M	RES.-CARBON FLM 1/16W 1.0K-Ω
R1166	0700051M	RES.-CARBON FLM 1/16W 5.6K-Ω
R1167	0700054M	RES.-CARBON FLM 1/16W 10K-Ω
R1168	0700054M	RES.-CARBON FLM 1/16W 10K-Ω
R1169	0700062M	RES.-CARBON FLM 1/16W 39K-Ω
R1170	0700062M	RES.-CARBON FLM 1/16W 39K-Ω









PRODUCT SAFETY NOTE : Components marked with a  have special characteristics important to safety. Before replacing any of these components, read carefully the **PRODUCT SAFETY NOTICE** of this Service Manual. Don't degrade the safety of the receiver through improper servicing

SYMBOL NO.	PART NO.	DESCRIPTION
R1171	0700056M	RES.-CARBON FLM 1/16W 15K-Ω
R1172	0700054M	RES.-CARBON FLM 1/16W 10K-Ω
R1176	0700054M	RES.-CARBON FLM 1/16W 10K-Ω
R1177	0700061M	RES.-CARBON FLM 1/16W 33K-Ω
R1179	0700043M	RES.-CARBON FLM 1/16W 1.5K-Ω
R1180	0700041M	RES.-CARBON FLM 1/16W 1.0K-Ω
R1181	0700064M	RES.-CARBON FLM 1/16W 56K-Ω
R1182	0700054M	RES.-CARBON FLM 1/16W 10K-Ω
R1183	0700066M	RES.-CARBON FLM 1/16W 82K-Ω
R1184	0700054M	RES.-CARBON FLM 1/16W 10K-Ω
R1185	0700058M	RES.-CARBON FLM 1/16W 22K-Ω
R1190	0700038M	RES.-CARBON FLM 1/16W 680-Ω
R1191	0700038M	RES.-CARBON FLM 1/16W 680-Ω
R1192	0700038M	RES.-CARBON FLM 1/16W 680-Ω
R1194	0700052M	RES.-CARBON FLM 1/16W 6.8K-Ω
R1195	0700042M	RES.-CARBON FLM 1/16W 1.2K-Ω
R1200	0700057M	RES.-CARBON FLM 1/16W 18K-Ω
R1202	0700041M	RES.-CARBON FLM 1/16W 1.0K-Ω
R1203	0700038M	RES.-CARBON FLM 1/16W 680-Ω
R1204	0700061M	RES.-CARBON FLM 1/16W 33K-Ω (CMT 2097)
R1205	0700065M	RES.-CARBON FLM 1/16W 68K-Ω (CMT 2097)
R1206	0700062M	RES.-CARBON FLM 1/16W 39K-Ω (CMT 2097)
R201	0700048M	RES.-CARBON FLM 1/16W 3.9K-Ω (CPT 2090)
R201	0700052M	RES.-CARBON FLM 1/16W 6.8K-Ω (CMT 2097, CMT 2077)
R202	0700037M	RES.-CARBON FLM 1/16W 560-Ω (CPT 2090)
R202	0700042M	RES.-CARBON FLM 1/16W 1.2K-Ω (CMT 2097, CMT 2077)
R203	0100047M	RES.-CARBON FLM 1/8W 180-Ω
R204	0700019M	RES.-CARBON FLM 1/16W 27-Ω
R207	0700054M	RES.-CARBON FLM 1/16W 10K-Ω
R208	0700027M	RES.-CARBON FLM 1/16W 100-Ω
R209	0700062M	RES.-CARBON FLM 1/16W 39K-Ω
R210	0700058M	RES.-CARBON FLM 1/16W 22K-Ω
R214	0700055M	RES.-CARBON FLM 1/16W 12K-Ω
R215	0700026M	RES.-CARBON 1/16P 82-Ω
R221	0700045M	RES.-CARBON FLM 1/16W 2.2K-Ω (CMT 2097)
R225	0700027M	RES.-CARBON FLM 1/16W 100-Ω (CMT 2097)
R230	0700041M	RES.-CARBON FLM 1/16W 1.0K-Ω (CMT 2097)
R231	0700041M	RES.-CARBON FLM 1/16W 1.0K-Ω (CMT 2097)
R232	0700054M	RES.-CARBON FLM 1/16W 10K-Ω (CMT 2097)
R234	0700048M	RES.-CARBON FLM 1/16W 3.9K-Ω (CMT 2097)
 R240	0119687M	RES.-CARBON FLM 1/16W 4.7K-Ω
R250	0700032M	RES.-CARBON FLM 1/16W 220-Ω
R260	0700041M	RES.-CARBON FLM 1/16W 1.0K-Ω
R265	0700058M	RES.-CARBON FLM 1/16W 22K-Ω (CMT 2097)
R266	0700053M	RES.-CARBON FLM 1/16W 8.2K-Ω (CMT 2097)
R267	0700063M	RES.-CARBON FLM 1/16W 47K-Ω (CMT 2097)
R268	0700058M	RES.-CARBON FLM 1/16W 22K-Ω (CMT 2097)
R302	0100038M	RES.-CARBON FLM 1/8W 75-Ω
R303	0700027M	RES.-CARBON FLM 1/16W 100-Ω
R304	0700067M	RES.-CARBON FLM 1/16W 100K-Ω
R305	0700027M	RES.-CARBON FLM 1/16W 100-Ω (CMT 2077, CPT 2090)
R305	0700058M	RES.-CARBON FLM 1/16W 22K-Ω (CMT 2097)



PRODUCT SAFETY NOTE : Components marked with a  have special characteristics important to safety. Before replacing any of these components, read carefully the **PRODUCT SAFETY NOTICE** of this Service Manual. Don't degrade the safety of the receiver through improper servicing

SYMBOL NO.	PART NO.	DESCRIPTION
R306	0700067M	RES.-CARBON FLM 1/16W 100K-Ω
R307	0700027M	RES.-CARBON FLM 1/16W 100-Ω
R308	0700025M	RES.-CARBON FLM 1/16W 68-Ω
R309	0100045M	RES.-CARBON FLM 1/16W 150-Ω
R310	0700027M	RES.-CARBON FLM 1/16W 100-Ω
R320	0700067M	RES.-CARBON FLM 1/16W 100K-Ω
R321	0700034M	RES.-CARBON FLM 1/16W 330-Ω
R332	0700057M	RES.-CARBON FLM 1/16W 18K-Ω
R340	0700043M	RES.-CARBON FLM 1/16W 1.5K-Ω (CMT 2097)
R401	0700027M	RES.-CARBON FLM 1/16W 100-Ω (CPT 2090)
R401	0700035M	RES.-CARBON FLM 1/16W 390-Ω (CMT 2097, CMT 2077)
 R404	0119505S	RES.-MTL FLM 1/4W 2.2-Ω
 R405	0119505S	RES.-MTL FLM 1/4W 2.2-Ω
R410	0700036M	RES.-CARBON FLM 1/16W 470-Ω
R411	0700036M	RES.-CARBON FLM 1/16W 470-Ω
R413	0700051M	RES.-CARBON FLM 1/16W 5.6K-Ω
R419	0700058M	RES.-CARBON FLM 1/16W 22K-Ω (CMT 2077, CPT 2090)
R419	0700067M	RES.-CARBON FLM 1/16W 100K-Ω (CMT 2097)
R427	0700041M	RES.-CARBON FLM 1/16W 1.0K-Ω
R430	0700043M	RES.-CARBON FLM 1/16W 1.5K-Ω (CMT 2097)
R451	0700041M	RES.-CARBON FLM 1/16W 1.0K-Ω
R451A	0100035M	RES.-CARBON FLM 1/8W 56-Ω (CMT 2097, CMT 2077)
R502	0700031M	RES.-CARBON FLM 1/16W 180-Ω (CMT 2097, CMT 2077)
R503	0700031M	RES.-CARBON FLM 1/16W 180-Ω (CPT 2090)
R503	0700033M	RES.-CARBON FLM 1/16W 270-Ω (CMT 2097)
R504	0700045M	RES.-CARBON FLM 1/16W 2.2-Ω (CMT 2097, CPT 2090)
R505	0100057M	RES.-CARBON FLM 1/8W 470-Ω
R506	0700045M	RES.-CARBON FLM 1/16W 2.2K-Ω (CMT 2097)
R507	0700034M	RES.-CARBON FLM 1/16W 330-Ω (CMT 2097, CMT 2077)
R508	0700052M	RES.-CARBON FLM 1/16W 6.8K-Ω (CMT 2097)
R509	0700067M	RES.-CARBON FLM 1/16W 100K-Ω
R510	0700032M	RES.-CARBON FLM 1/16W 220-Ω (CMT 2077)
R511	0700027M	RES.-CARBON FLM 1/16W 100-Ω
R513	0700027M	RES.-CARBON FLM 1/16W 100-Ω
R515	0700027M	RES.-CARBON FLM 1/16W 100-Ω
R519	0100057M	RES.-CARBON FLM 1/8W 470-Ω
R529	0700027M	RES.-CARBON FLM 1/16W 100-Ω (CMT 2097, CPT 2090)
R530	0700029M	RES.-CARBON FLM 1/16W 150-Ω (CMT 2097, CPT 2090)
R530	0700034M	RES.-CARBON FLM 1/16W 330-Ω (CMT 2077)
R531	0700029M	RES.-CARBON FLM 1/16W 150-Ω (CMT 2077)
R531	0700032M	RES.-CARBON FLM 1/16W 220-Ω (CMT 2097, CPT 2090)
R532	0700031M	RES.-CARBON FLM 1/16W 180-Ω (CMT 2097)
R532	0700032M	RES.-CARBON FLM 1/16W 220-Ω (CPT 2090)
R532	0700033M	RES.-CARBON FLM 1/16W 270-Ω (CMT 2077)
R534	0700032M	RES.-CARBON FLM 1/16W 220-Ω
R535	0700032M	RES.-CARBON FLM 1/16W 220-Ω
R536	0700051M	RES.-CARBON FLM 1/16W 5.6K-Ω
R537	0700032M	RES.-CARBON FLM 1/16W 220-Ω
R538	0700064M	RES.-CARBON FLM 1/16W 56K-Ω
R539	0700032M	RES.-CARBON FLM 1/16W 220-Ω
R551	0700032M	RES.-CARBON FLM 1/16W 220-Ω
R552	0700032M	RES.-CARBON FLM 1/16W 220-Ω





PRODUCT SAFETY NOTE : Components marked with a  have special characteristics important to safety. Before replacing any of these components, read carefully the **PRODUCT SAFETY NOTICE** of this Service Manual. Don't degrade the safety of the receiver through improper servicing

SYMBOL NO.	PART NO.	DESCRIPTION
R553	0700036M	RES.-CARBON FLM 1/16W 470-Ω
R554	0700058M	RES.-CARBON FLM 1/16W 22K-Ω
R555	0700063M	RES.-CARBON FLM 1/16W 47K-Ω
R570	0700027M	RES.-CARBON FLM 1/16W 100-Ω
R571	0114141M	RES.-CARBON FLM 1/4W 270-Ω
 R590	0119508M	RES.-MTL FLM 1/4W 56-Ω (CMT 2097, CMT 2077)
R602	0179557M	RES.-METAL GRAZED FILM 680K-Ω
R604	0700051M	RES.-CARBON FLM 1/16W 5.6K-Ω
R605	0700054M	RES.-CARBON FLM 1/16W 10K-Ω
R606	0700055M	RES.-CARBON FLM 1/16W 12K-Ω
R607	0700029M	RES.-CARBON FLM 1/16W 150-Ω
R608	0700049M	RES.-CARBON FLM 1/16W 4.7K-Ω
R609	0119844M	RES.-MTL OXIDE FLM 2.2-Ω
R612	0113748M	RES.-CARBON FLM 1/2 P-B 820-Ω
R613	0700048M	RES.-CARBON FLM 1/16W 3.9K-Ω
R620	0700067M	RES.-CARBON FLM 1/16W 100K-Ω
R681	0113735M	RES.-CARBON FLM 1/2W 270-Ω
R701	0700056M	RES.-CARBON FLM 1/16W 15K-Ω
R703	0700034M	RES.-CARBON FLM 1/16W 330-Ω
R706	0700059M	RES.-CARBON FLM 1/16W 27K-Ω
R707	0700041M	RES.-CARBON FLM 1/16W 1.0K-Ω
R710	0100131M	RES.-CARBON FLM 1/8W 560K-Ω
R711	0100123M	RES.-CARBON FLM 1/8W 270K-Ω
R712	0100125M	RES.-CARBON FLM 1/8W 330K-Ω
R720	0110251S	RES.-MTL OXIDE FLM 1.8K-Ω
R721	0110247S	RES.-MTL OXIDE FLM 1.2K-Ω
R722	0113746M	RES.-CARBON FLM 1/2W 680-Ω
R723	0100051M	RES.-CARBON FLM 1/8W 270-Ω
R724	0700041M	RES.-CARBON FLM 1/16W 1.0K-Ω
R725	0700054M	RES.-CARBON FLM 1/16W 10K-Ω
 R726	0700063M	RES.-CARBON FLM 1/16W 47K-Ω
R727	0700054M	RES.-CARBON FLM 1/16W 10K-Ω
R730	0700042M	RES.-CARBON FLM 1/16W 1.2K-Ω
R733	0113727M	RESISTOR CARBON FILM SRD1/2P-B 120-
R734	0700014M	RES.-CARBON FLM 1/16W 10-Ω
 R751	0114223M	RESISTOR CARBON FILM SRD 1/4 PB 82K
 R752	0114223M	RESISTOR CARBON FILM SRD 1/4 PB 82K
 R757	0118970M	RES.-METAL FILM 240K-G 1/16W
 R758	0119647M	RES.-MTL FLM 1/8W 47K-FB
R759	0110279S	RES.-MTL OXIDE FILM 27K-Ω
R760	0700041M	RES.-CARBON FLM 1/16W 1.0K-Ω
R761	0700041M	RES.-CARBON FLM 1/16W 1.0K-Ω
R762	0100073M	RES.-CARBON FLM 1/8W 2.2K-Ω
 R764	0119505S	RES.-MTL FLM 1/4W 2.2-Ω
R768	0100077M	RES.-CARBON FLM 1/8W 3.3K-Ω
 R781	0147626	RES.-WIRE WOUND 7W 4.7-JF
R782	0113748M	RES.-CARBON FLM 1/2 P-B 820-Ω
R801	0700027M	RES.-CARBON FLM 1/16W 100-Ω
R802	0700027M	RES.-CARBON FLM 1/16W 100-Ω
R803	0700027M	RES.-CARBON FLM 1/16W 100-Ω
R804	0700033M	RES.-CARBON FLM 1/16W 270-Ω
R805	0700035M	RES.-CARBON FLM 1/16W 390-Ω



PRODUCT SAFETY NOTE : Components marked with a  have special characteristics important to safety. Before replacing any of these components, read carefully the **PRODUCT SAFETY NOTICE** of this Service Manual. Don't degrade the safety of the receiver through improper servicing

SYMBOL NO.	PART NO.	DESCRIPTION
R806	0700033M	RES.-CARBON FLM 1/16W 270-Ω
R807	0700044M	RES.-CARBON FLM 1/16W 1.8K-Ω
R808	0700044M	RES.-CARBON FLM 1/16W 1.8K-Ω
R809	0700044M	RES.-CARBON FLM 1/16W 1.8K-Ω
R811	0110271S	RES.-MTL OXIDE FLM 2W 12K-Ω
R812	0110271S	RES.-MTL OXIDE FLM 2W 12K-Ω
R813	0110271S	RES.-MTL OXIDE FLM 2W 12K-Ω
R814	0113744M	RESISTOR CARBON FILM SRD1/2P-B 560-
R815	0113744M	RESISTOR CARBON FILM SRD1/2P-B 560-
R816	0113744M	RESISTOR CARBON FILM SRD1/2P-B 560-
R817	0700037M	RES.-CARBON FLM 1/16W 560-Ω
R818	0700037M	RES.-CARBON FLM 1/16W 560-Ω
R819	0700037M	RES.-CARBON FLM 1/16W 560-Ω
R820	0700045M	RES.-CARBON FLM 1/16W 2.2K-Ω
R821	0700046M	RES.-CARBON FLM 1/16W 2.7K-Ω
R822	0700046M	RES.-CARBON FLM 1/16W 2.7K-Ω
R823	0700046M	RES.-CARBON FLM 1/16W 2.7K-Ω
R824	0700046M	RES.-CARBON FLM 1/16W 2.7K-Ω
R850	0100041M	RES.-CARBON FLM 1/8W 100-Ω
R901	0147614X	RES.-WIRE WOUND 7W 1.5-K
R901A	0147616	RES.-WIRE WOUND 7W 1.8-K
R902	0113791M	RES.-CARBON FLM 1/2W 47K-Ω
R903	0113791M	RES.-CARBON FLM 1/2W 47K-Ω
R905	0100063M	RES.-CARBON FLM 1/8W 820-Ω
R908	0113701M	RESISTOR CARBON FILM SRD1/2P-B 10-Ω
R909	0194068F	RES.-WIRE WOUND 2W 1.0-KF
R910	0110275S	RES.-MTL OXIDE FLM 18K-Ω
R911	0700042M	RES.-CARBON FLM 1/16W 1.2K-Ω
R912	0700041M	RES.-CARBON FLM 1/16W 1.0K-Ω
R913	0700039M	RES.-CARBON FLM 1/16W 820-Ω
R914	0110135S	RES.-MTL OXIDE FLM 390-Ω
R915	0114165M	RESISTOR-CARBON FILM SRD 1/4 PF 1.5
R916	0700049M	RES.-CARBON FLM 1/16W 4.7K-Ω
R917	0700054M	RES.-CARBON FLM 1/16W 10K-Ω
R918	0700029M	RES.-CARBON FLM 1/16W 150-Ω
R919	0100077M	RES.-CARBON FLM 1/8W 3.3K-Ω
R920	0100121M	RES.-CARBON FLM 1/8W 220K-Ω
R921	0100123M	RES.-CARBON FLM 1/8W 270K-Ω
R922	0700054M	RES.-CARBON FLM 1/16W 10K-Ω
R923	0700049M	RES.-CARBON FLM 1/16W 4.7K-Ω
R924	0110275S	RES.-MTL OXIDE FLM 18K-Ω
R925	0113701M	RESISTOR CARBON FILM SRD1/2P-B 10-Ω
R926	0113797M	RES.-CARBON FLM 1/2W 82K-Ω
R930	0700014M	RES.-CARBON FLM 1/16W 10-Ω
R940	0110217M	RES.-MTL OXIDE FLM 68JB 2W
R950	0700028M	RES.-CARBON FLM 1/16W 120-JB
 R998	0174704G	RES.-METAL OXIDE 10M-J TYPE V R68
S1101	2632851	5KEY TACT SWITCH
 S901	2634731	POWER SWITCH TYPE 02-01HPO-SDD FA3
TH901	2341323	THERMISTOR 14 OHM
T721	2260221	HORIZONTAL DRIVE COIL
T722	2276081	H. DRIVE TRANS

PRODUCT SAFETY NOTE . Components marked with a  have special characteristics important to safety. Before replacing any of these components, read carefully the **PRODUCT SAFETY NOTICE** of this Service Manual. Don't degrade the safety of the receiver through improper servicing

SYMBOL NO.	PART NO.	DESCRIPTION
 T761	2437351	FBT TYPE HFL 1427M
 T901	2216331	SWITCHING TRANS (78VA)
U001	HJ00071	TUNER ET-675SN
VR202	0150265	RESISTOR-VARIABLE RV06 10K-B
VR601	0150109	RES.-VARIABLE RV6 200-B
VR701	0150114	RES.-VARIABLE RV6 10K-B
VR801	0150110	RES.-VARIABLE RV6 500-B
VR802	0150110	RES.-VARIABLE RV6 500-B
VR803	0150110	RES.-VARIABLE RV6 500-B
VR804	0150109	RES.-VARIABLE RV6 200-B
VR806	0150109	RES.-VARIABLE RV6 200-B
W10	9374697	WIRE UL 1015 CSATEW AWG 18 BLACK
W301	9374575	UL CSA 1007-24HP CODE GREEN
W301A	9374574	SOLDER COATED WIRE UL1007 CSATR64 A
W401	9374592	SOLDER COATED WIRE UL1007 CSATR64 A
W403	9374538	WIRE UL1015 CSATEW AWG18 BLACK
W450	9374575	UL CSA1007-24HP CODE GREEN
W701	9374575	UL CSA1007-24HP CODE GREEN
W702	9374575	UL CSA1007-24HP CODE GREEN
W801	9374575	UL CSA1007-24HP CODE GREEN
W901	9374575	UL CSA1007-24HP CODE GREEN
X1101	2792071	CERAMIC OSC CST4-00MGW
X501	2791505	CRYSTAL HC-491U 3.58MHZ
X504	2170043	OSCILLATOR 4.43MHZ
ZC710	9451104	VARNISH CLOTH TUBE 0.8X1.8 YELLOW
ZC710A	9451104	VARNISH CLOTH TUBE 0.8X1.8 YELLOW
ZD1001	2339819M	ZENER HZS3C3 TA
ZD1101	2339837M	ZENER HZS-5C1 TAPE
ZD201	2331849M	ZENER HZ12C3 (TA)
ZD501	2331795M	ZENER HZ-5 (B2 TAPE)
ZD503	2339869M	ZENER HZS9C3 TA
ZD601	2339827M	ZENER HZS4C1 TA
ZD610	2339231M	ZENER HZS30-1L TA
ZD611	2339231M	ZENER HZS30-1L TA
ZD701	2331817M	ZENER DIODE HZ-7 TAPE (C1)
ZD702	2339869M	ZENER HZS9C3 TA
ZD705	2339869M	ZENER HZS9C3 TA
ZD721	2339854M	ZENER HZS7B1 TA
 ZD751	2339222M	ZENER HZS27-2L
ZD753	2339867M	ZENER HZS-9-C1 TAPE (SI.200MA)
ZD754	2335991M	ZENER HZ-T33 (02 TP)
 ZD755	2339831M	ZENER HZS5 A1 TA
ZD801A	2331836M	ZENER DIODE HZ-11 TAPE (B3) SI.200MW
ZD810	2331797M	ZENER DIODE HZ-5 TAPE (C1)
ZD902	2331814M	ZENER DIODE HZ-7 TAPE (B1)
ZD903	2339921M	ZENER HZS20-1 TA
ZD904	2339847M	ZENER HZS6C1 TA
ZD905	2339231M	ZENER HZS30-1L TA
ZD906	2339231M	ZENER HZS30-1L TA
ZD907	2339851M	ZENER HZS7A1 TAPE (SI.200MA)
ZFB	9413926	SILICON RUBBER
ZIT	9413926	SILICON RUBBER

PRODUCT SAFETY NOTE : Components marked with a  have special characteristics important to safety. Before replacing any of these components, read carefully the **PRODUCT SAFETY NOTICE** of this Service Manual. Don't degrade the safety of the receiver through improper servicing

SYMBOL NO.	PART NO.	DESCRIPTION
ZI0TT	9413926	SILICON RUBBER (CPT 2090)
ZI1TT	9413926	SILICON RUBBER (CPT 2090)
Z1145	9451104	VARNISH CLOTH TUBE 0.8X1.8 YELLOW
Z202A	9451104	VARNISH CLOTH TUBE 0.8X1.8 YELLOW (CMT 2097, CMT 2077)
Z602	9451136	UL CSA TUBE NO. 8
Z7TT	2784342	CONDENSER COVER (CMT 2097, CPT 2090)
Z702	9451136	UL CSA TUBE NO. 8
Z801A	9451104	VARNISH CLOTH TUBE 0.8X1.8 YELLOW
Z900	9413926	SILICON RUBBER
Z901	9485158	HOT MELT (AX-1503C)
Z920	9413926	SILICON RUBBER
Z990	9413926	SILICON RUBBER
Z	9414017	SILICON COMPOUND (G-746)
#0103	3333921	EARTH SPRING (CMT 2097, CMT 2077-191)
#0104	3763751	SK BINDER (CMT 2097, CMT 2077-191)
#0135	9449506	SCOTCH TAPE NO. 29 19MM (CMT 2097, CMT 2077-191)
#0221	3763752	SK BINDER 200 (CMT 2097, CMT 2077-191)
E001	9449538	NITTO TAPE NO.5 W25 (BLACK) (CMT 2097, CMT 2077-191)
E0701	2788081	CRT EARTH WIRE 18 (CMT 2090, CMT 2077-191)
E701	2776242	CONVEGENCE FREE MAGNET (30.2) (CMT 2097, CMT 2077-191)
 U701	BY00611	DEFLECTION YOKE C90-20ST3 (CMT 2097, CMT 2077-191)
V1	DE00991	PICTURE TUBE A48QAD220X(S) (CMT 2077-191)
 V1	DE00992	PICTURE TUBE (A48QAD220X) (CMT 2097)
N01	4615641	WEDGE (CMT 2097, CMT 2077-191)
 L905	2276001A	DEGAUSING COIL 21" 4P CONN (CMT 2097, CMT 2077-191)
#0128	0649009	HOOK-30 (CMT 2097, CMT 2077-191)
#101	QD03141	FRAME ASSY CMT 2097
#102	QD02143	FRAME ASSY CMT 2077 (CMT 2077, CPT 2090)
#110	QD02732	FRONT FRAME CMT 2097
#111	PC01871	POWER BUTTON CMT 2097
#112	PC01881	CONTROL BUTTON 2097
#113	3332453	E60 KNOB SPRING
#114	NJ01571	CPT BRACKET C20-P760 AVR
#116	3487484	HITACHI BADGE 55G
#117	PH03741	R/C LENS CMT 2097
#118	PH03751	FILTER CMT 2097
#119	MS00221	SP NET CMT 2097
#120	NX01701	ADHESION PIECE 2097
#121	3874861	ADHESION BOS C21-888
#122	4519512	4 X 16 B TAPPING SCREW
#123	4159423	SCR NO 3 X 12 FL/FLT
#126	9485210	STYRENE MONOMOR
#150	QD00045	COVER ASS'Y 2097

PRODUCT SAFETY NOTE : Components marked with a  have special characteristics important to safety. Before replacing any of these components, read carefully the **PRODUCT SAFETY NOTICE** of this Service Manual. Don't degrade the safety of the receiver through improper servicing

SYMBOL NO.	PART NO.	DESCRIPTION
#151	3165045	BACK COVER ASS'Y 2097
#152	3875531	CORD HOLDER CT2043
#153	MS00031	HIMERON
#154	MS00032	HIMERON SHEET
#160	4518376	SCREW 6X25 TAPPING WITH WSR SAE
#161	8781450	SCREW-3*20 TAPPING
#162	3876121	FBT SUPPORT CMT 2195
#163	4519512	4X16 B TAPPING SCREW
#164	4519511	4X16 B TAPPING SCREW
#165	4519512	4X16 B TAPPING SCREW
#166	8815126	WASHER-4LOCKING
#167	4756502	SAA ANTENNA LABEL
#200	QL02403	RATING LABEL 2097-981R
#201	QL03504	RATING LABEL 2077-191
#202	QL03514	RATING LABEL CMT 2077-192
#203	QL03518	RATING LABEL 2077-192R
#204	QL03522	RATING LABEL CPT 2090-751
#300	QN01632	STICKER CMT 2077
A01	UX02491	CRT ASS'Y (20") L.G
A01L	LUX0249 A	CRT ASS'Y
A02	UX02492	CRT ASS (20") L.G SOUTH
A02L	LUX0249 B	CRT ASS'Y
A11	JT06021	CMT 2097-981R MAIN PWB ASS'Y
A11L	LJT0602 A	S2 MAIN PWB ASS (20")
A12	JT06022	CMT 2077-191 MAIN PWB ASS'Y
A12L	LJT0602 B	S2 MAIN PWB ASS (20")
A13	JT06023	CMT 2077-192R MAIN PWB ASS'Y
A13L	LJT0602 C	S2 MAIN PWB ASS (20")
A14	JT06024	CPT 2090-751 MAIN PWB ASS'Y
A14L	LJT0602 D	S2 MAIN PWB ASS (20")
E1	3731081	PURSE LOCK
E2	3731081	PURSE LOCK
E3	3731081	PURSE LOCK
E4	3731081	PURSE LOCK
E6	3731081	PURSE LOCK
E7	3744161	PURSE LOCK 25
E8T	3731081	PURSE LOCK
E9T	3731081	PURSE LOCK
N	3705233	CLAMP ANODE
N001	QT00115	DHHS WARNING LABEL (CMT 2097,CMT 2077-192/192R)
NA	UQ03701	CMT 2097-981 FINAL ASS'Y (CMT 2097)
RP401	0100089M	RES.-CARBON FLM 1/8W 10K-Ω
RP402	0100089M	RES.-CARBON FLM 1/8W 10K-Ω
SP401	2414964	SPEAKER 6.5*15 (SQUARE)
SP402	2414964	SPEAKER 6.5*15 (SQUARE)
WL	2976143	2P CONNECTOR WITH LEAD
WP401	9374731	WIRE UL1007 7/0.26 SN BLACK
WP402	9374731	WIRE UL1007 7/0.26 SN BLACK
WR	2976755	3P CONNECTOR WITH LEAD
ZP401	0544510	TERMINAL PIECE
ZP402	0544510	TERMINAL PIECE
Z1	9413945	SILICONE KE-1300 (WHITE)
Z2	9449598	NITTOH TAPE NO.188

PRODUCT SAFETY NOTE . Components marked with a  have special characteristics important to safety. Before replacing any of these components, read carefully the **PRODUCT SAFETY NOTICE** of this Service Manual. Don't degrade the safety of the receiver through improper servicing

SYMBOL NO.	PART NO.	DESCRIPTION
E001	2905241	ANT ADAPTOR
E003	2941311	MANGAN DRY BATTERY EVEREADY
E004	EP00001	SIEMENS ADAPTOR
N003	4914896	USER CAUTION SHEET
N1	QR07851	CMT 2097 (INSTRUCTION MANUAL) ENG ALABI RU
N1	QR07852	CMT 2097-982R OPERATION GUIDE
N1	QR07861	CMT 2077 (INSTRUCTION MANUAL) ENG ALABI RU
N1	QR07862	CMT 2077-193/194 OPERATION GUIDE
N1	QR07881	CPT 2090 (INSTRUCTION MANUAL) ENGLISH
N1	QR07882	CPT 2090-752 OPERATION GUIDE
U1001	2574101	R/C HAND SET CLE-898

S2 SOUND SUB PWB ASS PART LIST (CMT 2097)

SYMBOL NO.	PART NO.	DESCRIPTION
#4501	3707211	PLASTIC RIVET (BLACK)
B4501	JK00053	S2 SOUND SUB PWB
C4501	0800015R	CAP.-ELECTRO. 10UF 16V
C4502	0800048R	CAP.-ELECTRO. 100UF 16V
D4501	2338321M	DIODE 1SS270 (TA)
D4502	2338321M	DIODE 1SS270 (TA)
E4501	2997055	7P CONNECTOR TYPE TXC
E4502	9371901	SOLDER COATED ANNEALED COPPER WIRE
Q4501	2326873R	TRS. DTC144ES
Q4502	2327773M	TRS. 2SC3413
Q4503	2337773M	TRS. 2SC3413
Q4504	2337773M	TRS 2SC3413
R4501	0700054M	RES.-CARBON FLM 1/16W 10K-Ω
R4502	0700041M	RES -CARBON FLM 1/16W 1.0K-Ω
R4503	0700067M	RES.-CARBON FLM 1/16W 100K-Ω
R4504	0700059M	RES.-CARBON FLM 1/16W 27K-Ω
R4505	0700041M	RES.-CARBON FLM 1/16W 1.0K-Ω
R4506	0700033M	RES.-CARBON FLM 1/16W 270-Ω
R4507	0700033M	RES.-CARBON FLM 1/16W 270-Ω
R4508	0700041M	RES -CARBON FLM 1/16W 1.0K-Ω
R4509	0700027M	RES -CARBON FLM 1/16W 100-Ω
R4510	0700027M	RES.-CARBON FLM 1/16W 100-Ω

HITACHI

HITACHI LTD. TOKYO JAPAN
International Sales Division,
THE HITACHI ATAGO BLDG.
No. 15 -12 Nishi-Shinbashi, 2 - Chome,
Minato-Ku, Tokyo 105, Japan
Tel. Tokyo 3 32581111

HITACHI SALES EUROPA GmbH
Am Seestern 18,
40547 Düsseldorf,
Germany
Tel. 0211 5291 50

HITACHI SALES (HELLAS) S.A.
91, Falirou Street, 117-41 Athens,
Greece
Tel. 92 42-620-4

HITACHI HOME ELECTRONICS (EUROPE) Ltd.
Hitachi House, Station Road, Hayes,
Middlesex UB3 4DR,
England
Tel. 0181 849 2000

HITACHI SALES IBERICA, S.A.
Gran Via Carlos Tercero.101,1 -1
Barcelona 08028
Tel. 3- 330.86.52

HITACHI FRANCE (RADIO-T.V.-ELECTRO-MENAGER) S.A.
4, allée des Sorbiers,
Parc d'active de Chêne,
69671 BRON Cedex,
France
Tel. 72 14-29-70

HITACHI HOME ELECTRONICS NORDIC
Domnarvsgatan 29 Lunda, Box 62
S-163 91 Spanga,
Sweden
Tel. 08 621 8250

**Scan & PDF-Design: Schaltungsdienst
Lange oHG
Verlag technische Druckschriften**

**Zehrendorfer Straße 11
D-12277 Berlin**

<http://www.schaltungsdienst.com>