

HITACHI

SERVICE MANUAL

PAL/SECAM/NTSC



HITA-02912

N

No. 02001

CMT 2187	- 191
	- 192
	- 192R
CMT 2196	- 982
CMT 2198	- 191
	- 194
CPT 2199	- 752

S2 Chassis

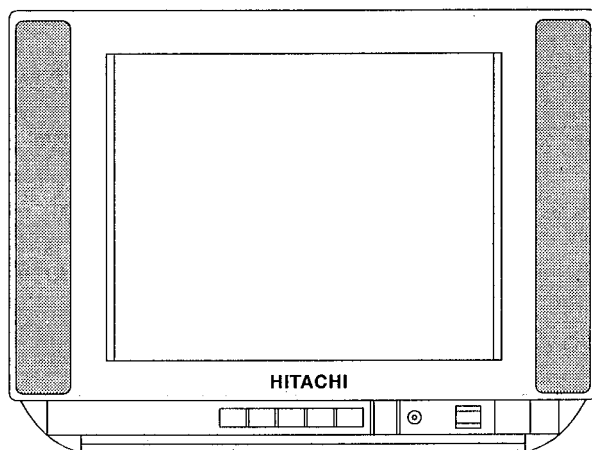

CAUTION : Before servicing this chassis, it is important that the service technician reads the "Safety Precaution" and "Product Safety Notices" in this Service Manual

CONTENTS

SAFETY PRECAUTIONS	2	ADJUSTMENT POINT	9
PRODUCT SAFETY NOTICE	2	TROUBLE SHOOTING	10
SPECIFICATIONS	3	WIRING DIAGRAM	12
CONTROLS	4	BASIC CIRCUIT DIAGRAM	14
REMOTE CONTROL UNIT	4	PRINTED WIRING BOARD	20
CIRCUIT DESCRIPTION	5	WAVEFORMS	21
AGC ADJUSTMENT	8	REPLACEMENT PARTS LIST	22
HORIZONTAL CENTER POSITION ADJUSTMENT	8		
VERTICAL AMPLITUDE ADJUSTMENT	9		

SPECIFICATIONS AND PARTS ARE SUBJECT TO CHANGE FOR IMPROVEMENT.

COLOR TELEVISION

February 1997 PT. HITACHI CONSUMER PRODUCTS INDONESIA

SAFETY PRECAUTIONS

WARNING: The following precautions should be observed.

1. Do not install, remove, or handle the picture tube in any manner unless shatter proof goggles are worn. People not so equipped should be kept away while picture tubes are handled. Keep the picture tube away from the body while handling.
2. When service is required, an isolation transformer should be inserted between power line and the receiver before any service is performed on the chassis.
3. When replacing the chassis in the cabinet, ensure all the protective devices are put back in place, such as barriers, non-metallic knobs, adjustment or compartment covers or shields, isolation resistors/capacitors, etc.
4. When service is Required, observe the original lead dressing. Extra precaution should be taken to assure correct lead dressing in the high voltage circuitry area. Particularly note the R.G.B. lead dressing. Ensure they are dressed well away from the horizontal scan and F.B.T. circuitry.
5. Always use the manufacturer's replacement component, always replace original spacers and maintain lead lengths. Especially critical components are indicated thus  on the parts list and should not be replaced by other makes. Furthermore, where a short circuit has occurred, replace those components that indicate evidence of overheating.
6. Before returning a serviced receiver to the customer, the service technician must thoroughly test the unit to be certain that it is completely safe to operate without danger of electrical shock, and be sure that no protective device built into the instrument by the manufacturer has become defective, or inadvertently damaged during servicing. Therefore, the following checks are recommended for the continued protection of the customers and service technicians.

INSULATION

Insulation resistance should not be less than 10MΩ at 500V DC between the mains poles and any accessible metal parts. Also, no flashover or breakdown should occur during the dielectric strength test, applying 3kV AC or 4. 25kV DC for two seconds between the main poles and accessible metal parts.

HIGH VOLTAGE

High voltage should always be kept at the rated value of the chassis and no higher. Operating at higher voltages may cause a failure of the picture tube or high voltage supply, and also, under certain circumstances could produce X-radiation moderately in excess of design levels. The high voltage must not, under any circumstances, exceed 28kV on the chassis.

X-RADIATION

TUBES: The primary source of X-radiation in this receiver is the picture tube. The tube utilised for the above mentioned function in this chassis is specially constructed to limit X-radiation.

For continued X-radiation protection, replace tube with the same type as the original HITACHI approved type.

PRODUCT SAFETY NOTICE

Many electrical and mechanical parts in HITACHI television receivers have special safety related characteristics. These characteristics are often not evident from visual inspection, nor can the protection afforded by them necessarily be obtained by using replacement components rated for higher voltage, wattage, etc. Replacement parts which have these special safety characteristics are identified by marking with a  on the schematics and replacement parts list in this Service Manual. The use of a substitute replacement component which does not have the same safety characteristics as the HITACHI recommended replacement one, shown in the parts list in this Service Manual, may create electrical shock, fire, X-radiation, or other hazards.

Product Safety is continuously under review, and new instructions are issued from time to time. For the latest information, always consult the current HITACHI Service Manual. A subscription to, or additional copies of HITACHI Service Manuals, may be obtained at a nominal charge from your HITACHI SALES CORPORATION.

TUBE DISCHARGE

The line output stage can develop voltages in excess of 25kV: if the E.H.T. cap is required to be removed, discharge the anode cap to chassis via a high value resistor, prior to its removal from the tube.

Specifications (CPT2199)

Reception system	625-lines: B. G PAL NTSC50-(VIDEO) 525-lines: NTSC3. 58-(VIDEO) NTSC4. 43 PAL60	Aerial input	75 Ω unbalanced type
		Color picture tube	A51JFC61XR/A51KPD12XX(S)
		Speaker	15 cm X 6.5 CM (X 2)
		Sound output (Max)	5 W X 2
		Power supply	AC 240V. 50Hz
Channel coverage (Frequency range 45MHz~294MHz 470MHz~863MHz)	Australia: AU 0~12 AU 28~69	Power consumption	89 W
		Weight (kg)	21.5
		Dimensions W X H X D (cm)	61.0 X 46.0 X 47.0

Specifications (CMT2198/CMT2196)

Reception system	625-lines: B. G/I/D K/H PAL B. G/D K/K SECAM NTSC50 525-lines: M/NTCS NTSC3. 58-5. 5/6. 0/6.5 NTSC4. 43-5. 5/6. 0/6.5 PAL60	Aerial input	75 Ω unbalanced type
		Color picture tube	A51JFC61XR/A51KPD12XX
		Speaker	15 cm X 6.5 CM (X 2)
		Sound output (Max)	5 W X 2
		Power supply	AC 110/127/220/230V, 50/60z
Channel coverage (Frequency range 45MHz~294MHz 470MHz~863MHz)	CCIR : E2~12, E21~69, S01~3 S1~10, S11~20 OIRT : R1~12, R21~69 JAPAN : J1~12, J13~62 U.S.A. : US2~13, J~W, US14~69 Hong Kong, U. K. : UK21~69 China : C1~12, C13~57	Power consumption	89 W
		Weight (kg)	21.5
		Dimensions W X H X D (cm)	61.0 X 46.0 X 47.0

Specifications (CMT2187)

Reception system	625-lines: B. G/I/D K/H PAL B. G/D K/K SECAM NTSC50 525-lines: NTCS3. 58-5. 5/6. 0/6.5 NTSC4. 43-5. 5/6. 0/6.5 PAL60	Aerial input	75 Ω unbalanced type
		Color picture tube	A51JFC61XR/A51KPD12XX
		Speaker	15 cm X 6.5 CM (X 2)
		Sound output (Max)	5 W X 2
		Power supply	AC 110/127/220/230V, 50/60z
Channel coverage (Frequency range 45MHz~294MHz 470MHz~863MHz)	CCIR : E2~12, E21~69, S01~3 S1~10, S11~20 OIRT : R1~12, R21~69 Hong Kong, U. K. : UK21~69 China : C1~12, C13~57	Power consumption	89 W
		Weight (kg)	21.5
		Dimensions W X H X D (cm)	61.0 X 46.0 X 47.0

★ Specifications are subject to change without notice to improve performance.

CONTROLS

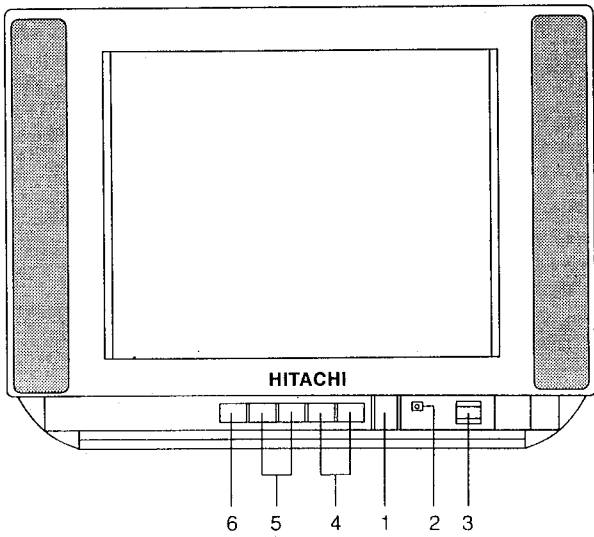

- 1 POWER switch
- 2 Remote control receiver
- 3 Power indicator (Stand-by)
- 4 Programme up/down

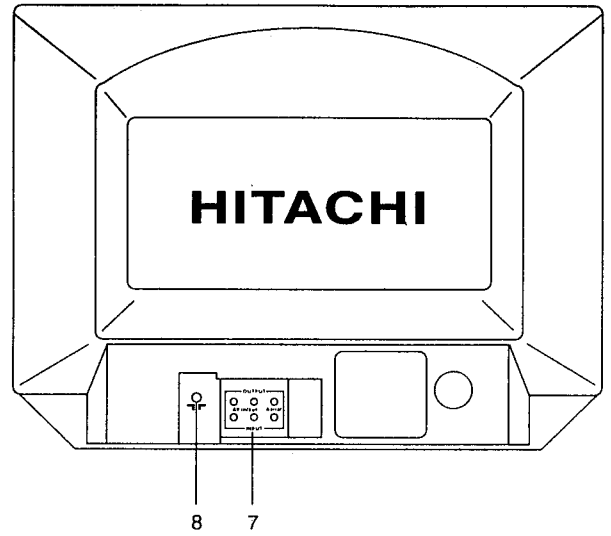

- 5 Volume up/down
- 6 TV/VIDEO selection
- 7 AV in/out terminals
- 8 Aerial input terminal

REMOTE CONTROL UNIT

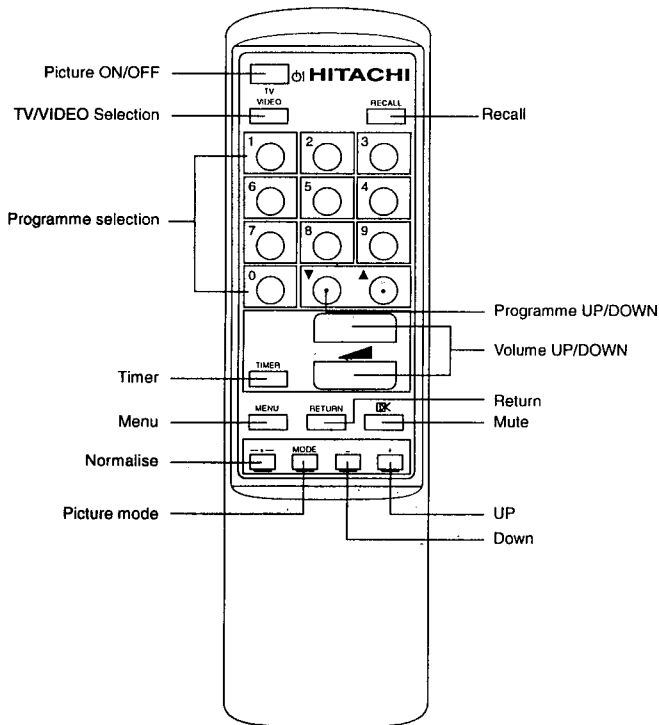

REMOTE CONTROL UNIT (CPT 2199 ONLY)

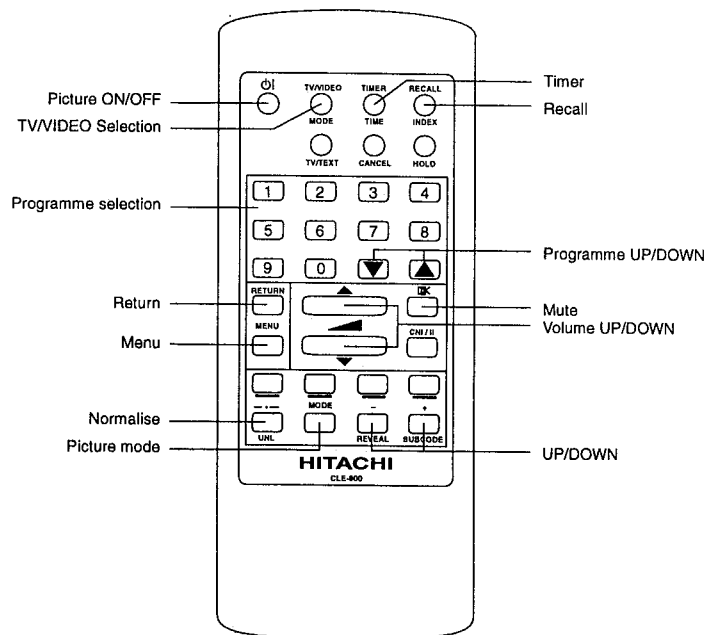

CIRCUIT DESCRIPTION

Tuner and I.F. Stages :

The tuner used on this chassis, is powered by the +9V, supply, and covers VHF, UHF, and CABLE.

The I.F. output from the tuner is applied to amplifier Q201 then selected with the mode shown in Table 1 and input to CP201 or CP202 (CMT2198/2196 ONLY).

Sound I.F. Stages : (CMT2198/2196/2187)

The sound stages consist of IC201, which is basically a demodulator, and IC402, which is the audio controller and IC4501, which is the output amplifier.

The I.F. signal at the collector of Q201, is fed via filter CP201, and input to IC201 at pins 45 and 46.

The composite signal output from pin 7 of IC201 is input to sound filters MF401*¹, MF402, MF403 and MF404, and selected with the mode shown in Table 1 at IC451 after being output from the filter. The selected signal is then input to pin 5 of IC201 via C422.

Demodulation is then performed by the IC, with the sound output being obtained from pin 1. This sound signal is controlled by IC402. It is then input to pins 2,5 of IC4501 via C408, C409 for further amplification, and output to the speaker from pins 7, 12.

Volume control is performed by the DC voltage applied to pin 5 of IC201. This is obtained via R427 from pin 8 of IC1101. Sound demodulation output at pin 1 of IC201, is applied to the terminal of rear via Q401 (CMT2187) or Q4502 at sound sub PWB (CMT2198/2196).

From the output terminal, the audio signal can be output to external equipment if desired.

Audio signals from external equipment can be applied to the input terminal of rear. They are then input to IC402 at pins 1 and 22. When connecting audio signals this way, a "Low" is applied to pin 4 of IC402 from IC1101, thereby changing the internal switching circuitry of the IC. Volume control of the external audio signal is then obtained in the same way as internal sound i.f. by the voltage at pin 5 of IC201.

B G/D K	M/I	Saw filter	Sound filter	Sound trap
H	H	CP202	MF401(4.5MHz)	MF503
L	H	CP201	MF402(5.5MHz)	MF501
H	L		MF403(6.0MHz)	MF502
L	L		MF404(6.5MHz)	

Table 1

Vision I.F. Stages :

The I.F. signal from CP201 and CP202 is input to pins 45 and 46 of IC201. These pins supply and internal amplifier consisting of three stages whose gain is controlled by the AGC circuit. The response speed of this internal AGC stage is determined by the external components connected to pin 48.

The output from the I.F. amplifier is then fed to the video detector circuitry. The picture carrier is limited and phase shifted by the tank circuitry of L202 etc., connected between pins 2 and 3 of the IC. This produces a reference frequency which is utilized for synchronous video detection.

An RF AGC voltage is made available at pin 48 of IC201, the starting level of which is determined by the voltage applied to pin 49, which in turn is fixed by the setting of VR202. This AGC voltage is then fed to the tuner via R208 to control its gain accordingly.

The composite video finally emerges at pin 7 of IC201.

Luminance Circuitry : (CMT2198/2196/2187)

The composite video signal output from pin 7 of IC201 is applied to the sound rejection filter MF501, MF502, and MF503*¹. MF501, MF502 and MF503*¹ are selected with the mode shown in Table I. The resulting luminance signal is applied to the terminal of rear, for output to external equipment if desired. It is then returned to pin 13 of IC201 via Q506, for color decoding and deflection synchronization.

The luminance signal is added internally to the R.G.B. matrix circuits of IC201, as well as being controlled by the brightness, contrast, and blanking stages of the IC.

The luminance signal finally emerges with the R.G.B. signals from pins 18, 19 and 20 of IC201.

The voltages to control the contrast and brightness levels are output from pins 3 and 4 of IC1101, then applied to pins 17 and 25 of IC201.

An automatic beam current circuit is employed on this chassis. Should the beam current start to rise, the voltage at pin 4 of the flyback transformer will fall. This fall is applied to the cathode of D758, then via R760 to pin 25 of IC201, thereby reducing the contrast level and hence the beam current.

Video inputs from external equipment connected to the terminal of rear, are fed to IC201 pin 15 via Q510.

When the external mode is selected, a "High" is applied to pin 16 of IC201.

Luminance Circuitry : (CPT2199)

The composite video signal output from pin 7 of IC201 is applied to the sound rejection filter MF503.

The resulting luminance signal is applied to the terminal of rear, for output to external equipment if desired.

It is then returned to pin 13 of IC201 via Q506, for color decoding and deflection synchronization.

The luminance signal is added internally to the R.G.B. matrix circuits of IC201, as well as being controlled by the brightness, contrast, and blanking stages of the IC.

The luminance signal finally emerges with the R.G.B. signals from pins 18, 19 and 20 of IC201.

The voltages to control the contrast and brightness levels are output from pins 3 and 4 of IC1101, then applied to pins 17 and 25 of IC201.

An automatic beam current circuit is employed on this chassis. Should the beam current start to rise, the voltage at pin 4 of the flyback transformer will fall. This fall is applied to the cathode of D758, then via R760 to pin 25 of IC201, thereby reducing the contrast level and hence the beam current.

Video inputs from external equipment connected to the terminal of rear, are fed to IC201 pin 15.

When the external mode is selected, a "High" is applied to pin 16 of IC201.

Chrominance Circuitry : (CMT2198/2196/2187)

IC201 is designed to demodulate PAL, NTSC and SECAM systems. And this IC can distinguish between PAL, NTSC or SECAM signals. The demodulated colour signals are output from IC201 pins 30 and 31 as the R-y and B-y signals, then fed to pins 14 and 16 of IC501 which is a switch capacitor delay line.

IC201 allows bi-directional communication between the SECAM decoder IC502 and automatic system manager for SECAM identification. It delivers the VCXO (voltage controlled xtal oscillator) reference frequency (4.43mhz only) to the SECAM decoder via pin 32 of IC201. Once

*1 ONLY FOR CMT2198/2196

SECAM is identified, the gated reference signal is outputted to pin 32 of IC201.

The inputs at pins 14 and 16 are clamped, then fed via a buffer stage to internal delay lines, which are driven by a clock signal of 3MHz to obtain a delay period of 640 Seconds. This internal clock is generated from a 6MHz voltage controlled oscillator, and line locked by the sandcastle pulse input at pin 5. Low pass filters after the delay line stages suppress the clock signals.

The undelayed and the delayed signals are then added, with the resulting R-y and B-y signals being output from pins 11 and 12 via an internal buffer stage.

These outputs are then fed to IC201 at pins 28 and 29. This IC contains clamping circuits, and a DC colour saturation control, the level of which is set by the voltage applied to pin 26 from pin 5 of IC1101. The signals are then applied to a MATRIX circuit, and finally emerge from pins 18, 19 and 20 as the blue, green, and red signals.

Chrominance Circuitry : (CPT2199)

IC201 is designed to demodulate PAL and NTSC systems.

And this IC can distinguish between PAL or NTSC signals.

The demodulated color signals are output from IC201 pins 30 and 31 as the R-y and B-y signals, then fed to pins 14 and 16 of IC501 which is a switch capacitor delay line.

The inputs at pins 14 and 16 of IC501 are clamped, then fed via a buffer stage to internal delay lines, which are driven by a clock signal of 3MHz to obtain a delay period of 640 Seconds. This internal clock is generated from a 6MHz voltage controlled oscillator, and line locked by the sandcastle pulse input at pin 5. Low pass filters after the delay line stages suppress the clock signals.

The undelayed and the delayed signals are then added, with the resulting R-y and B-y signals being output from pins 11 and 12 of IC501 via an internal buffer stage.

These outputs are then fed to IC201 at pins 28 and 29. This IC contains clamping circuits, and a DC color saturation control, the level of which is set by the voltage applied to pin 26 from pin 5 of IC1101. The signals are then applied to a MATRIX circuit, and finally emerge from pins 18, 19 and 20 as the blue, green, and red signals.

Deflection Circuits:

The deflection circuitry of IC201 contains a sync, separator stage, horizontal oscillator and output stages, a vertical count-down and output stage.

Horizontal Stage :

The composite video signal from pin 7 of IC201 is returned to pin 13 via C302 as explained previously. This input is applied to the internal sync, separator stages of the IC.

A internal phase detector stage is provided with will then compare this sawtooth waveform to the sync pulse. Any frequency drift will cause a corrective output to be applied to the horizontal oscillator, thereby maintaining the desired phase relationship.

The components connected to pin 40 form a filter network for the phase detector, and VR701/connected to pin 39 provides manual phase control. The horizontal

output emerges at pin 37 and is then applied to the base of line drive transistor Q721, T721 couples the output of Q721 to the line output transistor Q781. Both these transistors are powered by the 95V supply. A line pulse available at pin 6 of the flyback transformer is rectified by D751, smoothed by C756 and provides approximately 180V to drive the output transistors Q851, Q852, Q853.

Under certain fault conditions, i.e. increased H.T. supply, low line oscillator frequency, or reduced value of the tuning capacitor C781, an excess of E.H.T. could be developed. To prevent this happening, the rectified voltage of D751 is fed via potential divider R757, R758, and applied to ZD751. Should the E.H.T. rise excessively, the threshold of the zener will be exceeded, and a voltage will be applied to pin 35 of IC1101 via R1106, thereby shutting down the power circuit.

This effectively applies a "Low" to Q903 base, turning the transistor off. Consequently, Q902 will be turned off, and the +8V supply to IC201 is then removed, thereby shutting down the deflection stages of the IC, preventing further E.H.T. generation.

Excessive beam current can also occur under certain fault conditions, so this is prevented in the following manner.

The H.T. current to the horizontal output stages is measured by R781.

Should the current rise, the voltage drop across R781 will increase, and a voltage will be applied to the gate of Q901.

This will then prevent further E.H.T. generation as described earlier.

A supply of +25V is required for IC681. This is obtained from pin 1 of the flyback transformer, and smoothed by C754.

Vertical Stages :

The internal vertical sync. of IC201 is fed to a triggered vertical divider stage, which counts down the horizontal frequency to obtain the vertical frequency, thereby eliminating the need for a conventional oscillator circuit. This also has the advantage that no external frequency control is required.

C601 at pin 42 of the IC is used for ramp generation, and produces the required sawtooth output.

The vertical output from pin 43 of IC201 is applied to pin 4 of IC681 via R604. The components D601 and C605 determine the flyback generation time, and the vertical output to drive the deflection coils is made available from pin 2.

The deflection current that occurs at the junction of R609, is added to the feedback from R607/C608 etc. and the result is applied to pin 41 of IC201. The values of R607 and C608 determine the linearity, whilst VR601 sets the vertical height.

Power Supply Circuit :

AC input is rectified by D901-04 and produces approximately 300V to pin 3 of IC901.

Current flowing through R902-03, C905, causes power transistor in IC901 to initially turn on.

Secondary voltages are then induced in T901, and a feedback voltage is obtained via C910, R905 etc. and applied to pin 2 of IC901, thereby maintaining the transistors operation.

Secondary voltage in F1.F2 winding is rectified by D905 to produce H.T. of 95V which is smoothed by C914.

S1 – S2 winding produces 14V from D908, and this is smoothed by C916.

Pin 5 of IC901 is set to a pre-determined level by resistor network in IC901. Should the H.T. rise, pin 5 voltage of IC901 will become more positive, and this difference is amplified by transistor in IC901. An output is applied to drive transistor, and controls on time of power transistor. In this way, the H.T. is regulated and maintained at a constant level. D909 offers protection to the H.T. circuits should the voltage level rise excessively.

When the standby mode is selected, pins 21 and 22 of IC1101 will go "Low", removing the drive to Q903. As a result, Q902 is turned off, and voltage to pin 36 of IC201 disappears, therefore shutting down the deflection stages of the IC.

E.H.T generation will then cease for as long as the standby condition exist.

Remote Control and Tuning Circuitry :

The remote control receiving unit CP1201, contains an infrared amplifier type SPS409. This is powered by the +5V supply, which is stabilized by ZD1101. The output from pin 2 of this unit is applied to pin 16 of IC1101.

This IC type M37210M4, performs channel selection. UP/DOWN analogue control, an screen display, search tuning, and controls inputs and search tuning, and controls inputs and outputs to and from the AV terminal.

IC1102 is the memory IC, which stores the data relating to the above functions, then transfer that information to IC1101 when required. Both these ICs are powered by the +5V supply.

X1101 supplies IC1101 with a basic clock frequency which controls all operating mode requirements.

When the TV is first switched on , IC1101 must be initially reset, and this is achieved by IC1101 stages.

As the +5V supply begins to rise from switch on, pin 3 of Q1105 is held "Low". This is applied to pin 30 of IC1101 thus resetting the IC. Once pin 1 of Q1105 has almost reached its +5V potential, the "Low" is removed from pin 3 thus releasing the reset condition.

When the search routine has been initiated and a signal has been located, pin 14 of IC201 will become "High".

This is applied to pin 34 of IC1101, and informs the IC that a signal is present. The search routine then stops, and the IC will monitor the AFC signal present at pin 15 to obtain the optimum signal.

Pins 46 and 47 control the signal system.

Contrast, colour, brightness, sharpness, tint, and volume are all controlled from the remote control handset (the volume can also be adjusted by + and — buttons on the front of the TV), and will produce DC level changes from pins 3~8 of IC1101, which are then fed to the relevant pins of IC201.

Pins 31~32, 37~39, and 11 from the in and out matrix for the front control operations.

Pins 12 and 13 are the clock and data output pins. These signals are supplied to the memory IC1102.

It is supplied to pin 16 of IC201. When "High", the IC will process external inputs applied to pins 13 and 15, and when "Low", the internal signals are processed.

The handset button marked TV/VIDEO will need to be pressed. This will then produce the required "High" from pin 20 to achieve the necessary switching, as explained earlier.

The red, green and blue on-screen display signals are output from pins 50, 51 and 52. The components L1102, C1102, and C1103, on pins 28 and 29, determine the display oscillator frequency. The horizontal and vertical inputs at pins 1 and 2 determine the actual position of the on screen display.

When a command requiring an on-screen display is received by IC1101, a "High" will be output from pin 49.

This is applied to pin 21 of IC201, and blanks out a portion of the picture. The on-screen display information is then inserted into this portion, thus resulting in clear display. When the ALARM mode has been set, and the time input has elapsed, an output is obtained from pin 45 of IC1101.

This is then applied via R1184, R1119, C1111, R1118 etc. to pins 2 and 5 of IC4501 thus causing a "Bleep" sound to be heard.

Once the "Off" timer mode has been set, and the time input has elapsed, pins 21 and 22 of IC1101 output a "Low".

This removes the supply to the base of Q903, and as a result the +9V output of Q902 disappears. This places the TV into its standby mode of operation by removing E.H.T. generation as explained previously.

When the "ON" time has been estimated and set, the standby command must be transmitted by the handset, to place the TV into its standby mode. As an indication that the standby mode is only temporary, pin 20 of IC1101 is taken "High" and "Low" alternately, causing D1114 to flash on and off.

When the entered time has elapsed, the "Low" outputs from pins 21 and 22 of IC1101 are removed, and the TV will return to normal operation.

AGC ADJUSTMENT

ADJUSTMENT LOCATION VR202

Preparations for adjustment	Adjustment Procedure	Remarks
<p>1 With the signal received, apply heat run for more than two minutes to avoid the influence of circuit temperature drift.</p> <p>2 Connect the voltmeter of at least 100kΩ internal impedance to the AGC terminal of the tuner.</p>	<p>1 Received following channel and strength.</p> <p>CHANNEL : CCIR 5 STRENGTH : -47 dBm</p> <p>Adjust VR202 until the following voltage is reached.</p> <p>V1-(0.5v±0.2v) V1:the voltage without signal</p> <p>2</p>	

HORIZONTAL CENTER POSITION ADJUSTMENT

ADJUSTMENT LOCATION VR701

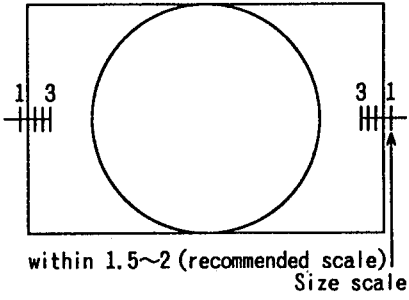
Preparations for adjustment	Adjustment Procedure	Remarks
<p>1 Receive the circle pattern signal.</p> <p>2 Set the brightness and contrast VRs to maximum.</p>	<p>1 Turn VR701 (H.Phase) and adjust so that size scales on the left and right are equal. (Refer to Fig. 3-2-1.)</p> <div style="text-align: center;">  <p>within 1.5~2 (recommended scale) Size scale</p> <p><u>Fig. 3-2-1</u></p> </div>	<p><u>Picture information amount</u> The amount of information means the amount of the transmitted picture that can be displayed on the CPT screen. It is necessary to increase this amount of information as much as possible and also decrease the lack of raster as far as possible.</p>

VERTICAL AMPLITUDE ADJUSTMENT

ADJUSTMENT LOCATION VR601

Preparations for adjustment		Adjustment Procedure			Remarks
1	Start adjustment 5 minutes or more after the power switch is turned on.	1	Select V.CENT select chip "u", "N" and "D" so that the center of the picture is closest to the geometrical center of the CPT.		
2	Receive the PAL circle pattern signal.	2	Adjust VR601 as shown in Fig. 3-3-1.		
3	Set the brightness and contrast VRs to maximum.	3	Receive the NTSC circle pattern signal and check that the picture is the same as that when a PAL signal is received.		
4	Place the set facing north or south.				

Picture condition		Top shrunk, bottom expanded	Standard condition	Top expanded, bottom shrunk
				
Adjustment method	Picture top	Center of inner and outer circles	Center of inner circle	
	Picture bottom		Inner circle	Center of inner and outer circles

Fig. 3-3-1

ADJUSTMENT POINT

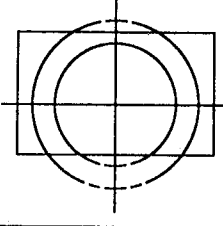
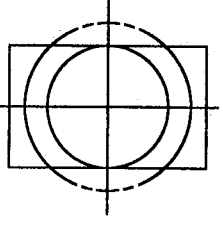
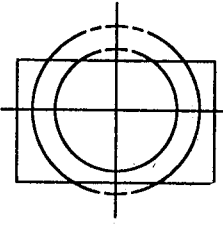
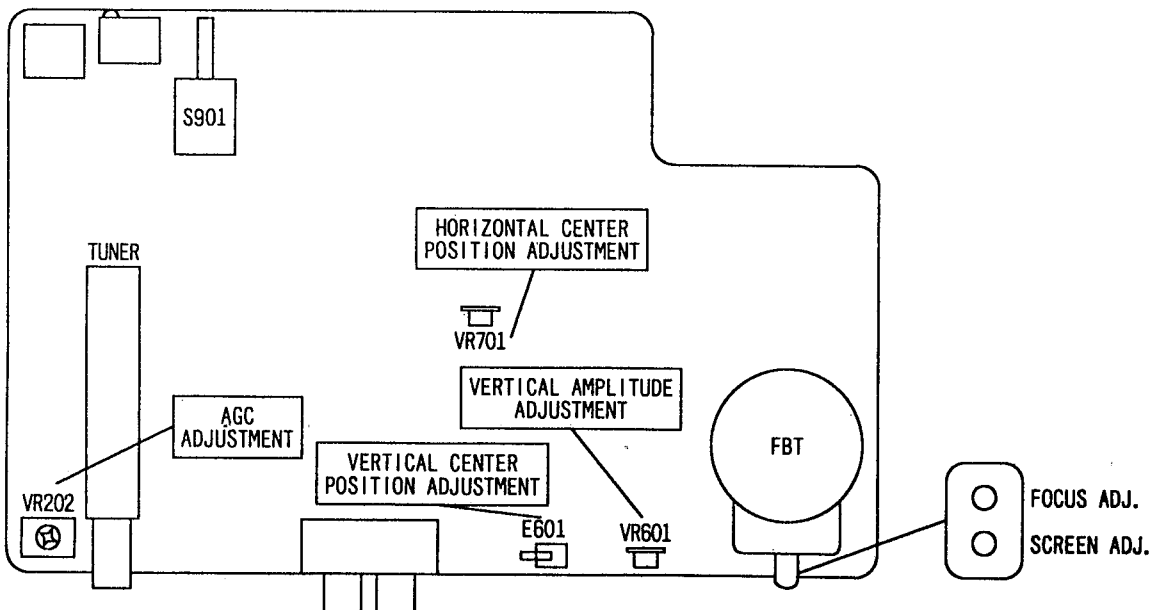

TROUBLE SHOOTING

No +B

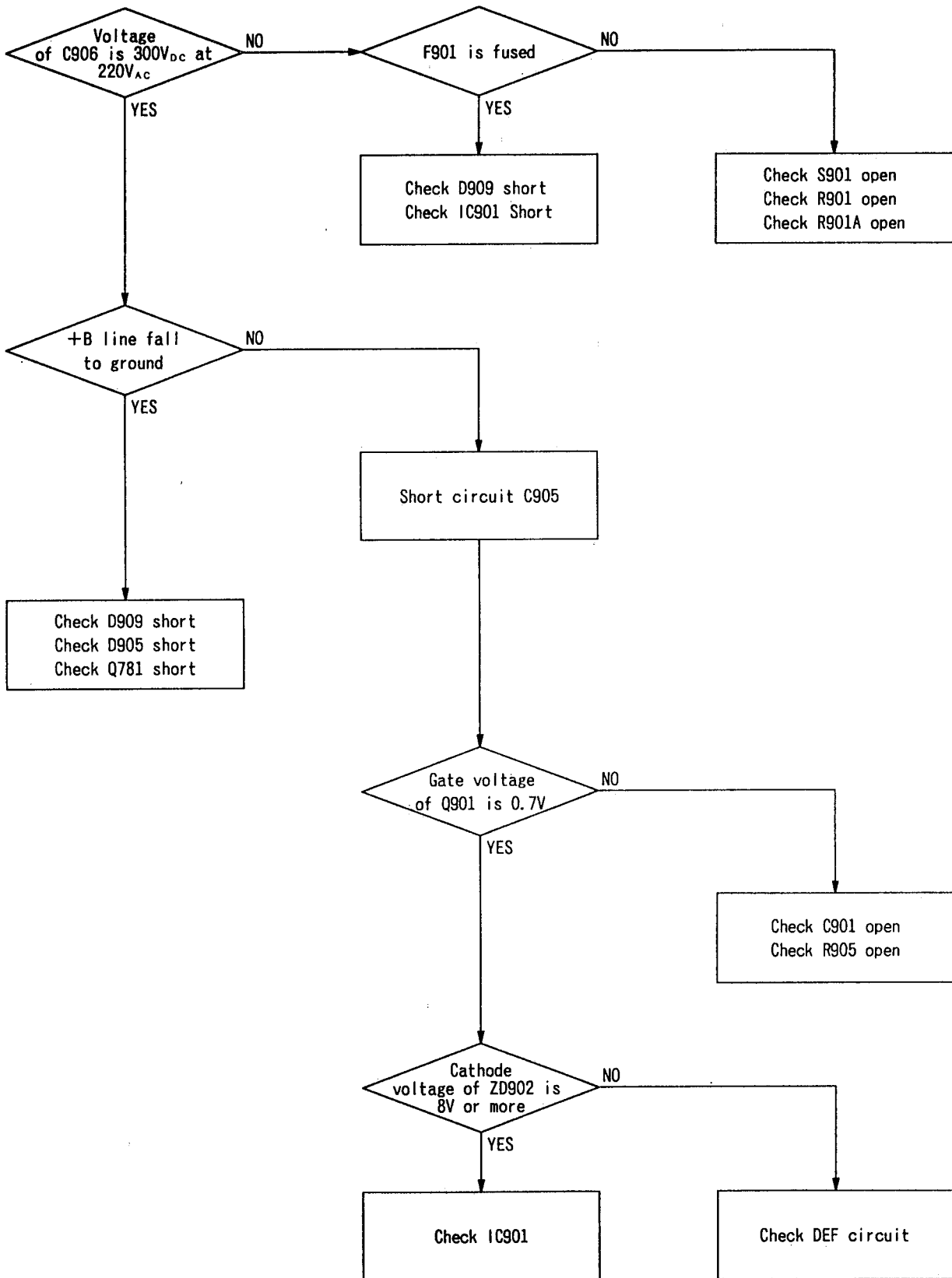

TV SET DOES NOT GO TO ON FROM STAND-BY MODE

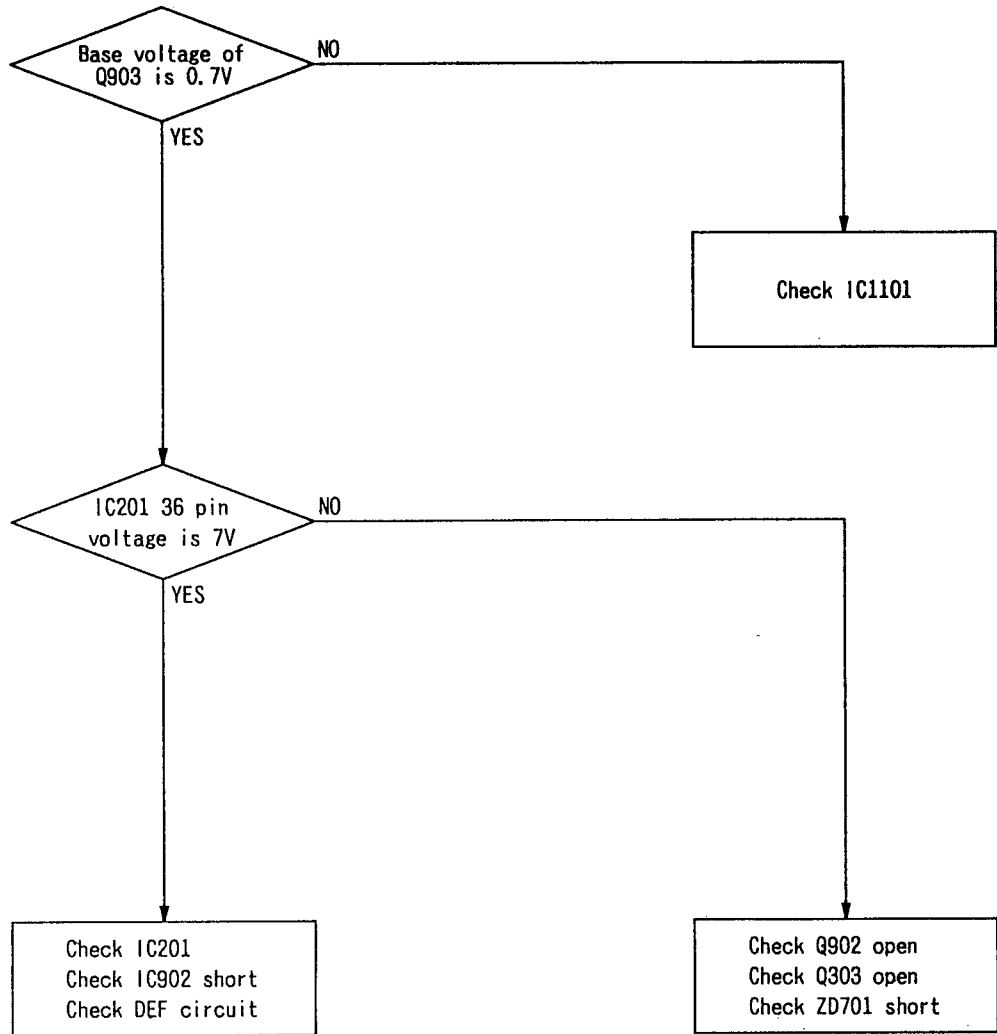

FINAL WIRING OF CMT 2198

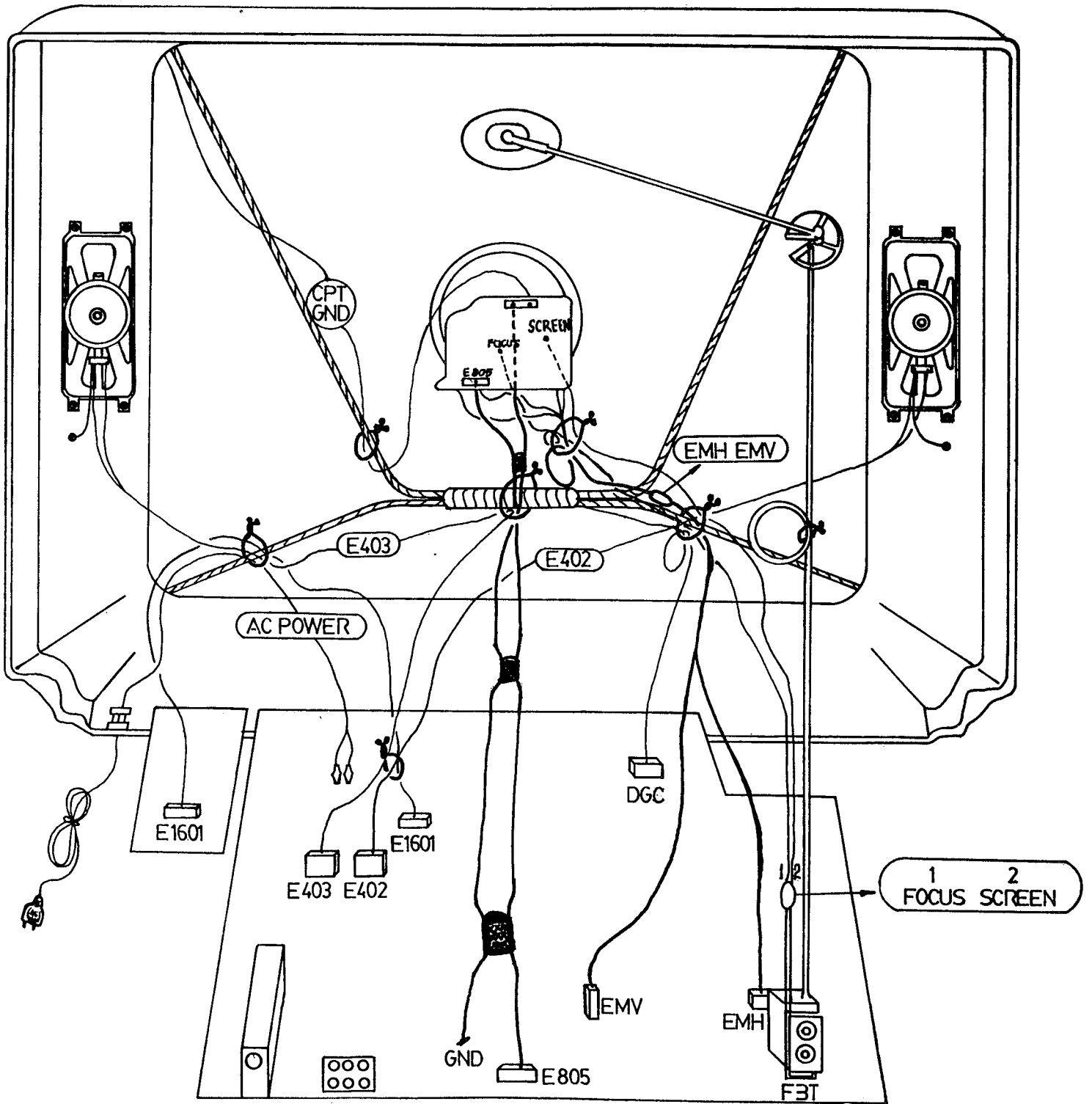

S2 A2 P.W.B. BASIC CIRCUIT DIAGRAM

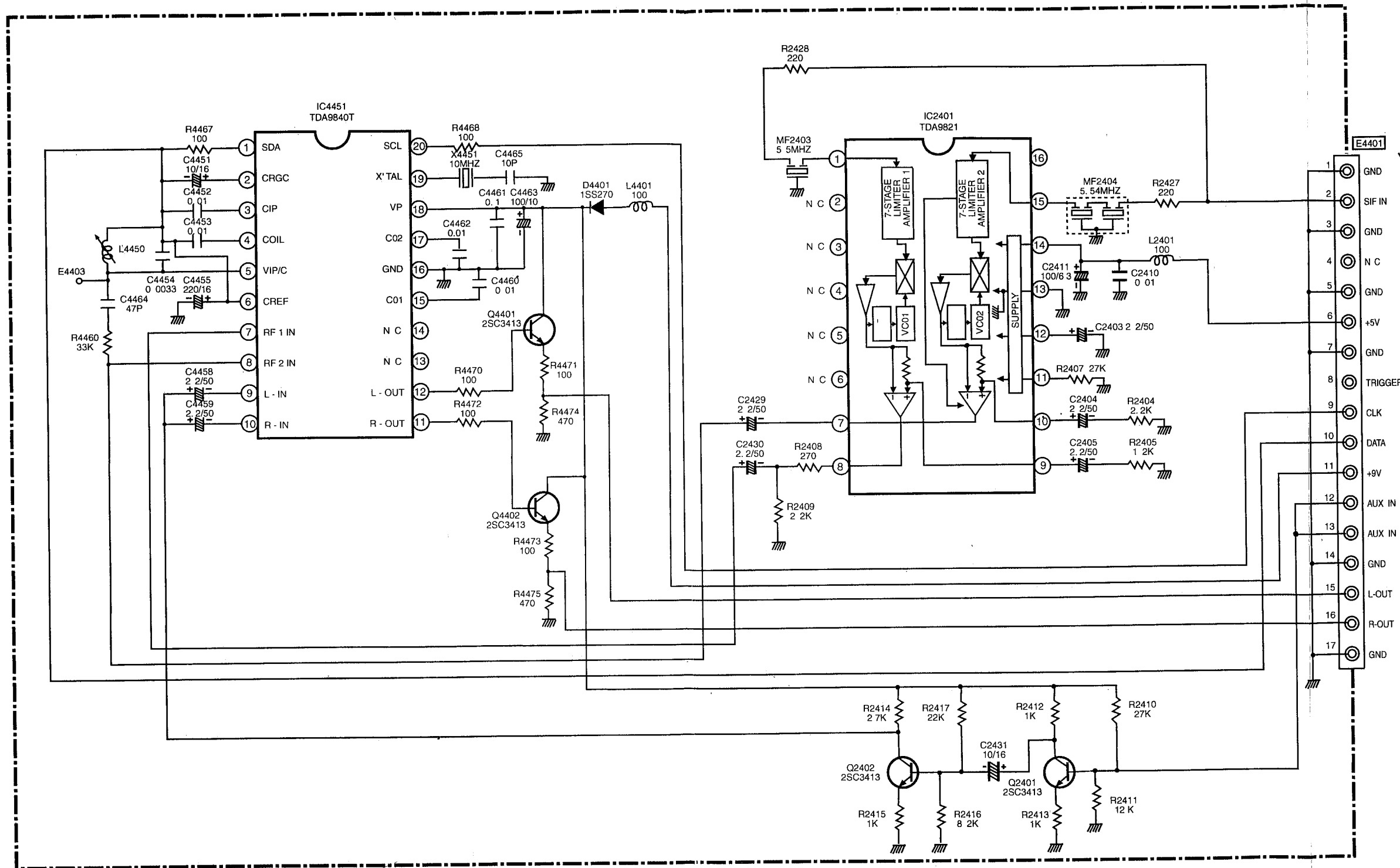

MIC ECHO P. W. B.

CMT 2198 ONLY

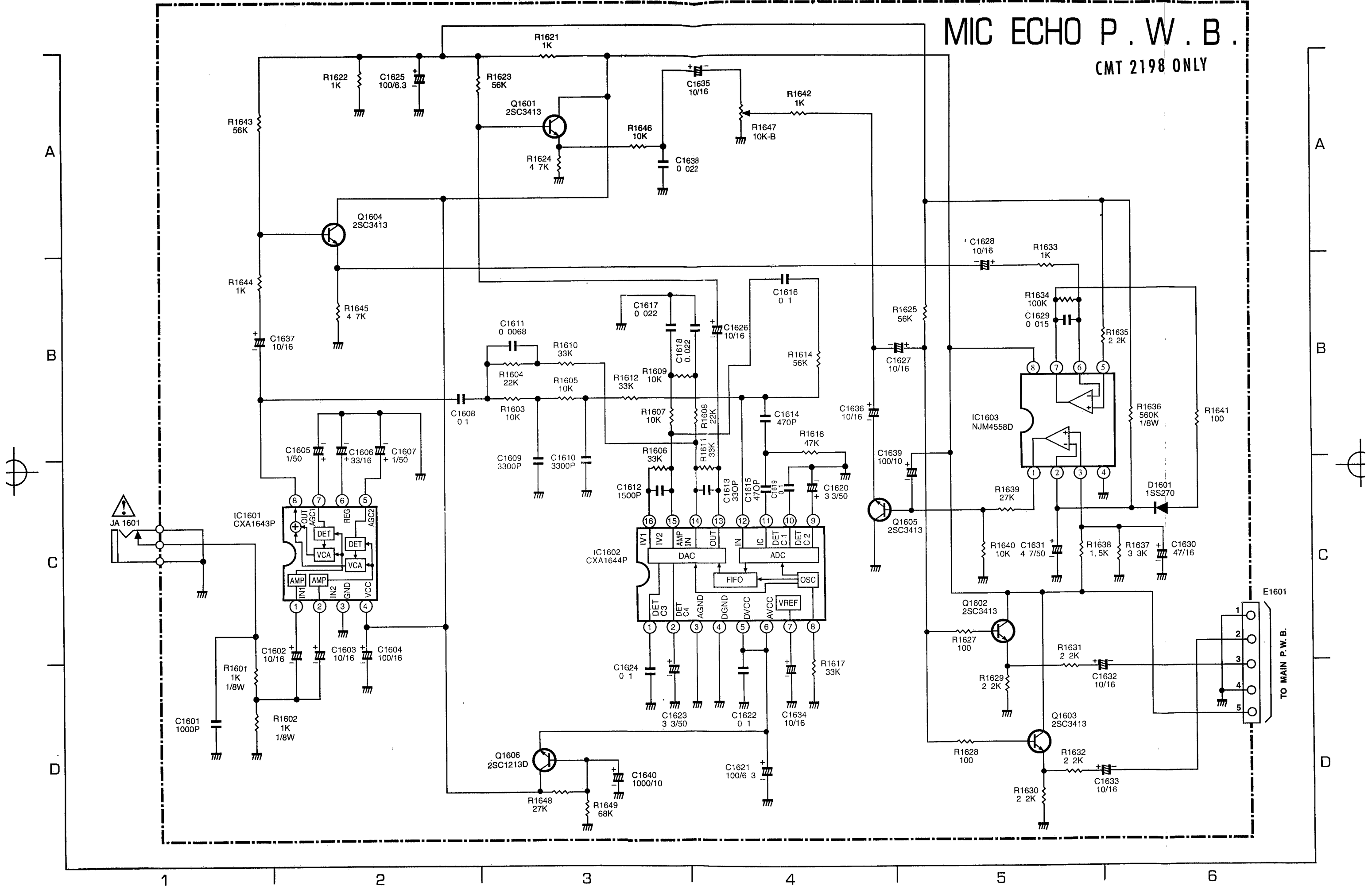

CMT 2187 BASIC CIRCUIT DIAGRAM

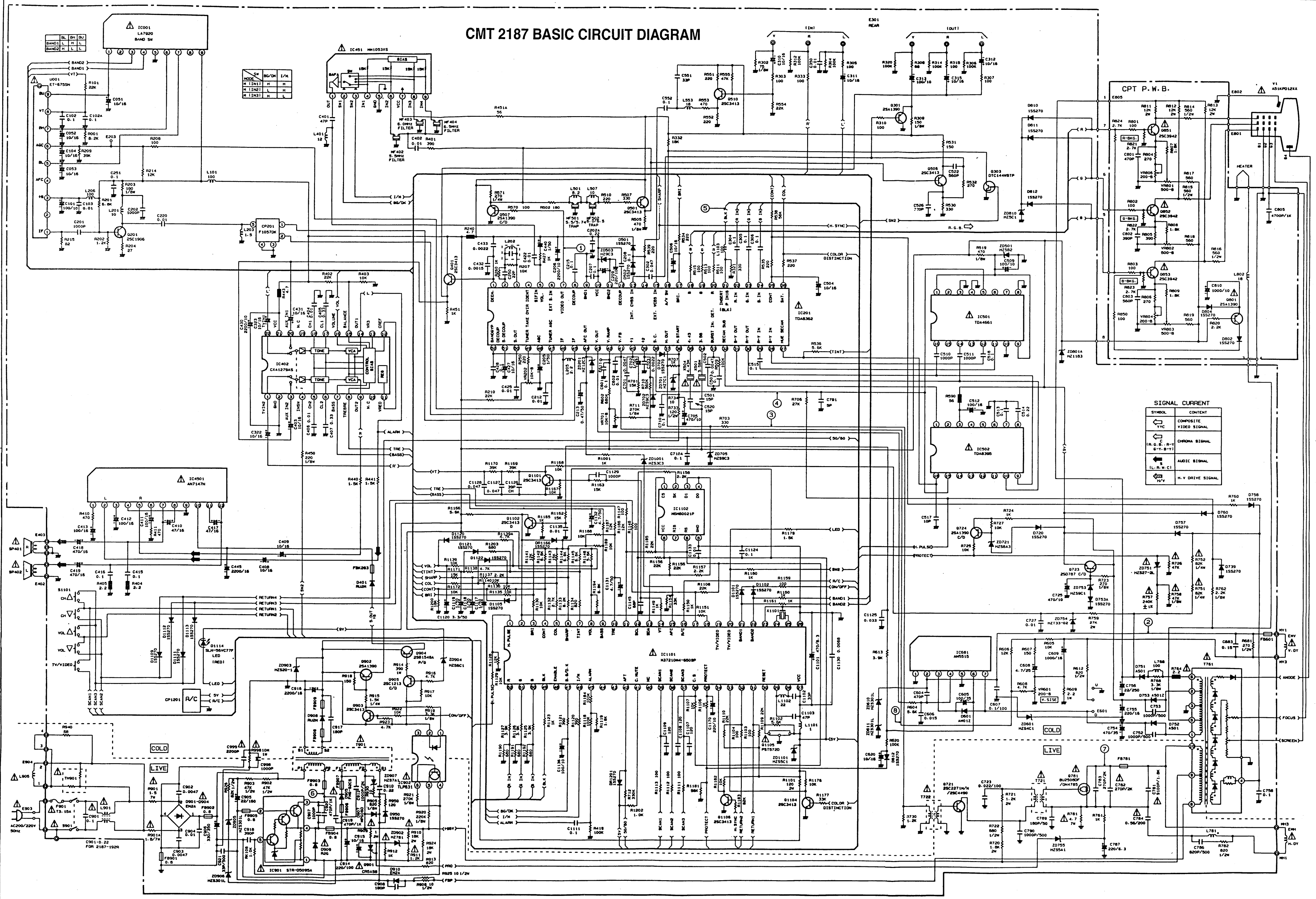

SIGNAL CURRENT

SYMBOL	CONTENT
\leftarrow V.C.	COMPOSITE VIDEO SIGNAL
\leftarrow R.G.B.	CHROMA SIGNAL
\leftarrow L.R.W.C.I.	AUDIC SIGNAL
\leftarrow H.V.	H.V. DRIVE SIGNAL

ABCDEFGHIJKLMNPQRSTUVWXYZ

abcdefghijklmnpqrstuvwxyz

CMT 2196 BASIC CIRCUIT DIAGRAM

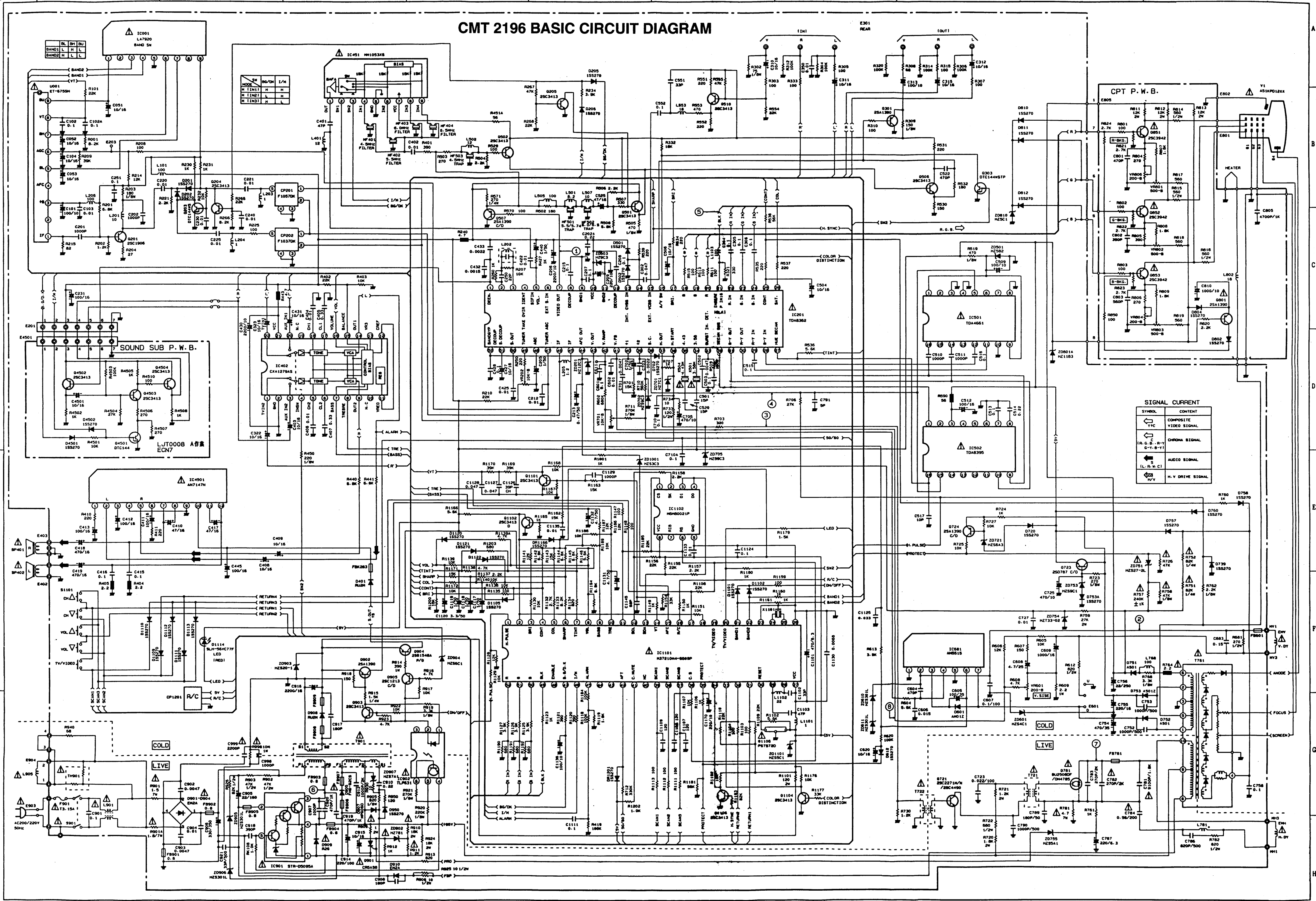

SIGNAL CURRENT

SYMBOL	CONTENT
\leftarrow Y/C	COMPOSITE VIDEO SIGNAL
\leftarrow R-G-B-Y	CHROMA SIGNAL
\leftarrow L-R-M-C	AUDIO SIGNAL
\leftarrow V/V	H.V. DRIVE SIGNAL

CMT 2198 BASIC CIRCUIT DIAGRAM

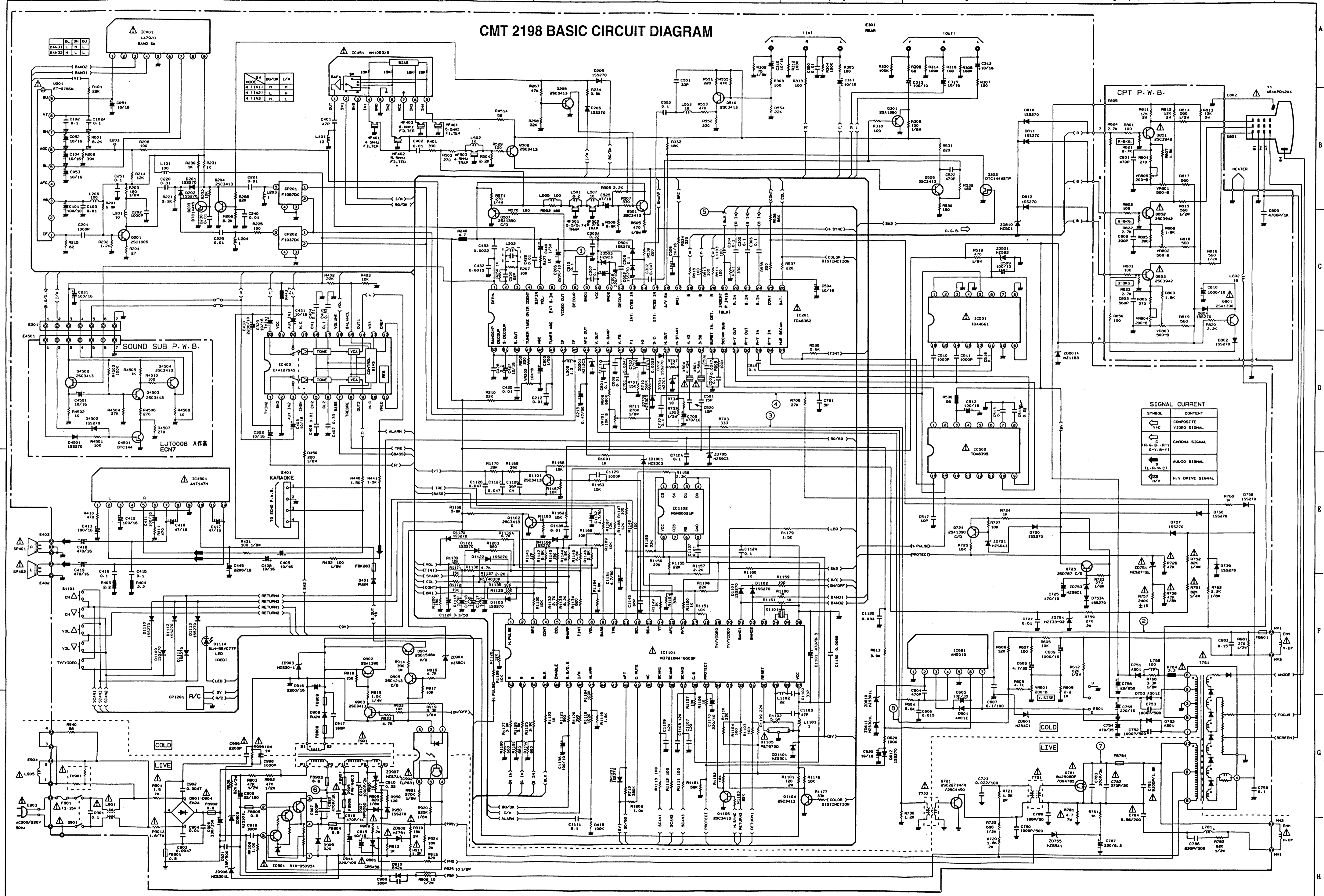

SIGNAL CURRENT

SYMBOL	CONTENT
\leftarrow Y/C	COMPOSITE VIDEO SIGNAL
\leftarrow R.G.B-Y	CHROMA SIGNAL
\leftarrow L.R.W.C	AUDIO SIGNAL
\leftarrow H.V	H.V DRIVE SIGNAL

ABCDEFGHIJKLMNPQRSTUVWXYZ

abcdefghijklmnpqrstuvwxy

100

18

αβγδεζηθικλμνξοπ

Since this is a basic circuit diagram, the value of the parts is subject to be altered for improvement.

MAIN P.W.B.

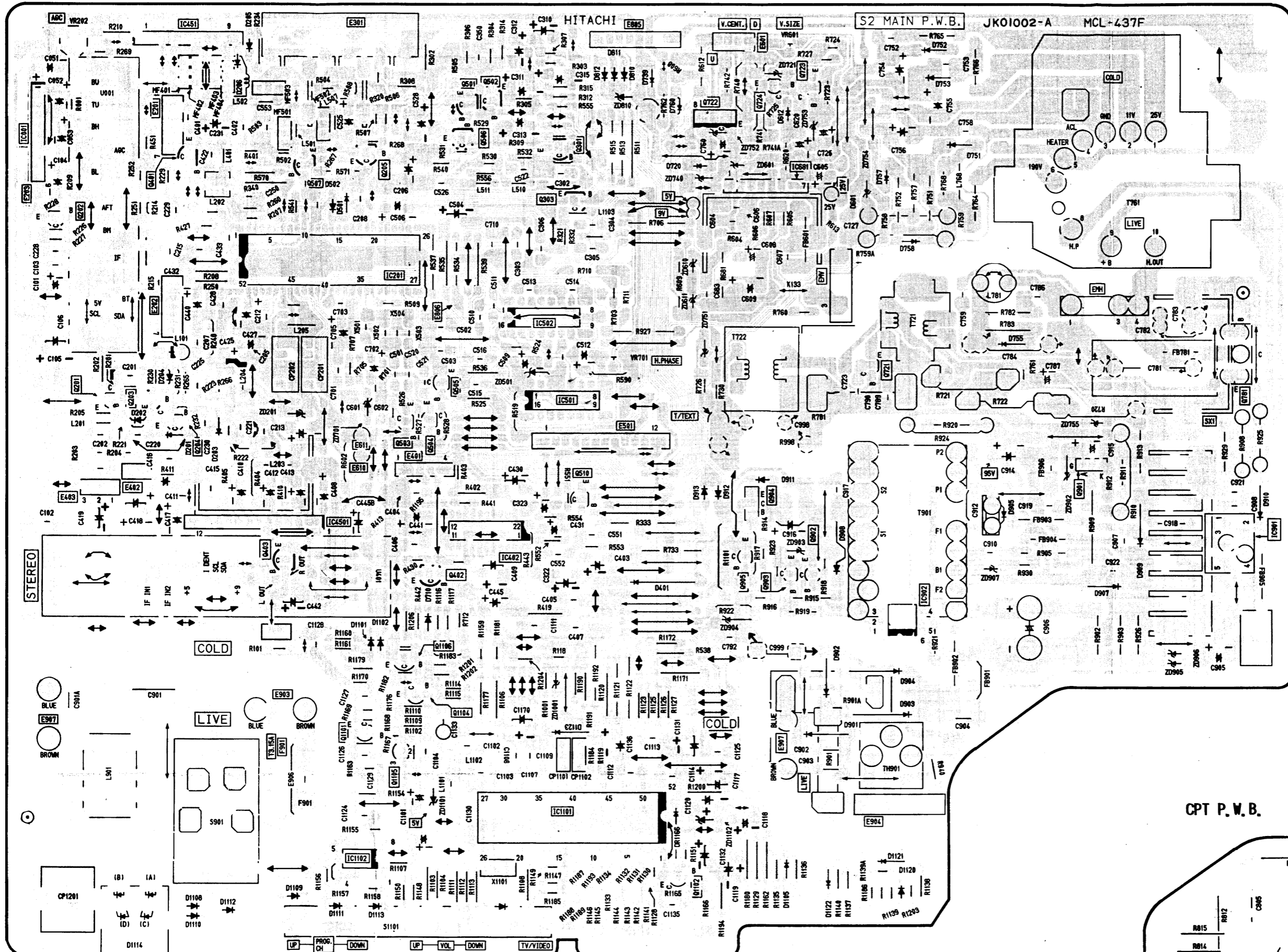

CPT P.W.B.

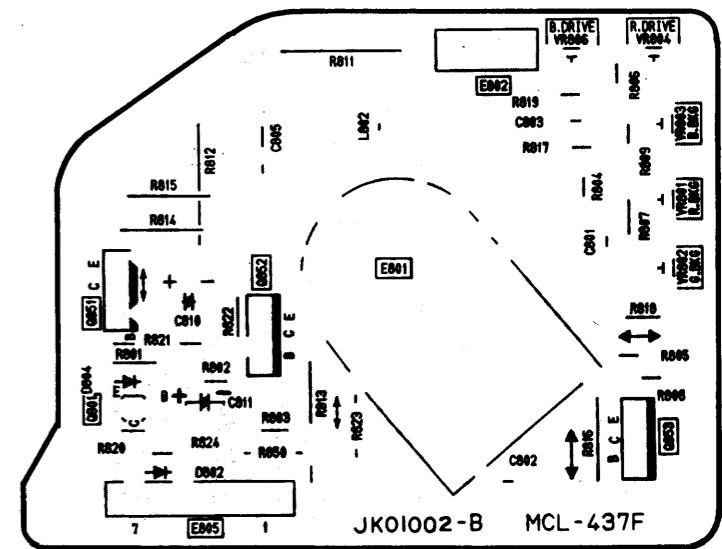

CPT 2199 BASIC CIRCUIT DIAGRAM

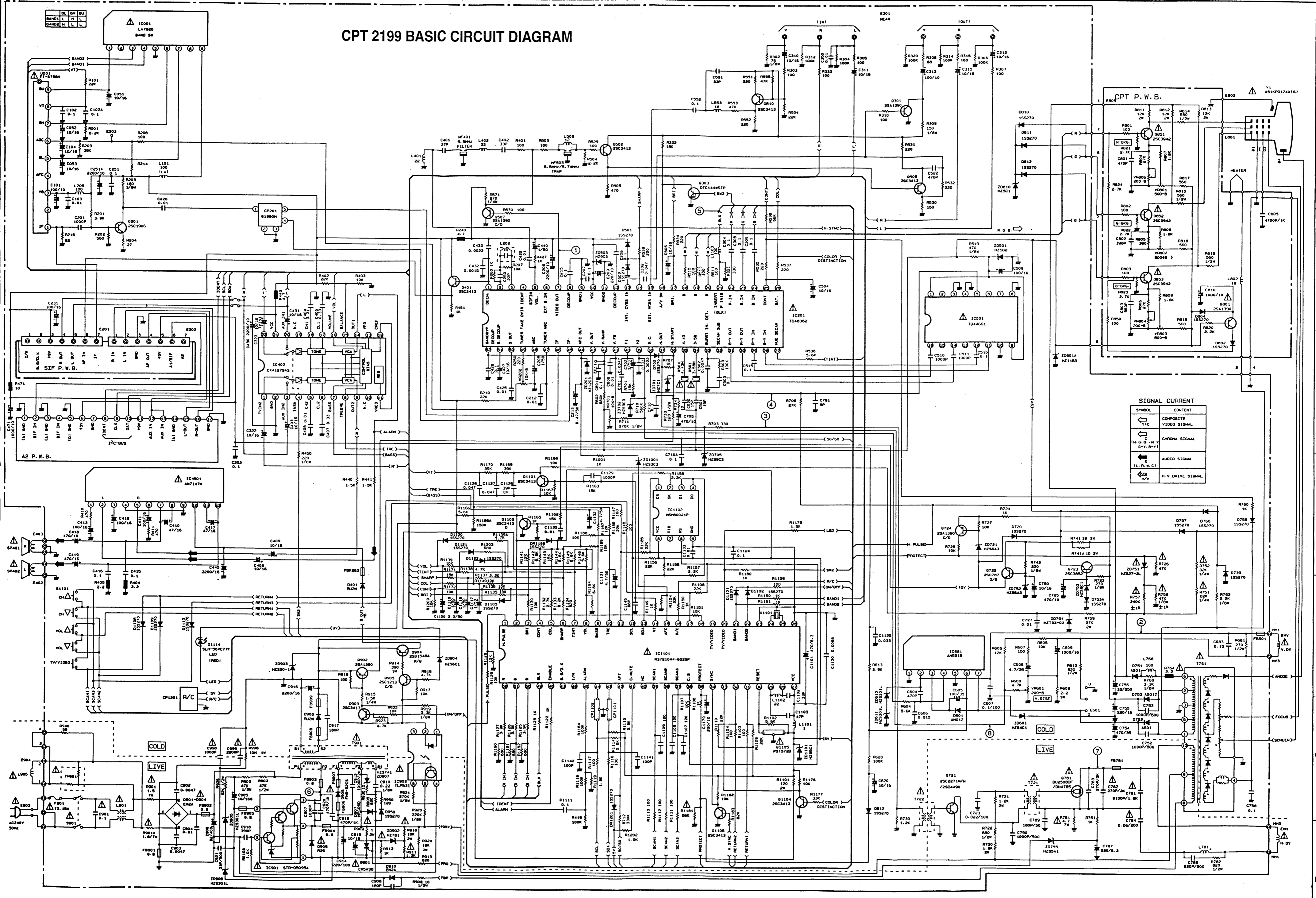

SIGNAL CURRENT

SYMBOL	CONTENT
\leftarrow Y/C	COMPOSITE VIDEO SIGNAL
\leftarrow C	CHROMA SIGNAL
\leftarrow R-Y, B-Y	B-Y, B-Y
\leftarrow S	AUDIO SIGNAL
\leftarrow H.V.	H.V. DRIVE SIGNAL

ABCDEFGHIJKLMNPQRSTUVWXYZ

abcdefghijklmnopqrstuvwxy

100

αβγδεζηθικλμνξοπ

• Since this is a basic circuit diagram, the value of the parts is subject to be altered for improvement.

WAVEFORMS

① IC201 ⑦ pin

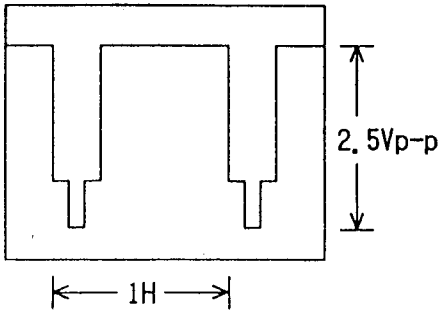

⑤ IC201 ⑳ pin

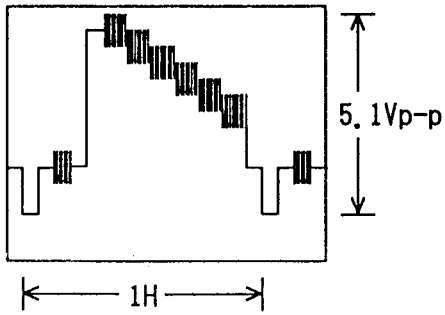

⑨ IC201 ⑳ pin

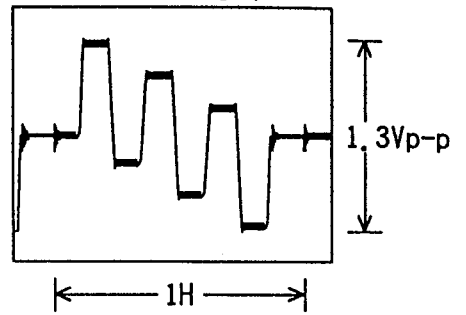

② V-DY

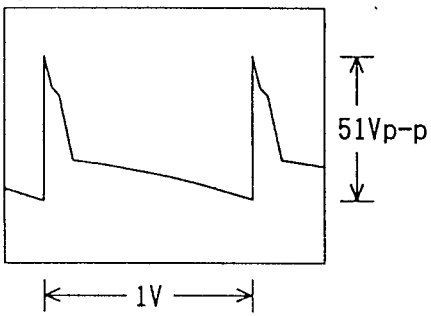

⑥ IC901 ③ pin

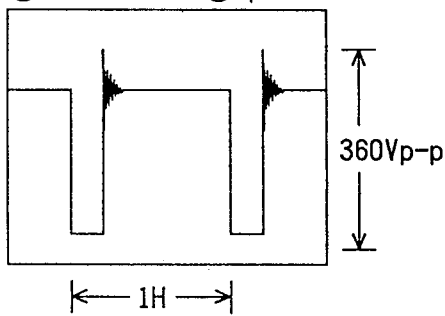

⑩ IC201 ⑳ pin

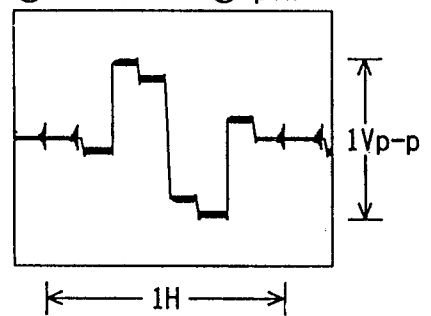

③ IC201 ⑳ pin

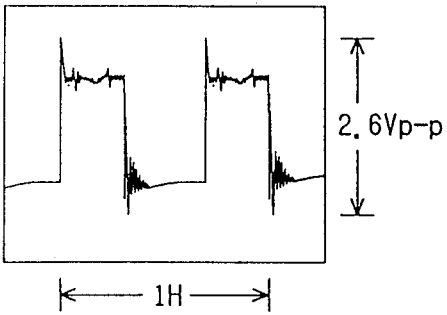

⑦ Q781 Collector

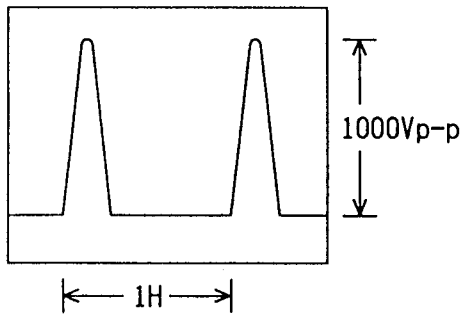

⑪ IC201 ⑳ pin NTSC/PAL

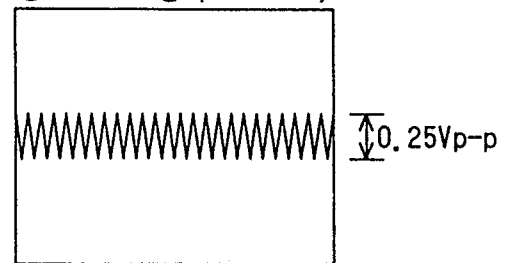

④ IC201 ⑳ pin

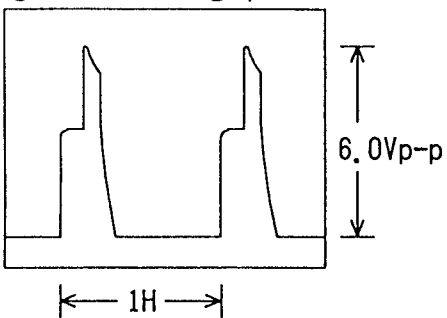

⑧ IC201 ④ pin

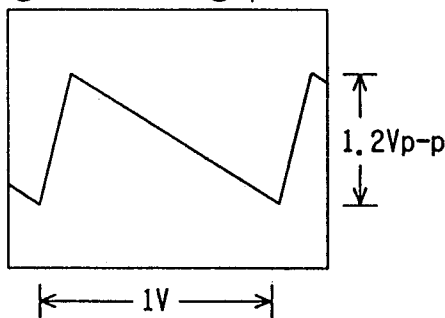

⑫ IC201 ⑳ pin SECAM

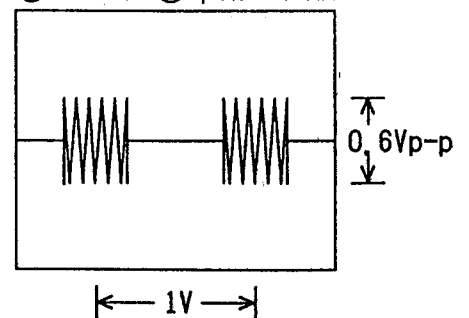

PRODUCT SAFETY NOTE: Components marked with a  have special characteristics important to safety. Before replacing any of these components, read carefully the **PRODUCT SAFETY NOTICE** of this Service Manual. Don't degrade the safety of the receiver through improper servicing.

SYMBOL NO.	PART NO.	DESCRIPTION
#0102	8821234	NUT-3
#0104	4269926	WASHER
#0106	4520883	3*12 SCREW WITH WASHER
#0112	3442421	HEAT SINK
#0114	4519506	3*8 B-TITE SCREW
#0150	3708104	G7-X4 A LED HOLDER
#0153	3701202	PWB HOLDER G7-A
#0155	3746073	IEC POWER CORD HOLDER
#0180	ME00111	INSULATOR S2
#0190	ME00121	PVC SHIELD PLATE S2
#0910	MA00031	HEAT SINK FOR IC901
#0912	4520883	3*12 SCREW WITH WASHER
#0914	4333705	HEAT SINK SO POWER
A11	JT05171	A2 SOUND PWB ASS 2199-751
A11L	LJT0517 A	A2 SOUND PWB ASS (CPT 2199)
A21	JT01914	SIF PWB ASS CPT2199-751
A21L	LJT0191 D	SIF PWB ASS (CPT 2199)
B001	JK01002	PRINTED WIRING BOARD
CP1101	2791754R	CONDENSER WITH 3 TERMINAL 100PF (CPT2199)
CP1102	2791754R	CONDENSER WITH 3 TERMINAL 100PF (CPT2199)
CP1201	2574762	R/C MODULE SPS-409-1K
CP201	BG00281	SAW FILTER G1980M (CPT2199)
CP201	2306121	SAW F1057DK (CMT 2198, CMT2196, CMT2187)
CP202	2306122	SAW F1037DK (CMT 2198, CMT 2196)
C051	0800015R	CAP.-ELECTRO. 10UF-M 16V
C052	0800015R	CAP.-ELECTRO. 10UF-M 16V
C053	0800015R	CAP.-ELECTRO. 10UF-M 16V
C101	0800048R	CAP.-ELECTRO. 100UF-M 10V
C102	0880016R	CAP.-POLYESTER FILM 0.1UF 50V
C102A	0880016R	CAP.-POLYESTER FILM 0.1UF 50V
C103	0880009R	CAP.-POLYESTER 0.01UF-K 50V
C104	0800015R	CAP.-ELECTRO. 10UF-M 16V
C1101	0800072R	CAP.-ELECTRO. 470UF-M 6.3V
C1102	0890067R	CAP.-CERAMIC 33PF-J 50V
C1103	0890069R	CAP.-CERAMIC 47PF-J 50V
C1107	0890075R	CAP.-CERAMIC 120PF-K 50V
C1108	0890075R	CAP.-CERAMIC 120PF-K 50V
C1109	0890075R	CAP.-CERAMIC 120PF-K 50V
C1111	0270734R	CAP.-MYL 0.1UF 50V
C1117	0800003R	CAP.-ELECTRO. 1.0UF-M 50V
C1118	0800003R	CAP.-ELECTRO. 1.0UF-M 50V
C1119	0800003R	CAP.-ELECTRO. 1.0UF-M 50V
C1120	0800007R	CAP.-ELECTRO. 3.3UF-M 50V
C1124	0880016R	CAP.-POLYESTER FILM 0.1UF 50V
C1125	0880013R	MYLAR CAPACITOR 0.033UF
C1126	0890122R	CAP.-CERAMIC 39PF-J 50V
C1127	0880014R	MYLAR CAPACITOR 0.047U
C1128	0880014R	MYLAR CAPACITOR 0.047U
C1129	0880003R	MYLAR CAPACITOR 0.001U
C1130	0880008R	MYLAR CAPACITOR 6800P
C1131	0800012R	CAP.-ELECTRO. 4.7UF-M 50V
C1132	0800012R	CAP.-ELECTRO. 4.7UF-M 50V
C1133	0880009R	CAP.-POLYESTER 0.01UF-K 50V
C1135	0880044R	CAP.-POLYESTER 0.01UF-KEB 50V
C1136	0800048R	CAP.-ELECTRO. 100UF-M 10V(CMT2198,CMT2196,CMT2187)







PRODUCT SAFETY NOTE: Components marked with a  have special characteristics important to safety. Before replacing any of these components, read carefully the **PRODUCT SAFETY NOTICE** of this Service Manual. Don't degrade the safety of the receiver through improper servicing.

C1141	0890074R	CAP.-CERAMIC 100PF-J 50V(CPT2199)
C1142	0890074R	CAP.-CERAMIC 100PF-J 50V(CPT2199)
C1145	0890072R	CAP.-CERAMIC 68PF-J 50V
C1170	0800057R	CAP.-ELECTRO. 220UF-M 10V
C201	0890087R	CAP.-CERAMIC 1000PF-K 50V
C202	0890087R	CAP.-CERAMIC 1000PF-K 50V(CMT2198,CMT2196,CMT2187)
C202A	0880062R	CAP.-POLYESTER 0.22UF-KEB 50V(CMT2198,CMT2196,CMT2187)
C205	0800003R	CAP.-ELECTRO. 1.0UF-M 50V
C206	0800366N	CAP.-ELECTRO. 2200UF-10V SMG
C207	0880016R	CAP.-POLYESTER FILM 0.1UF 50V
C208	0880016R	CAP.-POLYESTER FILM 0.1UF 50V
C209	0800057R	CAP.-ELECTRO. 220UF-M 10V
C212	0880009R	CAP.-POLYESTER 0.01UF-K 50V
C213	0800001R	CAP.-ELECTRO. 0.47UF-M 50V (SME)
C215	0880016R	CAP.-POLYESTER FILM 0.10UF 50V
C220	0880009R	CAP.-POLYESTER 0.01UF-K 50V
C221	0880009R	CAP.-POLYESTER 0.01UF-K 50V(CMT2198,CMT2196)
C225	0880009R	CAP.-POLYESTER 0.01UF-K 50V(CMT2198,CMT2196)
C230	0880009R	CAP.-POLYESTER 0.01UF-K 50V(CMT2198,CMT2196)
C231	0800049R	CAP.-ELECTRO. 100UF-M 16V(CPT2199,CMT2198,CMT2196)
C240	0880009R	CAP.-POLYESTER. 0.01UF-K 50V(CMT2198,CMT2196)
C250	0890118R	CAP.-CERAMIC 22PF-J CH 50V
C251	0880016R	CAP.-POLYESTER FILM 0.1UF 50V
C251A	0800366N	CAP.-ELECTRO. 2200UF-10V SMG
C252	0880016R	CAP.-POLYESTER FILM 0.1UF 50V(CPT2199)
C302	0880014R	MYLAR CAPACITOR 0.047U
C304	0880016R	CAP.-POLYESTER FILM 0.1UF 50V
C305	0880016R	CAP.-POLYESTER FILM 0.1UF 50V
C306	0880016R	CAP.-POLYESTER FILM 0.1UF 50V
C310	0800015R	CAP.-ELECTRO. 10UF-M 16V
C311	0800015R	CAP.-ELECTRO. 10UF-M 16V
C312	0800015R	CAP.-ELECTRO. 10UF-M 16V
C313	0800048R	CAP.-ELECTRO. 100UF-M 10V
C315	0800015R	CAP.-ELECTRO. 10UF-M 16V
C322	0800015R	CAP.-ELECTRO. 10UF-M 16V
C323	0800015R	CAP.-ELECTRO. 10UF-M 16V
C350	0880009R	CAP.-POLYESTER 0.01UF-K 50V
C401	0890066R	CAP.-CERAMIC 27PF-J 50V(CPT2199)
C401	0890069R	CAP.-CERAMIC 47PF-J 50V(CMT2198,CMT2196,CMT2187)
C402	0880009R	CAP.-POLYESTER 0.01UF-K 50V(CMT2198,CMT2196,CMT2187)
C402	0890067R	CAP.-CERAMIC 33PF-J 50V(CPT2199)
C403	0800015R	CAP.-ELECTRO. 10UF-M 16V
C404	0880009R	CAP.-POLYESTER 0.01UF-K 50V
C405	0270741R	CAP.-POLYESTER FILM 0.33UF 50V
C406	0880009R	CAP.-POLYESTER 0.01UF-K 50V
C407	0270741R	CAP.-POLYESTER FILM 0.33UF 50V
C408	0800015R	CAP.-ELECTRO. 10UF-M 16V
C409	0800015R	CAP.-ELECTRO. 10UF-M 16V
C410	0800041R	CAP.-ELECTRO. 47UF-M 16V
C411	0800049R	CAP.-ELECTRO. 100UF-M 16V
C412	0800049R	CAP.-ELECTRO. 100UF-M 16V
C413	0800049R	CAP.-ELECTRO. 100UF-M 16V
C415	0880016R	CAP.-POLYESTER FILM 0.1UF 50V
C416	0880016R	CAP.-POLYESTER FILM 0.1UF 50V
C417	0800041R	CAP.-ELECTRO. 47UF-M 16V
C418	0800074N	CAP.-ELECTRO. 470UF-M 16V
C419	0800074N	CAP.-ELECTRO. 470UF-M 16V
C422	0880009R	CAP.-POLYESTER 0.01UF-K 50V





PRODUCT SAFETY NOTE: Components marked with a  have special characteristics important to safety. Before replacing any of these components, read carefully the **PRODUCT SAFETY NOTICE** of this Service Manual. Don't degrade the safety of the receiver through improper servicing

C425	0880009R	CAP.-POLYESTER 0.01UF-K 50V
C427	0800015R	CAP.-ELECTRO. 10UF-M 16V
C428	0880016R	CAP.-POLYESTER FILM 0.1UF 50V
C430	0800366F	
C431	0800015R	CAP.-ELECTRO. 10UF-M 16V
C432	0880004R	MYLAR CAPACITOR 0.0015U
C433	0880005R	MYLAR CAPACITOR 0.0022U
C440	0284623R	CAP.-ELECTRO. 1UF-SME(BP) 50V
C445	0800049R	CAP.-ELECTRO. 100UF-M 16V(CMT2196)
C445	0800087	CAP.-ELECTRO. 2200UF-M 16V(CPT2199,CMT2198,CMT2187)
C471	0800081N	CAP.-ELECTRO. 1000UF-M 10V SME(CPT 2199)
C501	0890116R	CAP.-CERAMIC 15PF-J CH 50V
C502	0880007R	MYLAR CAPACITOR 0.0047UF 50V
C503	0880016R	CAP.-POLYESTER FILM 0.1UF 50V
C504	0800015R	CAP.-ELECTRO. 10UF-M 16V
C506	0800015R	CAP.-ELECTRO. 10UF-M 16V
C509	0800048R	CAP.-ELECTRO. 100UF-M 10V
C510	0890087R	CAP.-CERAMIC 1000PF-K 50V
C511	0890087R	CAP.-CERAMIC 1000PF-K 50V
C512	0800049R	CAP.-ELECTRO. 100UF-M 16V(CMT2198,CMT2196,CMT2187)
C513	0880016R	CAP.-POLYESTER FILM 0.1UF 50V(CMT2198,CMT2196,CMT2187)
C514	0880018R	CAP.-POLYESTER FILM 0.22UF-K 50V(CMT2198,CMT2196,CMT2187)
C515	0880016R	CAP.-POLYESTER FILM 0.1UF 50V
C516	0880016R	CAP.-POLYESTER FILM 0.1UF 50V
C517	0890061R	CAP.-CERAMIC 10PF- 50V(CMT2198,CMT2196,CMT2187)
C520	0890116R	CAP.-CERAMIC 15PF-J CH 50V
C522	0890083R	CAP.-CERAMIC 470PF-K 50V(CPT2199,CMT2198,CMT2196)
C522	0890084R	CAP.-CERAMIC 560PF-K 50V(CMT2187)
C525	0284667R	CAP.-ELECTRO. 47UF-MBPR(SME)16V(CMT2198,CMT2196)
C526	0890078R	CAP.-CERAMIC 220PF-K 50V(CMT2187)
C551	0890067R	CAP.-CERAMIC 33PF-J 50V
C552	0880016R	CAP.-POLYESTER FILM 0.1UF 50V
C601	0880016R	CAP.-POLYESTER FILM 0.1UF 50V
C602	0880044R	CAP.-POLYESTER 0.1UF-KEB 50V
C604	0249093R	CAPACITOR-CERAMIC 470PF-J SL 50WV
C605	0800052R	CAP.-ELECTRO. 100UF-M 35V
C606	0880011R	MYLAR CAPACITOR 0.015UF
C607	0279693	CAP.-POLY.FLM 0.1UF-K 100V
C608	0800009R	CAP.-ELECTRO. 4.7UF-M 25V
C609	0800082N	CAP.-ELECTRO 1000UF-MB16V(SME)
C620	0800015R	CAP.-ELECTRO. 10UF-M 16V
C683	0880017R	CAP.-POLYESTER 0.15MF-M 50V
C701	0880007R	MYLAR CAPACITOR 0.0047UF 50V
C702	0800003R	CAP.-ELECTRO. 1.0UF-M 50V
C703	0880005R	MYLAR CAPACITOR 0.0022U
C705	0800073R	CAP.-ELECTRO. 470UF-M 10V
C710	0880016R	CAP.-POLYESTER FILM 0.1UF 50V
C710A	0880016R	CAP.-POLYESTER FILM 0.1UF 50V
C723	0279851F	CAPACITOR-POLYESTER FILM 0.022UF-K
C725	0800352R	CAP.-ELECTRO.470UF 10V
C727	0880009R	CAP.-POLYESTER 0.01UF-K 50V
C752	0244501R	CAP.-CERAMIC 1000PF-K 500V
C753	0244501R	CAP.-CERAMIC 1000PF-K 500V
C754	0800076N	CAP.-ELECTRO 470UF-M 35V
C755	0800058R	CAP.-ELECTRO 220UF-M 16V
C756	0253973F	CAP.-ELECTRO 22UF-M 250V
C758	0880016R	CAP.-POLYESTER FILM 0.1UF 50V
C760	0600015R	CAP.-ELECTRO. 10UF-M 16V(CPT2199)





PRODUCT SAFETY NOTE: Components marked with a  have special characteristics important to safety. Before replacing any of these components, read carefully the **PRODUCT SAFETY NOTICE** of this Service Manual. Don't degrade the safety of the receiver through improper servicing

	C781	0262426F	CAP.-POLYESTER 0.0091UF 1.8KV
	C782	0244717	CAP.-CERAMIC 270P-K 2KV
	C783	0244717	CAP.-CERAMIC 270P-K 2KV
	C784	0262801F	CAP.-POLY.FLM 0.56UF-J 200V
	C786	0243512R	CAP.-CERAMIC 820PF-K 500V TAPE
	C787	0800056R	CAP.-ELECTRO. 220UF-M 6.3V
	C789	0890077R	CAP.-CERAMIC 180PF-K 50V
	C790	0244501R	CAP.-CERAMIC 1000PF-K 500V
	C791	0890055R	CAP.-CERAMIC 5PF 50V
	C801	0890083R	CAP.-CERAMIC 470PF-K 50V
	C802	0890082R	CAP.-CERAMIC 390PF-K 50V
	C803	0890084R	CAP.-CERAMIC 560PF-K 50V
	C805	0245612F	CAP.-CERAMIC 4700PF-KF B 1KV
	C810	0800359R	CAP.-ELECTRO. 1000UF-M 10V
	C901	0262773	CAP.-POLYPRO 0.1UF 250V(CPT2199,CMT2198,CMT2196,CMT2187)
	C901	0262774	CAP.-POLYPRO 0.22UF 250V(CMT2187-192R)
	C902	0248593F	CAP.-CERAMIC 4700PF-Z 250V
	C903	0248593F	CAP.-CERAMIC 4700PF-Z 250V
	C904	0248594F	CERAMIC CONDENSER (0.01 AC250 V)
	C905	0255506N	CAP.-ELECTRO. 10UF-M 160V (KME) (CPT2199)
	C905	0255507F	CAP.-ELECTRO. 22UF-MB 160V KME(CMT2198,CMT2196,CMT2187)
	C906	0259401F	CAP.-ELECTRO.82UF-MF 400V (CPT2199)
	C906	0284511	CAP.-ELECTRO. 330UF-M 350V(CMT2198,CMT2196,CMT2187)
	C907	0245608R	CAP.-CERAMIC 1000PF-K 1KV
	C908	0243504R	CAPACITOR-CERAMIC 180PF-K 500V
	C910	0880062R	CAP.-POLYESTER 0.22UF-KEB 50V
	C912	0244725	CAP.-CERAMIC 1000PF-K 2.0KV B
	C914	0258129F	CAP.-ELECTRO. 220UF-100V
	C915	0800015R	CAP.-ELECTRO. 10UF-M 16V
	C916	0800087F	CAP.-ELECTRO. 2200UF-M 16V
	C917	0243504R	CAPACITOR-CERAMIC 180PF-K 500V
	C918	0890029M	CAP.-CERAMIC 390PF-K B 50V
	C919	0245605R	CAP.-CERAMIC 470PF-K 1.0KV B
	C920	0245605F	CAP.-CERAMIC 470PF 100V
	C921	0247842R	CAP.-CERAMIC 33PF-SL 500V
	C998	0249498F	CAPACITOR CERAMIC(102PF---V)
	C999	0247974F	CAPACITOR CERAMIC(222PF---V)
	DR1166	2338321M	DIODE 1SS270 (TA)
	DR1201	2338321M	DIODE 1SS270 (TA)
	D1101	2338321M	DIODE 1SS270 (TA)
	D1102	2338321M	DIODE 1SS270 (TA)
	D1105	2338321M	DIODE 1SS270 (TA)
	D1108	2338321M	DIODE 1SS270 (TA) (CPT2199)
	D1109	2338321M	DIODE 1SS270 (TA)
	D1110	2338321M	DIODE 1SS270 (TA) (CMT2198,CMT2196)
	D1111	2338321M	DIODE 1SS270 (TA) (CMT2198,CMT2196,CMT2187)
	D1112	2338321M	DIODE 1SS270 (TA) (CMT2198,CMT2196,CMT2187)
	D1113	2338321M	DIODE 1SS270 (TA)
	D1114	2339691	LED SLH-56VC77F (RED)
	D1120	2338321M	DIODE 1SS270 (TA)
	D1121	2338321M	DIODE 1SS270 (TA)
	D1122	2338321M	DIODE 1SS270 (TA)
	D201	2338321M	DIODE 1SS270 (TA) (CMT2198,CMT2196)
	D202	2338321M	DIODE 1SS270 (TA) (CMT2198,CMT2196)
	D205	2338321M	DIODE 1SS270 (TA) (CMT2198,CMT2196)
	D206	2338321M	DIODE 1SS270 (TA) (CMT2198,CMT2196)
	D401	2333001	DIODE RUZM
	D501	2338321M	DIODE 1SS270 (TA)

PRODUCT SAFETY NOTE: Components marked with a  have special characteristics important to safety. Before replacing any of these components, read carefully the **PRODUCT SAFETY NOTICE** of this Service Manual. Don't degrade the safety of the receiver through improper servicing

D502	2338321M	DIODE 1SS270 (TA)
D601	2339491M	DIODE AM01Z (200 TAPE)
D612	2338321M	DIODE 1SS270 (TA)
D702	2338321M	DIODE 1SS270 (TA)
D720	2338321M	DIODE 1SS270 (TA)
D739	2338321M	DIODE 1SS270 (TA)
D751	2339482M	DIODE AS01 (400 TAPE)
D752	2339482M	DIODE AS01 (400 TAPE)
D753	2339481M	DIODE AS01Z (200 TAPE)
D753A	2338321M	DIODE 1SS270 (TA)
D757	2338321M	DIODE 1SS270 (TA)
D758	2338321M	DIODE 1SS270 (TA)
D760	2338321M	DIODE 1SS270 (TA)
D802	2338321M	DIODE 1SS270 (TA)
D804	2338321M	DIODE 1SS270 (TA)
D810	2338321M	DIODE 1SS270 (TA)
D811	2338321M	DIODE 1SS270 (TA)
D812	2338321M	DIODE 1SS270 (TA)
D901	2342711M	DIODE EM2A TAPE
D902	2342711M	DIODE EM2A TAPE
D903	2342711M	DIODE EM2A TAPE
D904	2342711M	DIODE EM2A TAPE
D905	2349971	DIODE FMG-G2CS
D907	2343961M	DIODE MPG06D G23 TA
D908	2333001	DIODE RU2M
D909	2342861M	DIODE R2G
D910	2342711M	DIODE EM2A TAPE
D950	2338321M	DIODE 1SS270 (TA)
EMH	2665279	4P PLUG PIN
EMV	2663132	3P PLUG PIN WITH BASE
E201	2997075	CONNECTOR PIN TXT-P07P-A1
E202	2997075	CONNECTOR PIN TXT-P07P-A1 (CPT2199)
E203	2122652M	FERRITE CORE
E301	2695261	6P JACK
E401	2902263	PLUG PIN SUB MINI 4P (CMT2198)
E402	2902261	PLUG PIN SUB MINI 2P
E403	2902262	PLUG PIN SUB MINI 3P
E601	2611331	3P SWITCH
E611	2122652M	FERRITE CORE
 E801	2698352	CPT SOCKET
E802	2661751	2P PLUG PIN WITH BASE
E805	2995604	8P CONNECTOR L=350
 E903	EV00001	POWER CORD, (AUSTRALIA) (CPT2199)
 E903	2972581	POWER CORD (CMT2198,CMT2196,CMT2187-191/192)
 E903	2972591	POWER CORD CEE (CMT2187-192R)
E904	2661751	2P PLUG PIN WITH BASE
E906	2720221	FUSE HOLDER
E907	2995909	AMP-IN CONNECTOR UL1672 L=220
E950	3721832	UNI TIE FASTNER
FBK283	2122652M	FERRITE CORE
FB601	2122653M	FERRITE CORE 1.65UH TAPE
FB781	2122653M	FERRITE CORE 1.65UH TAPE
FB901	2123468M	FERRITE BEADS CORE LEAD 0.8MH
FB902	2123468M	FERRITE BEADS CORE LEAD 0.8MH
FB903	2123468M	FERRITE BEADS CORE LEAD 0.8MH
FB904	2123468M	FERRITE BEADS CORE LEAD 0.8MH
FB905	2123468M	FERRITE BEADS CORE LEAD 0.8MH
FB906	2774731R	COIL-FERRITE BEADS CORE LEAD

PRODUCT SAFETY NOTE: Components marked with a  have special characteristics important to safety. Before replacing any of these components, read carefully the **PRODUCT SAFETY NOTICE** of this Service Manual. Don't degrade the safety of the receiver through improper servicing

	FB907	2771892	FERRITE BEADS CORE (004)
	FB908	2771892	FERRITE BEADS CORE (004)
	FB909	2771892	FERRITE BEADS CORE (004)
	F901	2720402	FUSE 3.15A IEC-127
	IC001	2004801	IC LA7920
	IC1101	CP00952	M37210M4-652SP (CPT2199)
	IC1101	2001929	IC M37210M4-650SP (CMT2198,CMT2196,CMT2187)
	IC1102	2381112	IC M6M80021P
	IC201	2004411	IC TDA8362
	IC402	2004362	IC CXA1279AS
	IC4501	2004022	IC AN7147N
	IC451	2020601	IC MM1053XS (CMT2198,CMT2196,CMT2187)
	IC501	2003652	IC TDA4661
	IC502	2004431	IC TDA8395(CMT2198,CMT2196,CMT2187)
	IC681	2020631	IC AN5515
	IC901	2373372	IC STR-D5095A
	IC902	2004761	IC TLP631
	L101	2122253M	COIL-AXIAL 100UH-K
	L1101	2123739R	RADIAL COIL 1UH-M TYPE EL0405
	L1102	2123298M	LAL AXIAL COIL 22UH-J
	L1103	2122956M	COIL-AXIAL 100UHKM BELTING
	L201	2123103M	COIL-AXIAL LAL 10UH-K(CMT2198,CMT2196,CMT2187)
	L202	2146114	COIL 7MM
	L203	2123411M	AXIAL COIL 1.0UH-K TYPE LAL02(CMT2198,CMT2196)
	L203	2123413M	AXIAL COIL 1.5UH TYPE LAL02(CMT2187)
	L204	2123411M	AXIAL COIL 1.0UH-K TYPE LAL02(CMT1298,CMT2196)
	L205	2123412M	LAL AXIAL COIL 1.2UH(CMT2198,CMT2196)
	L205	2123415M	LAL AXIAL COIL 2.2UH-K(CMT2187)
	L206	2122956M	COIL-AXIAL 100UHKM BELTING
	L401	2123104M	COIL-AXIAL 12UH-K(CMT2198,CMT2196,CMT2187)
	L401	2123107M	LALO2 AXIAL COIL 22UH-K(CPT2199)
	L402	2123107M	LALO2 AXIAL COIL 22UH-K(CPT2199)
	L501	2123102M	COIL-AXIAL 8.2UH-K(CMT2198,CMT2196,CMT2187)
	L502	2123104M	COIL-AXIAL 12UH-K(CPT2199,CMT2198,CMT2196)
	L505	2122253M	COIL-AXIAL 100UH-K(CMT2198,CMT2196)
	L507	2123103M	COIL-AXIAL LAL 10UH-K(CMT2198,CMT2196,CMT2187)
	L553	2122946M	COIL-AXIAL 18UHKM BELTING
	L768	2122253M	COIL-AXIAL 100UH-K
	L781	2164541	HORIZONTAL LINERARITY COIL
	L802	BH00204R	FILTER COIL 18UH
	L901	2122694	LINE FILTER (CPT2199)
	L901	2272391	LINE FILTER (CMT2198,CMT2196,CMT2187)
	L905	2276001A	DEGAUSSING COIL 21"4P CONN
	MF401	2167211	CERAMIC FILTER SFSL5.5MH(CPT2199)
	MF401	2167311	FILTER CERAMIC (4.5MHZ)(CMT2198,CMT2196)
	MF402	2167211	CERAMIC FILTER SFSL5.5MHCMT2198,CMT2196,CMT2187)
	MF403	2167212	CERAMIC FILTER SFSL6.0MDB(CMT2198,CMT2196,CMT2187)
	MF404	2167213	CERAMIC FILTER SFSL6.5MDB(CMT2198,CMT2196,CMT2187)
	MF501	2167371	CERAMIC TRAP COIL5.5/5.75MHZ(CMT2198,CMT2196,CMT2187)
	MF502	2143472	COMPOUND TRAP 6/6.5 MHZ(CMT2198,CMT2196,CMT2187)
	MF503	2142241	CERAMIC TRAP 4.5MHZ(CMT2198,CMT2196)
	MF503	2167371	CERAMIC TRAP COIL5.5/5.75MHZ(CPT2199)
	Q1101	2327773M	TRS.2SC3413 TAPE
	Q1102	2327774M	TRS.2SC3413D-TZ
	Q1104	2327773M	TRS.2SC3413 TAPE
	Q1105	2003522R	IC PST572D-2 (ANALOG IC)
	Q1106	2327773M	TRS.2SC3413 TAPE
	Q201	2320144M	TRS. 2SC1906 (TAPE)



PRODUCT SAFETY NOTE: Components marked with a  have special characteristics important to safety. Before replacing any of these components, read carefully the **PRODUCT SAFETY NOTICE** of this Service Manual. Don't degrade the safety of the receiver through improper servicing

	Q203	2326875R	DIGITAL TRS. DTC144WS(CMT2198,CMT2196)
	Q204	2327774M	TRS. 2SC3413D-TZ(CMT2198,CMT2196)
	Q205	2327774M	TRS. 2SC3413D-TZ(CMT2198,CMT2196)
	Q301	2327753M	TRS.2SA1390 TAPE (C/D)
	Q303	2326875R	DIGITAL TRS. DTC144WS
	Q401	2327773M	TRS.2SC3413 TAPE(CPT2199,CMT2187)
	Q501	2327773M	TRS.2SC3413 TAPE(CPT2198,CMT2196,CMT2187)
	Q502	2327773M	TRS.2SC3413 TAPE(CPT2199,CMT2198,CMT2196)
	Q506	2327773M	TRS.2SC3413 TAPE
	Q507	2327753M	TRS.2SA1390 TAPE (C/D)
	Q510	2327773M	TRS.2SC3413 TAPE
	Q721	CF00112R	TRS. 2SC4490-AN(R-300V)
	Q722	2323052	TRS. 2SD787 (D/E)(CPT2199)
	Q723	2312171	TRS. 2SC3852(CPT2199)
	Q723	2323052	TRS. 2SD787 (D/E)(CMT2198,CMT2196,CMT2187)
	Q724	2327753M	TRS. 2SA1390 TAPE (C/D)
	Q781	2315161	TRS. BU2508DF
	Q801	2327754M	TRS. 2SA1390D
	Q851	2312371	TRS. 2SC3942
	Q852	2312371	TRS. 2SC3942
	Q853	2312371	TRS. 2SC3942
	Q901	2326631	THYRISTOR CR5AS-8(B-A1)
	Q902	2327754M	TRS.2SA1390D
	Q903	2327773M	TRS.2SC3413 TAPE
	Q904	2315933	TRS. 2SB1548A P/Q
	Q905	2320647M	TRS. 2SC1213 (C 21 TZ/D 21 TZ)
	RK108	0700041M	RES.-CARBON FLM 1/16W 1.0KΩ
	R001	0700053M	RES.-CARBON FLM 1/16W 8.2KΩ
	R1001	0700041M	RES.-CARBON FLM 1/16W 1.0KΩ
	R101	0700058M	RES.-CARBON FLM 1/16W 22KΩ
	R1101	0110223S	RES.-MTL OXIDE FLM 120Ω
	R1102	0700051M	RES.-CARBON FLM 1/16W 5.6KΩ
	R1103	0700027M	RES.-CARBON FLM 1/16W 100Ω
	R1104	0700027M	RES.-CARBON FLM 1/16W 100Ω
	R1106	0700041M	RES.-CARBON FLM 1/16W 1.0KΩ
	R1107	0700054M	RES.-CARBON FLM 1/16W 10KΩ
	R1108	0700058M	RES.-CARBON FLM 1/16W 22KΩ
	R1109	0700058M	RES.-CARBON FLM 1/16W 22KΩ
	R1110	0700058M	RES.-CARBON FLM 1/16W 22KΩ
	R1111	0700027M	RES.-CARBON FLM 1/16W 100Ω
	R1112	0700027M	RES.-CARBON FLM 1/16W 100Ω
	R1113	0700027M	RES.-CARBON FLM 1/16W 100Ω
	R1114	0700051M	RES.-CARBON FLM 1/16W 5.6KΩ (CPT2199)
	R1115	0700051M	RES.-CARBON FLM 1/16W 5.6KΩ (CPT2199)
	R1116	0700027M	RES.-CARBON FLM 1/16W 100Ω (CPT2199)
	R1117	0700027M	RES.-CARBON FLM 1/16W 100Ω (CPT2199)
	R1118	0700067M	RES.-CARBON FLM 1/16W 100KΩ
	R1119	0700044M	RES.-CARBON FLM 1/16W 1.8KΩ
	R1120	0700035M	RES.-CARBON FLM 1/16W 390Ω(CMT2198,MCT2196,CMT2187)
	R1121	0700035M	RES.-CARBON FLM 1/16W 390Ω(CMT2198,MCT2196,CMT2187)
	R1122	0700041M	RES.-CARBON FLM 1/16W 1.0KΩ (CPT2199)
	R1123	0700041M	RES.-CARBON FLM 1/16W 1.0KΩ
	R1125	0700048M	RES.-CARBON FLM 1/16W 3.9KΩ
	R1126	0700048M	RES.-CARBON FLM 1/16W 3.9KΩ
	R1127	0700048M	RES.-CARBON FLM 1/16W 3.9KΩ
	R1128	0700055M	RES.-CARBON FLM 1/16W 12KΩ
	R1129	0700054M	RES.-CARBON FLM 1/16W 10KΩ
	R1130	0700054M	RES.-CARBON FLM 1/16W 10KΩ







PRODUCT SAFETY NOTE: Components marked with a  have special characteristics important to safety. Before replacing any of these components, read carefully the **PRODUCT SAFETY NOTICE** of this Service Manual. Don't degrade the safety of the receiver through improper servicing.

R1132	0700046M	RES.-CARBON FLM 1/16W 2.7KΩ
R1133	0700053M	RES.-CARBON FLM 1/16W 8.2KΩ
R1134	0700039M	RES.-CARBON FLM 1/16W 820Ω
R1135	0700054M	RES.-CARBON FLM 1/16W 10KΩ
R1136	0700054M	RES.-CARBON FLM 1/16W 10KΩ
R1137	0700045M	RES.-CARBON FLM 1/16W 2.2KΩ
R1138	0100081M	RES.-CARBON FLM 1/8W 4.7KΩ
R1139	0700054M	RES.-CARBON FLM 1/16W 10KΩ
R1139A	0187084M	RES.-CARBON FLM 1/16W 6.2KΩ(CMT2196)
R1139A	0700049M	RES.-CARBON FLM 1/16W 4.7KΩ(CPT2199,CMI2198,CMT2187)
R1140	0700054M	RES.-CARBON FLM 1/16W 10KΩ
R1141	0700055M	RES.-CARBON FLM 1/16W 12KΩ
R1142	0700052M	RES.-CARBON FLM 1/16W 6.8KΩ
R1143	0700056M	RES.-CARBON FLM 1/16W 15KΩ
R1144	0700052M	RES.-CARBON FLM 1/16W 6.8KΩ
R1145	0700052M	RES.-CARBON FLM 1/16W 6.8KΩ
R1146	0700051M	RES.-CARBON FLM 1/16W 5.6KΩ
R1147	0700027M	RES.-CARBON FLM 1/16W 100Ω
R1148	0700027M	RES.-CARBON FLM 1/16W 100Ω
R1149	0700041M	RES.-CARBON FLM 1/16W 1.0KΩ
R1150	0700041M	RES.-CARBON FLM 1/16W 1.0KΩ
R1151	0700054M	RES.-CARBON FLM 1/16W 10KΩ
R1154	0700061M	RES.-CARBON FLM 1/16W 33KΩ
R1155	0700058M	RES.-CARBON FLM 1/16W 22KΩ
R1156	0700058M	RES.-CARBON FLM 1/16W 22KΩ
R1157	0700045M	RES.-CARBON FLM 1/16W 2.2KΩ
R1158	0700045M	RES.-CARBON FLM 1/16W 2.2KΩ
R1159	0700027M	RES.-CARBON FLM 1/16W 100Ω
R1160	0700041M	RES.-CARBON FLM 1/16W 1.0KΩ
R1161	0700041M	RES.-CARBON FLM 1/16W 1.0KΩ
R1162	0700056M	RES.-CARBON FLM 1/16W 15KΩ
R1163	0700056M	RES.-CARBON FLM 1/16W 15KΩ
R1165	0700041M	RES.-CARBON FLM 1/16W 1.0KΩ
R1166	0700051M	RES.-CARBON FLM 1/16W 5.6KΩ
R1167	0700054M	RES.-CARBON FLM 1/16W 10KΩ
R1168	0700054M	RES.-CARBON FLM 1/16W 10KΩ
R1169	0700062M	RES.-CARBON FLM 1/16W 39KΩ
R1170	0700062M	RES.-CARBON FLM 1/16W 39KΩ
R1171	0700056M	RES.-CARBON FLM 1/16W 15KΩ
R1172	0700054M	RES.-CARBON FLM 1/16W 10KΩ
R1176	0700054M	RES.-CARBON FLM 1/16W 10KΩ
R1177	0700061M	RES.-CARBON FLM 1/16W 33KΩ
R1179	0700043M	RES.-CARBON FLM 1/16W 1.5KΩ
R1180	0700041M	RES.-CARBON FLM 1/16W 1.0KΩ
R1181	0700064M	RES.-CARBON FLM 1/16W 56KΩ
R1182	0700054M	RES.-CARBON FLM 1/16W 10KΩ
R1183	0700066M	RES.-CARBON FLM 1/16W 82KΩ
R1184	0700067M	RES.-CARBON FLM 1/16W 100KΩ
R1185	0700058M	RES.-CARBON FLM 1/16W 22KΩ
R1186	0700055M	RES.-CARBON FLM 1/16W 12KΩ (CMT2198,CMT2196,CMT2187)
R1186	0700058M	RES.-CARBON FLM 1/16W 22KΩ (CPT2199)
R1186A	0100117M	RES.-CARBON FLM 1/8W 150KΩ (CPT2199)
R1187	0700055M	RES.-CARBON FLM 1/16W 12KΩ
R1188	0700054M	RES.-CARBON FLM 1/16W 10KΩ
R1189	0700054M	RES.-CARBON FLM 1/16W 10KΩ
R1190	0700038M	RES.-CARBON FLM 1/16W 680Ω
R1191	0700038M	RES.-CARBON FLM 1/16W 680Ω
R1192	0700038M	RES.-CARBON FLM 1/16W 680Ω





PRODUCT SAFETY NOTE: Components marked with a  have special characteristics important to safety. Before replacing any of these components, read carefully the **PRODUCT SAFETY NOTICE** of this Service Manual. Don't degrade the safety of the receiver through improper servicing

R1194	0700052M	RES.-CARBON FLM 1/16W 6.9KΩ
R1200	0700057M	RES.-CARBON FLM 1/16W 18KΩ
R1202	0700041M	RES.-CARBON FLM 1/16W 1.0KΩ
R1203	0700038M	RES.-CARBON FLM 1/16W 680Ω
R201	0700048M	RES.-CARBON FLM 1/16W 3.9KΩ (CPT2199)
R201	0700052M	RES.-CARBON FLM 1/16W 6.8KΩ (CMT2198,CMT2196,CMT2187)
R202	0700037M	RES.-CARBON FLM 1/16W 560Ω (CPT2199)
R202	070042M	RES.-CARBON FLM 1/16W 1.2KΩ (CMT2198,CMT2196,CMT2187)
R203	0100047M	RES.-CARBON FLM 1/8W 180Ω
R204	0700019M	RES.-CARBON FLM 1/16W 27Ω
R207	0100054M	RES.-CARBON FLM 1/16W 10KΩ
R208	0700027M	RES.-CARBON FLM 1/16W 100Ω
R209	0700062M	RES.-CARBON FLM 1/16W 39KΩ
R210	0700058M	RES.-CARBON FLM 1/16W 22KΩ
R214	0700055M	RES.-CARBON FLM 1/16W 12KΩ (CMT2198,CMT2196,CMT2187)
R214	0700056M	RES.-CARBON FLM 1/16W 15KΩ (CPT2199)
R215	0700026M	RES.-CARBON 1/16W 82Ω
R221	0700045M	RES.-CARBON FLM 1/16W 2.2KΩ (CMT2198,CMT2196)
R225	0700027M	RES.-CARBON FLM 1/16W 100Ω (CMT2198,CMT2196)
R230	0700041M	RES.-CARBON FLM 1/16W 1.0KΩ (CMT2198,CMT2196,CMT2187)
R231	0700041M	RES.-CARBON FLM 1/16W 1.0KΩ (CMT2198,CMT2196,CMT2187)
R232	0700054M	RES.-CARBON FLM 1/16W 10KΩ (CMT2198,CMT2196)
 R234	0700048M	RES.-CARBON FLM 1/16W 3.9KΩ (CMT2198,CMT2196)
R240	0119687M	RES.-METAL OXIED FILM 4.7Ω
R250	0700032M	RES.-CARBON FLM 1/16W 220Ω
R260	0700041M	RES.-CARBON FLM 1/16W 1.0KΩ
R265	0700058M	RES.-CARBON FLM 1/16W 22KΩ (CMT2198,CMT2196)
R266	0700053M	RES.-CARBON FLM 1/16W 8.2KΩ (CMT2198,CMT2196)
R267	0700063M	RES.-CARBON FLM 1/16W 47KΩ (CMT2198,CMT2196)
R268	0700058M	RES.-CARBON FLM 1/16W 22KΩ (CMT2198,CMT2196)
R302	0100038M	RES.-CARBON FLM 1/8W 75Ω
R303	0700027M	RES.-CARBON FLM 1/16W 100Ω
R304	0700067M	RES.-CARBON FLM 1/16W 100KΩ
R305	0700027M	RES.-CARBON FLM 1/16W 100Ω
R306	0700067M	RES.-CARBON FLM 1/16W 100KΩ
R307	0700027M	RES.-CARBON FLM 1/16W 100Ω
R308	0700025M	RES.-CARBON FLM 1/16W 68Ω
R309	0100045M	RES.-CARBON FLM 1/8W 150Ω
R310	0700027M	RES.-CARBON FLM 1/16W 100Ω
R312	0700067M	RES.-CARBON FLM 1/16W 100KΩ
R314	0700067M	RES.-CARBON FLM 1/16W 100KΩ
R315	0700027M	RES.-CARBON FLM 1/16W 100Ω
R320	0700067M	RES.-CARBON FLM 1/16W 100KΩ
R321	0700034M	RES.-CARBON FLM 1/16W 330Ω
R332	0700057M	RES.-CARBON FLM 1/16W 18KΩ
R333	0700027M	RES.-CARBON FLM 1/16W 100Ω
R401	0700027M	RES.-CARBON FLM 1/16W 100Ω (CPT2199)
R401	0700035M	RES.-CARBON FLM 1/16W 390Ω (CMT2198,CMT2196,CMT2187)
R402	0700058M	RES.-CARBON FLM 1/16W 22KΩ
R403	0700054M	RES.-CARBON FLM 1/16W 10KΩ
 R404	0119505S	RES.-MTL FLM 1/4W 2.2Ω
 R405	0119505S	RES.-MTL FLM 1/4W 2.2Ω
R410	0700032M	RES.-CARBON FLM 1/16W 220Ω (CMT2196)
R410	0700036M	RES.-CARBON FLM 1/16W 470Ω (CPT2199,CMT2198,CMT2187)
R411	0700032M	RES.-CARBON FLM 1/16W 220Ω (CMT2196)
R411	0700036M	RES.-CARBON FLM 1/16W 470Ω (CPT2199,CMT2198,CMT2187)
R419	0700067M	RES.-CARBON FLM 1/16W 100KΩ
R427	0700041M	RES.-CARBON FLM 1/16W 1.0KΩ



PRODUCT SAFETY NOTE: Components marked with a  have special characteristics important to safety. Before replacing any of these components, read carefully the **PRODUCT SAFETY NOTICE** of this Service Manual. Don't degrade the safety of the receiver through improper servicing

R701	0700056M	RES.-CARBON FLM 1/16W 15KΩ
R703	0700034M	RES.-CARBON FLM 1/16W 330Ω
R706	0700059M	RES.-CARBON FLM 1/16W 27KΩ
R707	0700041M	RES.-CARBON FLM 1/16W 1.0KΩ
R710	0100131M	RES.-CARBON FLM 1/8W 560KΩ
R711	0100123M	RES.-CARBON FLM 1/8W 270KΩ
R712	0100125M	RES.-CARBON FLM 1/8W 330KΩ
R720	0110251S	RES.-MTL OXIDE FLM 1.8KΩ
R721	0110247S	RES.-MTL OXIDE FLM 1.2KΩ
R722	0113746M	RES.-CARBON FLM 1/2W 680Ω
R723	0100051M	RES.-CARBON FLM 1/8W 270Ω
R724	0700041M	RES.-CARBON FLM 1/16W 1.0KΩ
R725	0700054M	RES.-CARBON FLM 1/16W 10KΩ
 R726	0700063M	RES.-CARBON FLM 1/16W 47KΩ
R727	0700054M	RES.-CARBON FLM 1/16W 10KΩ
R730	0700042M	RES.-CARBON FLM 1/16W 1.2KΩ
R733	0113727M	RESISTOR CARBON FILM SRD1/2P-B 120Ω
R734	0700014M	RES.-CARBON FLM 1/16W 10Ω
R741	0110211S	RES.-MTL OXIDE FLM 39Ω (CPT2199)
R741A	0110201S	RES.-MTL OXIDE FLM 2W 15Ω (CPT2199)
R742	0100049M	RES.-CARBON FILM 1/8W 220Ω (CPT2199)
 R751	0114223M	RESISTOR-CARBON FILM SRD 1/4W 82KΩ
 R752	0114223M	RESISTOR-CARBON FILM SRD 1/4W 82KΩ
 R757	0118970M	RES.-METAL FILM 1/16W 240KΩ
 R758	0119647M	RES.-MTL FILM 1/8W 47KΩ
R759	0110279S	RES.-MTL OXIDE FLM 27KΩ
R760	0700041M	RES.-CARBON FLM 1/16W 1.0KΩ
R761	0700041M	RES.-CARBON FLM 1/16W 1.0KΩ
R762	0100073M	RES.-CARBON FLM 1/8W 2.2KΩ
 R764	0119505S	RES.-MTL FLM 1/4W 2.2Ω
R768	0100077M	RES.-CARBON FLM 1/8W 3.3KΩ
 R781	0147626	RES.-WIRE WOUND 7W 4.7Ω
R782	0113748M	RES.-CARBON FLM 1/2 P-B 820Ω
R801	0700027M	RES.-CARBON FLM 1/16W 100Ω
R802	0700027M	RES.-CARBON FLM 1/16W 100Ω
R803	0700027M	RES.-CARBON FLM 1/16W 100Ω
R804	0700033M	RES.-CARBON FLM 1/16W 270Ω
R805	0700035M	RES.-CARBON FLM 1/16W 390Ω
R806	0700033M	RES.-CARBON FLM 1/16W 270Ω
R807	0700044M	RES.-CARBON FLM 1/16W 1.8KΩ
R808	0700044M	RES.-CARBON FLM 1/16W 1.8KΩ
R809	0700044M	RES.-CARBON FLM 1/16W 1.8KΩ
R811	0110271S	RES.-MTL OXIDE FLM 2W 12KΩ
R812	0110271S	RES.-MTL OXIDE FLM 2W 12KΩ
R813	0110271S	RES.-MTL OXIDE FLM 2W 12KΩ
R814	0113744M	RESISTOR CARBON FLM SRD1/2P-B 560Ω
R815	0113744M	RESISTOR CARBON FLM SRD1/2P-B 560Ω
R816	0113744M	RESISTOR CARBON FLM SRD1/2P-B 560Ω
R817	0700037M	RES.-CARBON FLM 1/16W 560Ω
R818	0700037M	RES.-CARBON FLM 1/16W 560Ω
R819	0700037M	RES.-CARBON FLM 1/16W 560Ω
R820	0700045M	RES.-CARBON FLM 1/16W 2.2KΩ
R821	0700046M	RES.-CARBON FLM 1/16W 2.7KΩ
R822	0700046M	RES.-CARBON FLM 1/16W 2.7KΩ
R823	0700046M	RES.-CARBON FLM 1/16W 2.7KΩ
R824	0700046M	RES.-CARBON FLM 1/16W 2.7KΩ
R850	0100041M	RES.-CARBON FLM 1/8W 100Ω
R901	0147614X	RES.-WIRE WOUND 7W 1.5Ω



PRODUCT SAFETY NOTE: Components marked with a  have special characteristics important to safety. Before replacing any of these components, read carefully the **PRODUCT SAFETY NOTICE** of this Service Manual. Don't degrade the safety of the receiver through improper servicing

R901A	0147616	RES.-WIRE WOUND 7W 1.8Ω
R902	0113791M	RES.-CARBON FLM 1/2W 47KΩ
R903	0113791M	RES.-CARBON FLM 1/2W 47KΩ
R905	0100063M	RES.-CARBON FLM 1/8W 820Ω
R908	0113701M	RESISTOR CARBON FILM SRD1/2P-B 10Ω
R909	019406BF	RES.-WIRE WOUND 2W 1.0Ω
R910	0110275S	RES.-MTL OXIDE FLM 18KΩ
R911	0700042M	RES.-CARBON FLM 1/16W 1.2KΩ
R912	0700041M	RES.-CARBON FLM 1/16W 1.0KΩ
R913	0700039M	RES.-CARBON FLM 1/16W 820Ω
R914	0110135S	RES.-MTL OXIDE FLM 390Ω
R915	0114165M	RESISTOR-CARBON FILM SRD 1/4 W 1.5Ω
R916	0700049M	RES.-CARBON FLM 1/16W 4.7KΩ
R917	0700054M	RES.-CARBON FLM 1/16W 10KΩ
R918	0700029M	RES.-CARBON FLM 1/16W 150Ω
R919	0100077M	RES.-CARBON FLM 1/8W 3.3KΩ
R920	0100121M	RES.-CARBON FLM 1/8W 220KΩ
R921	0100123M	RES.-CARBON FLM 1/8W 270KΩ
R922	0700054M	RES.-CARBON FLM 1/16W 10KΩ
R923	0700049M	RES.-CARBON FLM 1/16W 4.7KΩ
R924	0110275S	RES.-MTL OXIDE FLM 18KΩ
R925	0113701M	RESISTOR CARBON FILM 10Ω 1/2W (CMT2198,CMT2196,CMT2187)
R926	0113797M	RES.-CARBON FLM 1/2W 82KΩ
R930	0700014M	RES.-CARBON FLM 1/16W 10Ω
R950	0700028M	RES.-CARBON FLM 1/16W 120Ω
 R998	0174704G	RES.-METAL OXIDE 10MΩ TYPE V R68
S1101	2632851	5KEY TACT SWITH
 S901	2634731	POWER SWITCH TYPE 02-01HPO-SDD FA3
TH901	2341323	THERMISTOR 14 OHM
T721	2260221	HORIZONTAL DRIVE COIL
T722	2276081	H. DRIVE TRANS
 T761	2437351	FBT TYPE HFL1427M
 T901	2216331	SWITCHING TRANS (78VA)
 U001	HJ00071	TUNER ET-675SN
VR202	0150265	RESISTOR-VARIABLE RV06 10K-B
VR601	0150109	RES.-VARIABLE RV6 200-B
VR701	0150114	RES.-VARIABLE RV6 10K-B
VR801	0150110	RES.-VARIABLE RV6 500-B
VR802	0150110	RES.-VARIABLE RV6 500-B
VR803	0150110	RES.-VARIABLE RV6 500-B
VR804	0150109	RES.-VARIABLE RV6 200-B
VR806	0150109	RES.-VARIABLE RV6 200-B
W10	9374697	WIRE UL1015 CSATEW AWG18 BLACK
W301	9374575	UL CSA1007-24HP CODE GREEN
W401	9374592	SOLDER COATED WIRE UL1007 CSATR64 A
W403	9374697	WIRE UL1015 CSATEW AWG18 BLACK
W404	9374575	UL CSA1007-24HP CODE GREEN
W450	9374575	UL CSA1007-24HP CODE GREEN
W701	9374575	UL CSA1007-24HP CODE GREEN
W702	9374575	UL CSA1007-24HP CODE GREEN
W801	9374575	UL CSA1007-24HP CODE GREEN
W901	9374575	UL CSA1007-24HP CODE GREEN
X1101	2792071	CERAMIC OSC CST4-00MGW
X501	2791505	CRYSTAL HC-491U 3.58HMZ
X504	2170043	OSCILLATOR 4.43MHZ
Z	9414017	SILICONE COMPOUND (G-746)
ZC710	9451104	VARNISH CLOTH TUBE 0.8X1.8 YELLOW
ZC710A	9451104	VARNISH CLOTH TUBE 0.8X1.8 YELLOW

PRODUCT SAFETY NOTE: Components marked with a  have special characteristics important to safety. Before replacing any of these components, read carefully the **PRODUCT SAFETY NOTICE** of this Service Manual. Don't degrade the safety of the receiver through improper servicing

ZD1001	2339819M	ZENER HZS3C3 TA
ZD1101	2339837M	ZENER HZS-5C1 TAPE
ZD201	2331349M	ZENER HZ12C3 (TA)
ZD501	2331795M	ZENER HZ-5 (B2 TAPE)
ZD503	2339369M	ZENER HZS9C3 TA
ZD601	2339827M	ZENER HZS4C1 TA
ZD610	2339231M	ZENER HZS30-1L TA
ZD611	2339231M	ZENER HZS30-1L TA
ZD701	2331817M	ZENER DIODE HZ-7 TAPE (C1)
ZD702	2339869M	ZENER HZS9C3 TA
ZD705	2339869M	ZENER HZS9C3 TA
 ZD721	2339854M	ZENER HZS7B1 TA
 ZD751	2339222M	ZENER HZS27-2L
ZD752	2339843M	ZENER HZS-6 A3 (SI 200MA)(CPT2199)
ZD753	2339867M	ZENER HZS-9-C1 TAPE (SI.200MA)
ZD754	2335991M	ZENER HZ-T33 (02 TP)
ZD755	2339831M	ZENER HZS5 A1 TA
ZD801A	2331836M	ZENER DIODE HZ-11 TAPE(B3)SI. 200MW
ZD810	2331797M	ZENER DIODE HZ-5 TAPE (C1)
ZD902	2331814M	ZENER DIODE HZ-7 TAPE (B1)
ZD903	2339921M	ZENER HZS20-1 TA
ZD904	2339847M	ZENER HZS6C1 TA
ZD905	2339231M	ZENER HZS30-1L TA
ZD906	2339231M	ZENER HZS30-1L TA
ZD907	2339851M	ZENER HZS7A1 TAPE (SI.200MA)
ZE801	9413926	SILICON RUBBER
ZFB	9413926	SILICON RUBBER (CPT2199,CMT2198,CMT2196,CMT2187-191/192)
Z1T	9413926	SILICON RUBBER
Z10TT	9413926	SILICON RUBBER (CPT 2199)
Z11TT	9413926	SILICON RUBBER (CPT 2199)
Z1145	9451104	VARNISH CLOTH TUBE 0.8X1.8 YELLOW (CPT 2199)
Z202A	9451104	VARNISH CLOTH TUBE 0.8X1.8 YELLOW
Z602	9451136	UL CSA TUBE NO.8
Z7TT	2784342	CONDENSER COVER
Z702	9451136	UL CSA TUBE NO.8
Z801A	9451104	VARNISH CLOTH TUBE 0.8X1.8 YELLOW
Z901	9485158	HOT MELT (AX-1503C)
Z920	9413926	SILICON RUBBER
Z990	9413926	SILICON RUBBER
#0103	QD00028	FRAME ASS'Y CMT2198
#0105	QD00029	FRAME ASS CMT2196-982
#0106	QD00026	FRAME SASS'Y CPT2199-751
#0107	QD03111	FRAME ASS'Y CMT2187
#0112	3487484	HITACHI BADGE 55G
#0126	3332453	E60 KNOB SPRING
#0128	3828321	R/C LENS C21-888
#0130A	MS00011	SP NET CMT2198
#0130B	MS00011	SP NET CMT2198
#0131	NJ00181	SUPPORT PIECE 2598 B
#0132	3874861	ADHESION BOS C21-888
#0134	3871332	CRT BKT CMT2118
#0136	4519512	4X16 B TAPPING SCREW
#0138	4159423	SCR NO 3X12 FL/FLT
#0140	3822091	VR DOOR C21-888 (CMT2198)
#0141	3875771	LATCH 4T02 NYLON (CMT2198)
#0142	3815301	BUTTON HOLDER EV1
#0148	3274201	POWER KNOB C21-888
#0150	QD00043	COVER ASS'Y CMT2198

PRODUCT SAFETY NOTE: Components marked with a  have special characteristics important to safety. Before replacing any of these components, read carefully the **PRODUCT SAFETY NOTICE** of this Service Manual. Don't degrade the safety of the receiver through improper servicing.

#0152	3875531	CORD HOLDER CT2043
#0156	MS00031	HIMERON
#0158	MS00032	HIMERON SHEET
#0180	4518376	SCREW 6X25 TAPPING WITH WSR SAE
#0181	8781450	SCREW-3*20 TAPPING
#0182	4519512	4X16 B TAPPING SCREW STEEL
#0183	4519512	4X16 B TAPPING SCREW STEEL (CPT2199,CMT2196,CMT2187)
#0184	4519512	4X16 B TAPPING SCREW STEEL (CMT2198)
#0186	4519511	4X12 B TAPPING SCREW STEEL
#0190	3876121	FBT SUPPORT CMT2195 PA
#0192	3274192	CONTROL KNOB CMT2198
#0194	4159423	SCR NO 3X12 FL/FLT
#0195	8815126	WASHER-4LOCKING
#0200	4756502	SAA ANTENNA LABEL (CPT2199)
#0205	QL03521	RATING LABEL CPT2199-752
#0206	QL03511	RATING LABEL CMT2198-194
#0207	QL02402	RATING LABEL CMT2196-982
#0208	QL03501	RATING LABEL CMT2198-191
E1	3731081	PURSE LOCK
E7	3744161	PURSE LOCK 25
E8T	3728272	PURSE LOCK 8 (CMT2198)
N	3705233	CLAMP ANODE
N3	2772982	FERRITE SHEET
RP401	0100089M	RES.-CARBON FLM 1/8W 10KΩ
RP402	0100089M	RES.-CARBON FLM 1/8W 10KΩ
SP401	2414964	SPEAKER 6.5*15(SQUARE)
SP402	2414964	SPEAKER 6.5*15(SQUARE)
WL	2976143	2P CONNECTOR WITH LEAD
WP401	9374731	WIRE UL1007 7/0.26 SN BLACK
WP402	9374731	WIRE UL1007 7/0.26 SN BLACK
WR	2976755	3P CONNECTOR WITH LEAD
ZP401	0544510	TERMINAL PIECE
ZP402	0544510	TERMINAL PIECE
Z1	9413945	CILICONE KE-1300 (WHITE)
Z2	9449598	NITTOH TAPE NO.188
E001	2905241	ANT. ADAPTOR (CPT2199,CMT2198,CMT2196,CMT2187)
E003	2941311	MANGAN DRY BATTERY EVEREADY(CPT2199,CMT2198,CMT2196,CMT2187)
E004	EP00001	SIEMENS ADAPTOR(CMT2198,CMT2196,CMT2187)
N001	QR05981	CMT2198/2196 (INSTRUCTION MANUAL) AR (CMT2198,CMT2196)
N001	QR05991	CMT2198/2196 (INSTRUCTION MANUAL) RU (CMT2198,CMT2196)
N001	QR06001	CMT2198/2196 (INSTRUCTION MANUAL) ENG (CMT2198,CMT2196)
N001	QR06241	CMPT2199-751 (INSTRCUTION MANUAL) (CPT2199)
N001	QR07601	CMT2187 OPERATION GUIDE (CMT2187)
N003	4914896	USER CAUTION SHEET (CMT2198,CMT2196,CMT2187)
U1001	HL00012	CLE 900A (CPT2199)
U1001	2574101	R/C HAND SET CLE-898 (CMT2198,CMT2196,CMT2187)
E001	9449538	NITTO TAPE NO.5 W25 (BLACK)
E0701	2788084	CRT EARTH WIRE 20INCH SF
E701	2776242	CONVEGENCE FREE MAGNET(30.2)
N01	4615641	WEDGE
 U701	BY00411	DY=C90-21SF3
 V1	2471272	CPT A51KPD12XX (KINSEI) (CMT2198)
V1	2471274	PICTURE TUBE A51KPD12XX(S) (CPT2199)
#0103	3333921	EARTH SPRING
#0104	3870211	DEGAUSS COIL HOLDER
#0135	9449506	SCOTCH TAPE NO.29 19MM
#0221	3763752	SK BINDER 200

PRODUCT SAFETY NOTE: Components marked with a  have special characteristics important to safety. Before replacing any of these components, read carefully the **PRODUCT SAFETY NOTICE** of this Service Manual. Don't degrade the safety of the receiver through improper servicing.

SIF PWB ASS PART LIST (CPT2199-751 ONLY)

SYMBOL NO.	PART NO.	DESCRIPTION
B2001	JK00641	S2 SIF PWB
CP2001	2306112	SAW K9253M
C2201	0880009R	CAP.-POLYESTER 0.01UF 50V
C2202	0800049R	CAP.-ELECTRO. 100UF 16V
C2203	0880009R	CAP.-POLYESTER 0.01UF 50V
C2204	0880009R	CAP.-POLYESTER 0.01UF 50V
C2205	0890076R	CAP.-CERAMIC 150PF-K 50V
C2206	0800277R	CAP.-ELECTRO. 0.47UF 50V
C2207	0880014R	MYLAR CAPACITOR 0.047UF
C2208	0800001R	CAP.-ELECTRO. 0.47UF 50W (SME)
C2209	0880009R	CAP.-POLYESTER 0.01UF 50V
C2210	0890087R	CAP.-CERAMIC 1000PF 50V
C2211	0890087R	CAP.-CERAMIC 1000PF 50V
C2212	0880009R	CAP.-POLYESTER 0.01UF 50V
C2215	0880009R	CAP.-POLYESTER 0.01UF 50V
C2219	0880009R	CAP.-POLYESTER 0.01UF 50V
C2413	0800015R	CAP.-ELECTRO. 10UF 16V
C2414	0800015R	CAP.-ELECTRO. 10UF 16V
C2415	0800015R	CAP.-ELECTRO. 10UF 16V
C2416	0800015R	CAP.-ELECTRO. 10UF 16V
C2419	0800015R	CAP.-ELECTRO. 10UF 16V
C2420	0800049R	CAP.-ELECTRO. 100UF 16V
C2423	0880009R	CAP.-POLYESTER 0.01UF 50V
E2001	2997055	7P CONNECTOR TYPE TXC
E2002	2997055	7P CONNECTOR TYPE TXC
E2003	3707211	PLASTIC RIVET (BLACK)
E2005	9371901	SOLDER COATED ANNEALED COPPER WIRE
IC2201	2004171	IC-LA7577
L2201	2146116	CARRIR FILTER COIL
L2202	2122956M	COIL-AXIAL 100UH
L2203	2123407M	LAL AXIAL COIL 0.47UH
Q2013	2320144M	TRS. 2SC1906
Q2014	2320591M	TRS. 2SC458
Q2015	2320144M	TRS. 2SC1906
R2015	0700041M	RES.-CARBON FLM 1/16W 1.0KΩ
R2016	0700037M	RES.-CARBON FLM 1/16W 560Ω
R2017	0700018M	RES.-CARBON FLM 1/16W 22Ω
R2018	0700047M	RES.-CARBON FLM 1/16W 3.3KΩ
R2019	0700037M	RES.-CARBON FLM 1/16W 560Ω
R2020	0114131M	RES.-CARBON FLM 1/4W 100Ω
R2202	0700059M	RES.-CARBON FLM 1/16W 27KΩ
R2203	0700045M	RES.-CARBON FLM 1/16W 2.2KΩ
R2205	0700041M	RES.-CARBON FLM 1/16W 1.0KΩ
R2206	0700023M	RES.-CARBON FLM 1/16W 47Ω
R2207	0700059M	RES.-CARBON FLM 1/16W 27KΩ
R2208	0700059M	RES.-CARBON FLM 1/16W 27KΩ
R2209	0700027M	RES.-CARBON FLM 1/16W 100Ω
R2210	0700035M	RES.-CARBON FLM 1/16W 390Ω
R2406	0700031M	RES.-CARBON FLM 1/16W 180Ω
R2419	0700067M	RES.-CARBON FLM 1/16W 100KΩ
R2420	0700067M	RES.-CARBON FLM 1/16W 100KΩ
R2430	0100057M	RES.-CARBON FLM 1/8W 470Ω

PRODUCT SAFETY NOTE: Components marked with a  have special characteristics important to safety. Before replacing any of these components, read carefully the **PRODUCT SAFETY NOTICE** of this Service Manual. Don't degrade the safety of the receiver through improper servicing.

A2 SOUND PWB ASS PART LIST (CPT2199 ONLY)

SYMBOL NO.	PART NO.	DESCRIPTION
#01	NA02352	MTS METAL
B4401	JK01981	S2 A2 PWB
C2403	0800005R	CAP.-ELECTRO. 2.2UF 50V
C2404	0800005R	CAP.-ELECTRO. 2.2UF 50V
C2405	0800005R	CAP.-ELECTRO. 2.2UF 50V
C2410	0893014R	CAP 2125CHIP 10000PF 25V
C2411	0800047R	CAP.-ELECTRO. 100UF 6.3V
C2429	0800005R	CAP.-ELECTRO. 2.2UF 50V
C2430	0800005R	CAP.-ELECTRO. 2.2UF 50V
C2431	0800015R	CAP.-ELECTRO. 10UF 16V
C4451	0800015R	CAP.-ELECTRO. 10UF 16V
C4452	0893014R	CAP 2125CHIP 10000PF 25V
C4453	0893014R	CAP 2125CHIP 10000PF 25V
C4454	0893037R	CAP 2125CHIP 3300PF 50V
C4455	0800058R	CAP.-ELECTRO. 220UF 16V
C4458	0800005R	CAP.-ELECTRO. 2.2UF 50V
C4459	0800005R	CAP.-ELECTRO. 2.2UF 50V
C4460	0893014R	CAP 2125CHIP 10000PF 25V
C4461	0893027R	CAPACITOR 2125 CHIP 100000PF 25V
C4462	0893014R	CAP 2125CHIP 10000PF 25V
C4463	0800048R	CAP.-ELECTRO. 100UF 10V
C4464	0228046R	CC73SCH1H470JR
C4465	0228010R	CAP2125CHIP 10PF 50V
D4401	2338321M	DIODE 1SS270 (TA)
E4401	ED00376	PIN HEADER 17P 6035B
E4403	2122652M	FERRITE CORE
IC2401	2020791	ICL-TDA9821
IC4451	2004972	TDA9840T
L2401	2123116M	COIL-AXIAL 100UH
L4401	2123116M	COIL-AXIAL 100UH
L4450	2146081	7MM COIL
MF2403	2142602	CERAMIC FILTER SFE5.5MHZ B9
MF2404	2142783	CERAMIC FILTER 5.74MHZ
Q2401	2327773M	TRS.2SC3413
Q2402	2327773M	TRS.2SC3413
Q4401	2327773M	TRS.2SC3413
Q4402	2327773M	TRS.2SC3413
R2404	0195908R	RMC73S-2A222JR
R2405	0195902R	RES 2125 CHIP 1/16W 1.2KΩ
R2407	0195935R	RMC73S-2A273JR
R2408	0195885R	RESISTOR 2125 CHIP 1/16W 270Ω
R2409	0195908R	RMC73S-2A222JR
R2410	0195935R	RMC73S-2A273JR
R2411	0195927R	RES 2125 CHIP 1/16W 12KΩ
R2412	0195900R	RES 2125 CHIP 1/16W 1KΩ
R2413	0195900R	RES 2125 CHIP 1/16W 1KΩ
R2414	0195910R	RMC73S-2A272JR
R2415	0195900R	RES 2125 CHIP 1/16W 1KΩ
R2416	0195922R	RES 2125 CHIP 1/16W 8.2KΩ
R2417	0195933R	RMC73S-2A223JR
R2427	0195883R	RES 2125 CHIP 1/16W 220Ω
R2428	0195883R	RES 2125 CHIP 1/16W 220Ω
R4460	0195937R	RMC73S-2A333JR
R4467	0195875R	RES 2125 CHIP 1/16W 100Ω

PRODUCT SAFETY NOTE: Components marked with a  have special characteristics important to safety. Before replacing any of these components, read carefully the **PRODUCT SAFETY NOTICE** of this Service Manual. Don't degrade the safety of the receiver through improper servicing

SYMBOL NO.	PART NO.	DESCRIPTION
R4468	0195875R	RES 2125 CHIP 1/16W 100Ω
R4470	0195875R	RES 2125 CHIP 1/16W 100Ω
R4471	0195875R	RES 2125 CHIP 1/16W 100Ω
R4472	0195875R	RES 2125 CHIP 1/16W 100Ω
R4473	0195875R	RES 2125 CHIP 1/16W 100Ω
R4474	0195891R	RES 2125 CHIP 1/16W 470Ω
R4475	0195891R	RES 2125 CHIP 1/16W 470Ω
W01	9374575	UL CSA1007-24HP CODE GREEN
X4451	2168941	X'TAL 10MHZ

ECHO PWB ASS PART LIST (CMT2198 ONLY)

SYMBOL NO.	PART NO.	DESCRIPTION
#0102	NA00131	BRACKET
B1601	JK00301	KARAOKE PWB
C1601	0890087R	CAP.-CERAMIC 1000PF-K 50V
C1602	0800015R	CAP.-ELECTRO. 10UF 16V
C1603	0800015R	CAP.-ELECTRO. 10UF 16V
C1604	0800049R	CAP.-ELECTRO. 100UF 16V
C1605	0800003R	CAP.-ELECTRO. 1.0UF 50V
C1606	0800032R	CAP.-ELECTRO. 33UF 16V
C1607	0800003R	CAP.-ELECTRO. 1.0UF 50V
C1608	0880016R	CAP.-POLYESTER FILM 0.1UF 50V
C1609	0244107R	CAP.-CERAMIC 3300PF 50V TAPE
C1610	0244107R	CAP.-CERAMIC 3300PF 50V TAPE
C1611	0880008R	MYLAR CAPACITOR 6800P
C1612	0244103R	CAPACITOR-CERAMIC 0.0015UF B 50WV
C1613	0248696R	CAP.-CERAMIC 330PF-J SL 50V TAPE
C1614	0249093R	CAPACITOR-CERAMIC 470PF SL 50WV
C1615	0249093R	CAPACITOR-CERAMIC 470PF SL 50WV
C1616	0880016R	CAP.-POLYESTER FILM 0.1UF 50V
C1617	0880012R	MYLAR CAPACITOR 0.022UF
C1618	0880012R	MYLAR CAPACITOR 0.022UF
C1619	0880016R	CAP.-POLYESTER FILM 0.1UF 50V
C1620	0800007R	CAP.-ELECTRO. 3.3UF 50V
C1621	0800047R	CAP.-ELECTRO. 100UF 6.3V
C1622	0880016R	CAP.-POLYESTER FILM 0.1UF 50V
C1623	0800007R	CAP.-ELECTRO. 3.3UF 50V
C1624	0880016R	CAP.-POLYESTER FILM 0.1UF 50V
C1625	0800047R	CAP.-ELECTRO. 100UF 6.3V
C1626	0800015R	CAP.-ELECTRO. 10UF 16V
C1627	0800015R	CAP.-ELECTRO. 10UF 16V
C1628	0800015R	CAP.-ELECTRO. 10UF 16V
C1629	0880011R	MYLAR CAPACITOR 0.015UF
C1630	0800041R	CAP.-ELECTRO. 47UF 16V
C1631	0800012R	CAP.-ELECTRO. 4.7UF 50V
C1632	0800015R	CAP.-ELECTRO. 10UF 16V
C1633	0800015R	CAP.-ELECTRO. 10UF 16V
C1634	0800015R	CAP.-ELECTRO. 10UF 16V
C1635	0800015R	CAP.-ELECTRO. 10UF 16V
C1636	0800015R	CAP.-ELECTRO. 10UF 16V
C1637	0800015R	CAP.-ELECTRO. 10UF 16V
C1638	0880012R	MYLAR CAPACITOR 0.022UF
C1639	0800048R	CAP.-ELECTRO. 100UF 10V
C1640	0800081	CAP.-ELECTRO. 1000UF 10V

PRODUCT SAFETY NOTE: Components marked with a  have special characteristics important to safety. Before replacing any of these components, read carefully the **PRODUCT SAFETY NOTICE** of this Service Manual. Don't degrade the safety of the receiver through improper servicing.

SYMBOL NO.	PART NO.	DESCRIPTION
D1601	233832IM	DIODE 1SS270 (TA)
E1601	EF00591	4J-5J EH CONNECTOR L=200
IC1601	CP00131U	ANALOG MONOLITHIC IC (CXA1643P)
IC1602	CP00141U	DIGITAL MONOLITHIC IC (CXA1644P)
IC1603	2362606	IC NJM4558D
JA1601	2677756	MIC JACK
Q1601	2327773M	TRS.2SC3413 TAPE
Q1602	2327773M	TRS.2SC3413 TAPE
Q1603	2327773M	TRS.2SC3413 TAPE
Q1604	2327773M	TRS.2SC3413 TAPE
Q1605	2327773M	TRS.2SC3413 TAPE
Q1606	2320644	TRS.2SC1213 (D)
R1601	0100065M	RES.-CARBON FLM 1/8W 1K Ω
R1602	0100065M	RES.-CARBON FLM 1/8W 1K Ω
R1603	0700054M	RES.-CARBON FLM 1/16W 10K Ω
R1604	0700058M	RES.-CARBON FLM 1/16W 22K Ω
R1605	0700054M	RES.-CARBON FLM 1/16W 10K Ω
R1606	0700061M	RES.-CARBON FLM 1/16W 33K Ω
R1607	0700054M	RES.-CARBON FLM 1/16W 10K Ω
R1608	0700058M	RES.-CARBON FLM 1/16W 22K Ω
R1609	0700054M	RES.-CARBON FLM 1/16W 10K Ω
R1610	0700061M	RES.-CARBON FLM 1/16W 33K Ω
R1611	0700061M	RES.-CARBON FLM 1/16W 33K Ω
R1612	0700061M	RES.-CARBON FLM 1/16W 33K Ω
R1614	0700064M	RES.-CARBON FLM 1/16W 56K Ω
R1616	0700063M	RES.-CARBON FLM 1/16W 47K Ω
R1617	0700061M	RES.-CARBON FLM 1/16W 33K Ω
R1621	0700041M	RES.-CARBON FLM 1/16W 1.0K Ω
R1622	0700041M	RES.-CARBON FLM 1/16W 1.0K Ω
R1623	0700064M	RES.-CARBON FLM 1/16W 56K Ω
R1624	0700049M	RES.-CARBON FLM 1/16W 4.7K Ω
R1625	0700064M	RES.-CARBON FLM 1/16W 56K Ω
R1627	0700027M	RES.-CARBON FLM 1/16W 100 Ω
R1628	0700027M	RES.-CARBON FLM 1/16W 100 Ω
R1629	0700045M	RES.-CARBON FLM 1/16W 2.2K Ω
R1630	0700045M	RES.-CARBON FLM 1/16W 2.2K Ω
R1631	0700045M	RES.-CARBON FLM 1/16W 2.2K Ω
R1632	0700045M	RES.-CARBON FLM 1/16W 2.2K Ω
R1633	0700041M	RES.-CARBON FLM 1/16W 1.0K Ω
R1634	0700067M	RES.-CARBON FLM 1/16W 100K Ω
R1635	0700045M	RES.-CARBON FLM 1/16W 2.2K Ω
R1636	0700077M	RES.-CARBON FLM 1/6W 560K Ω
R1637	0700047M	RES.-CARBON FLM 1/16W 3.3K Ω
R1638	0700043M	RES.-CARBON FLM 1/16W 1.5K Ω
R1639	0700059M	RES.-CARBON FLM 1/16W 27K Ω
R1640	0700054M	RES.-CARBON FLM 1/16W 10K Ω
R1641	0700027M	RES.-CARBON FLM 1/16W 100 Ω
R1642	0700041M	RES.-CARBON FLM 1/16W 1.0K Ω
R1643	0700064M	RES.-CARBON FLM 1/16W 56K Ω
R1644	0700041M	RES.-CARBON FLM 1/16W 1.0K Ω
R1645	0700049M	RES.-CARBON FLM 1/16W 4.7K Ω
R1646	0700054M	RES.-CARBON FLM 1/16W 10K Ω
R1647	0158251	RES.-VARIABLE RV9 10K Ω
R1648	0700058M	RES.-CARBON FLM 1/16W 27K Ω
R1649	0700065M	RES.-CARBON FLM 1/16W 68K Ω

PRODUCT SAFETY NOTE: Components marked with a  have special characteristics important to safety. Before replacing any of these components, read carefully the **PRODUCT SAFETY NOTICE** of this Service Manual. Don't degrade the safety of the receiver through improper servicing

S2 SOUND SUB PWB ASS PART LIST (CMT2198-CMT2196 ONLY)

SYMBOL NO.	PART NO.	DESCRIPTION
#4501	3707211	PLASTIC RIVET (BLACK) NYLON
B4501	JK00053	S2 SOUND SUB PWB
C4501	0800015R	CAP.-ELECTRO. 10UF 16V
C4502	0800048R	CAP.-ELECTRO. 100UF 10V
D4501	2338321M	DIODE 1SS270 (TA)
D4502	2338321M	DIODE 1SS270 (TA)
E4501	2997055	7P CONNECTOR TYPE TXC
E4502	9371901	SOLDER COATED ANNEALED COPPER WIRE
Q4501	2326873R	TRS. DTC144ES
Q4502	2327773M	TRS.2SC3413
Q4503	2327773M	TRS.2SC3413
Q4504	2327773M	TRS.2SC3413
R4501	0700054M	RES.-CARBON FLM 1/16W 10K Ω
R4502	0700041M	RES.-CARBON FLM 1/16W 1.0K Ω
R4503	0700067M	RES.-CARBON FLM 1/16W 100K Ω
R4504	0700059M	RES.-CARBON FLM 1/16W 27K Ω
R4505	0700041M	RES.-CARBON FLM 1/16W 1.0K Ω
R4506	0700033M	RES.-CARBON FLM 1/16W 270 Ω
R4507	0700033M	RES.-CARBON FLM 1/16W 270 Ω
R4508	0700041M	RES.-CARBON FLM 1/16W 1.0K Ω
R4509	0700027M	RES.-CARBON FLM 1/16W 100 Ω
R4510	0700027M	RES.-CARBON FLM 1/16W 100 Ω

HITACHI

HITACHI LTD. TOKYO JAPAN
International Sales Division,
THE HITACHI ATAGO BLDG.
No. 15 -12 Nishi-Shinbashi, 2 - Chome,
Minato-Ku, Tokyo 105, Japan
Tel. Tokyo 3 32581111

HITACHI SALES EUROPA GmbH
Am Seestern 18,
40547 Düsseldorf,
Germany
Tel. 0211 5291 50

HITACHI SALES (HELLAS) S.A.
91, Falirou Street, 117-41 Athens,
Greece
Tel. 92 42-620-4

HITACHI HOME ELECTRONICS (EUROPE) Ltd.
Hitachi House, Station Road, Hayes,
Middlesex UB3 4DR,
England
Tel. 0181 849 2000

HITACHI SALES IBERICA, S.A.
Gran Via Carlos Tercero.101,1 -1
Barcelona 08028
Tel. 3- 330.86.52

HITACHI FRANCE (RADIO-T.V.-ELECTRO-MENAGER) S.A.
4, allée des Sorbiers,
Parc d'active de Chêne,
69671 BRON Cedex,
France
Tel. 72 14-29-70

HITACHI HOME ELECTRONICS NORDIC
Domnarvsgatan 29 Lunda, Box 62
S-163 91 Spanga,
Sweden
Tel. 08 621 8250

**Scan & PDF-Design: Schaltungsdienst
Lange oHG
Verlag technische Druckschriften**

**Zehrendorfer Straße 11
D-12277 Berlin**

<http://www.schaltungsdienst.com>