

SHARP SERVICE MANUAL SERVICE-ANLEITUNG

SECCDV3750S//

S 3 B CHASSIS

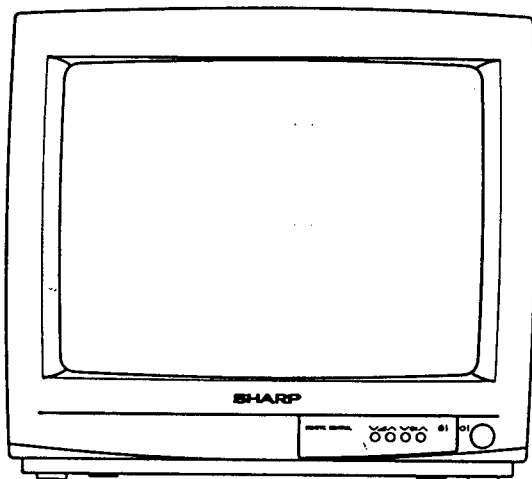

PAL/SECAM SYSTEM COLOUR TELEVISION
PAL/SECAM SYSTEM FARBFERNSEHGERÄT

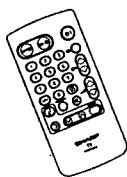

MODEL
MODELL

DV-3750S

In the interests of user-safety (required by safety regulations in some countries) the set should be restored to its original condition and only parts identical to those specified should be used.

Im Interesse der Benutzersicherheit (in einigen Länder durch Sicherheitsvorschriften gefordert) sollte dieses Gerät wieder auf seinen ursprünglichen Zustand eingestellt und nur die vorgeschriebenen Teile verwendet werden.

CONTENTS

INHALT

	Page		Seite
• ELECTRICAL SPECIFICATIONS	2	• TECHNISCHE DATEN	2
• IMPORTANT SERVICE NOTES	3	• WICHTIGE-SERVICE-HINWEISE	4
• SERVICE ADJUSTMENTS	5-8	• SERVICE-EINSTELLUNG	9-12
• CHASSIS LAYOUT DIAGRAM	13	• CHASSISANORDNUNGSPLAN	13
• PRINTED WIRING BOARDS	14-15	• LEITERPLATTENEINHEITEN	14-15
• SCHEMATIC DIAGRAMS AND WAVEFORMS	16-23	• SCHEMATISCHER SCHALTPLAN UND SIGNALFORMEN	16-23
• BLOCK DIAGRAMS	24-25	• BLOCKSCHALTPLAN	26-27
• PARTS LIST	28-36	• ERSATZTEILLISTE	28-36

SERVICE ADJUSTMENTS

IF ADJUSTMENT

1. Video Detector T 202:

1. Apply a carrier frequency of 38.9 MHz to pin ⑤ of IC 201. Connect pin ⑥ of IC 201 to ground. (Use a probe as shown in fig. 1).

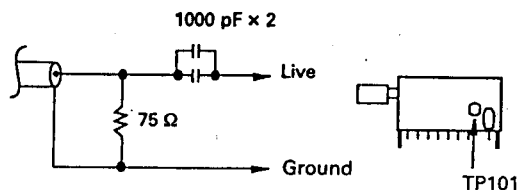

Fig. 1

2. Connect TP 208 to ground (AFT OFF).
3. Apply 4 V DC to TP 204 (Pin ② of IC 201).
4. Measure voltage at TP 203 using oscilloscope on 1 V/DIV DC range.
5. Adjust T 202 to minimum voltage.

Fine Adjustment:

6. Increase sensitivity of oscilloscope. Repeat step 5.

2. Sound Detector T 301:

1. Apply a carrier frequency of 5.5 MHz to pin ⑧ of IC 201. (Use a probe as shown in fig. 1).
2. Connect TP 301 to ground.
3. Using a DC voltmeter on the 10 V full-scale range, measure voltage at pin ⑪ of IC 201, should read 4.5 V DC approx.
4. Disconnect TP 301 from ground.
5. Adjust T 301 to obtain the same voltage as step 3.

3. AFT T 201:

1. Connect a sweep generator to Tuner TP 101. (Use a probe as shown in fig. 1).
2. Take reading at pin ⑬ of IC 201. (See waveform in fig. 2).
3. Adjust T 201 to align 38.9 MHz marker with retrace line (see fig. 2).

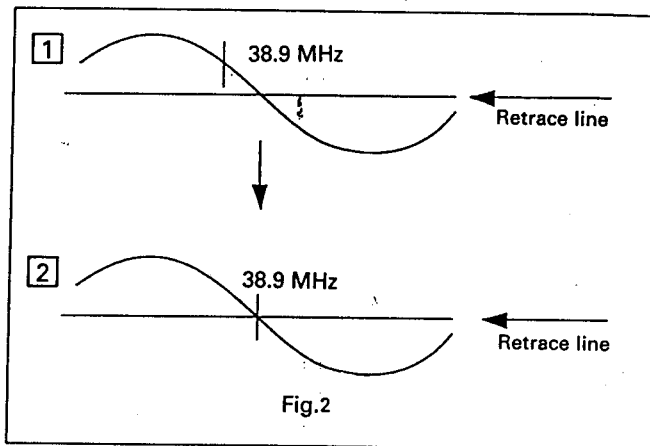

Sweep generator setting conditions.
Marker: 38.9 MHz.
Output level: 80 dB.

4. IF Adjustment:

Fine adjustment of AFT:

1. Receive colour bar signal.
2. Apply an unmodulated carrier frequency of 38.9 MHz to pin ⑧ of Tuner (IF OUT).
3. Take reading at TP 203 using oscilloscope on 1 V/DIV DC range.
4. Adjust T 201 to zero beat (see fig. 3).

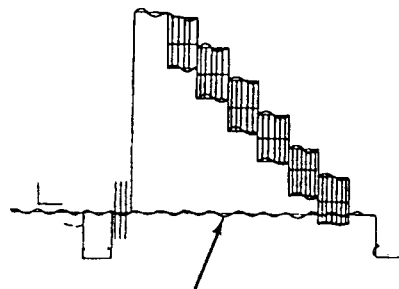

Adjust to obtain zero beat.

Fig. 3

5. RF-AGC R 208:

1. Receive colour bar signal with a level of 53 dB/ μ V (over 75 Ω).
2. Measure voltage at Tuner pin AGC using a DC voltmeter on the 10 V full-scale range.
3. Adjust R 208 to obtain the maximum voltage.
4. Readjust R 208 to 0.1 V below maximum voltage.

Screen Adjustment:

7. Focus:

1. Apply mains voltage of 220 V AC/50 Hz to TV.
2. Receive Philips pattern signal to a level between 60 and 80 dB.
3. Set contrast to 10/10, brightness to 5/10 and colour to 0/10.
4. Adjust focus potentiometer to obtain maximum definition.

8. G 2:

1. Apply mains voltage of 220 V AC/50 Hz to TV.
2. Receive black screen signal to a level between 60 and 80 dB.
3. Set contrast to 10/10, brightness to 0/10 and colour 0/10.
4. Enter into Service Mode.
5. Push CH \wedge until GII appears.
6. Increase G2 potentiometer until flyback appears on screen, and OSD bar is at maximum.
7. Adjust G2 potentiometer until OSD bar is at half way position on screen.
8. Exit Service Mode.

Power Supply Adjustment:

9. + B R 739

1. Receive monoscope pattern signal.
2. Adjust contrast control to obtain a Beam Current of 0.7 mA (0.7V between TP 601 and TP 602) set volume control to minimum.
3. Measure voltage at cathode of D 712 using a DC voltmeter on the 20 V full-scale range.
4. Adjust R 739 to obtain a voltage of 13 V DC \pm 0.05 V.

SERVICE MODE FUNCTION

This mode function is provided to assist with the settings of those adjustments that may vary from one Picture Tube to another, or between models.

In order to use the Service Mode

1. Connect Test Pattern signal to antenna terminal.
2. Connect a jump wire between terminals ② (GND) and ⑥ of the service slot situated in the Video Unit.
3. Press MODE button on R/C —SERV— will appear on screen.
4. Remove a jump wire of the service slot.
5. Select adjustment using buttons \wedge CH \vee .

	Displayed on Screen	Function
	—SERV—	Indicates operative Service Mode.
a.	HOR AM	Horizontal Amplitude (DON'T TOUCH).
b.	BL PHA	Blanking Phase shift.
c.	VER PO	Vertical position shift.
d.	VER AM	Vertical Amplitude shift.
e.	P-AMPL	Parabola Amplitude (DON'T TOUCH).
f.	VER SM	Vertical Symmetry alteration.
g.	LUMA-D	Luma Delay.
h.	P-TILT	Parabola Adjustment (DON'T TOUCH).
i.	G II	Indication of G2 adjustment.
j.	B-B-CO	Blanking Breathing Correction (DON'T TOUCH).
k.	GAIN R	Red Gain.
l.	GAIN G	Green Gain.
m.	GAIN B	Blue Gain.
n.	NVM	Access to NVM memory.

6. For "a" thru "m" Selections.

Adjustment to a selection can be made by pressing buttons \wedge \vee .

A colour bar is displayed on the OSD to indicate the adjustment position.

(MINIMUM)  (MAXIMUM)

For «n» Selection.

NVM storage location settings variants

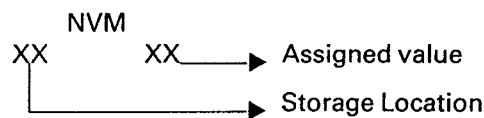

In order to have access to the desired storage location, buttons \wedge \vee should be pressed, as required, to obtain a higher or lower location, respectively. Bear in mind that, for storage location indication a hexadecimal numerical system is used, instead of a decimal system.

0, 1, 2, 3, 4, 5, 6, 7, 8, 9, A, B, C, D, E, F, 10, 11, 19, 1A, 1B, 1C, 1D, 1E, 1F, 20, 21, 99, 9A, 9B, 9C, 9D, 9E, 9F, A0, A1, B0, C0, D0, E0 F0, F1, F2, F3, F4, F5, F6, F7, F8, F9, FA, FB, FC, FD, FE, FF.

From the last location FF to the first 00 can be reached by increasing and from first to last by decreasing. Once the storage location to be varied has been selected, its value can be modified by the bits that form part of the storage location numerical buttons, numbers $\boxed{0}$ to $\boxed{7}$, respectively. This switches its binary number from and between 0 and 1 each time one of the buttons is pressed.

$$\boxed{0} = 2^0 = 1, \boxed{1} = 2^1 = 2, \boxed{2} = 2^2 = 4, \dots$$

7. The changes introduced are automatically memorized.

8. Having finalized adjustments, push MODE again to exit Service Mode.

GEOMETRY ADJUSTMENT PROCEDURE

1. "BL PHA".

- Receive Philips pattern signal.
- When \wedge button is pressed, picture moves to the left.
- When \vee button is pressed, picture moves to the right.
- Adjust the horizontal location to obtain picture centering (fig. 1).

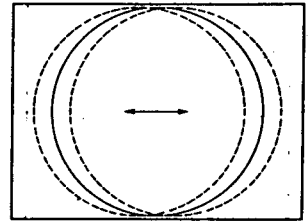

Fig. 1

2. "VER PO".

- Receive Philips pattern signal.
- When \wedge button is pressed, picture moves up.
- When \vee button is pressed, picture moves down.
- Adjust the horizontal location to obtain picture centering (fig. 2).

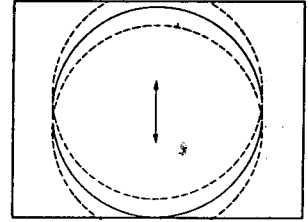

Fig. 2

3. "VER AM".

- Receive Philips pattern signal.
- When \wedge button is pressed, vertical size of picture increases.
- When \vee button is pressed, vertical size of picture decreases.
- Adjust the vertical size to obtain overscan (fig. 3).

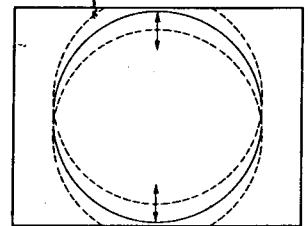

Fig. 3

4. "VER SM".

- Receive Philips pattern signal.
- When \wedge button is pressed, upper picture scanning decreases and lower picture scanning increases.
- When \vee button is pressed, upper picture scanning increases, and lower picture scanning decreases.
- Adjust the Vertical Symmetry to obtain symmetrical scanning between upper and lower picture (fig. 4).

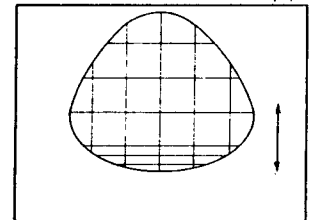

Fig. 4

COLOUR ADJUSTMENT

5. "LUMA D".

- Receive Philips pattern signal.
- When \wedge button is pressed, luma phase delays.
- When \vee button is pressed, chroma phase delays.
- Adjust the Chroma-Luma delay.

The following adjustments are only required when the Picture Tube is changed.

6-8. "GAIN R", "GAIN G", "GAIN B".

- Adjust G2.
- Tune in white card.
- Adjust colour to minimum.
- Position colourimeter in the center of screen.
- Using brightness and contrast buttons, select a luminance of ≈ 120 NITS.
- Operate again in Service Mode and select location GAIN R, GAIN G, GAIN B to obtain colour coordinates:

$$X = 0.290 \pm 0.015$$

$$Y = 0.284 \pm 0.015$$
- Exit Service Mode and check colour coordinates 'X' and 'Y' at 20 and 120 NITS. It may be necessary to repeat procedure.

NOTE:

Locations: GAIN R alter 'X' coordinate; GAIN G alter the 'Y' coordinates; GAIN B alter the 'X' and 'Y' coordinates.

SCHEMATIC DIAGRAM SCHEMATISCHER SCHALTPLAN

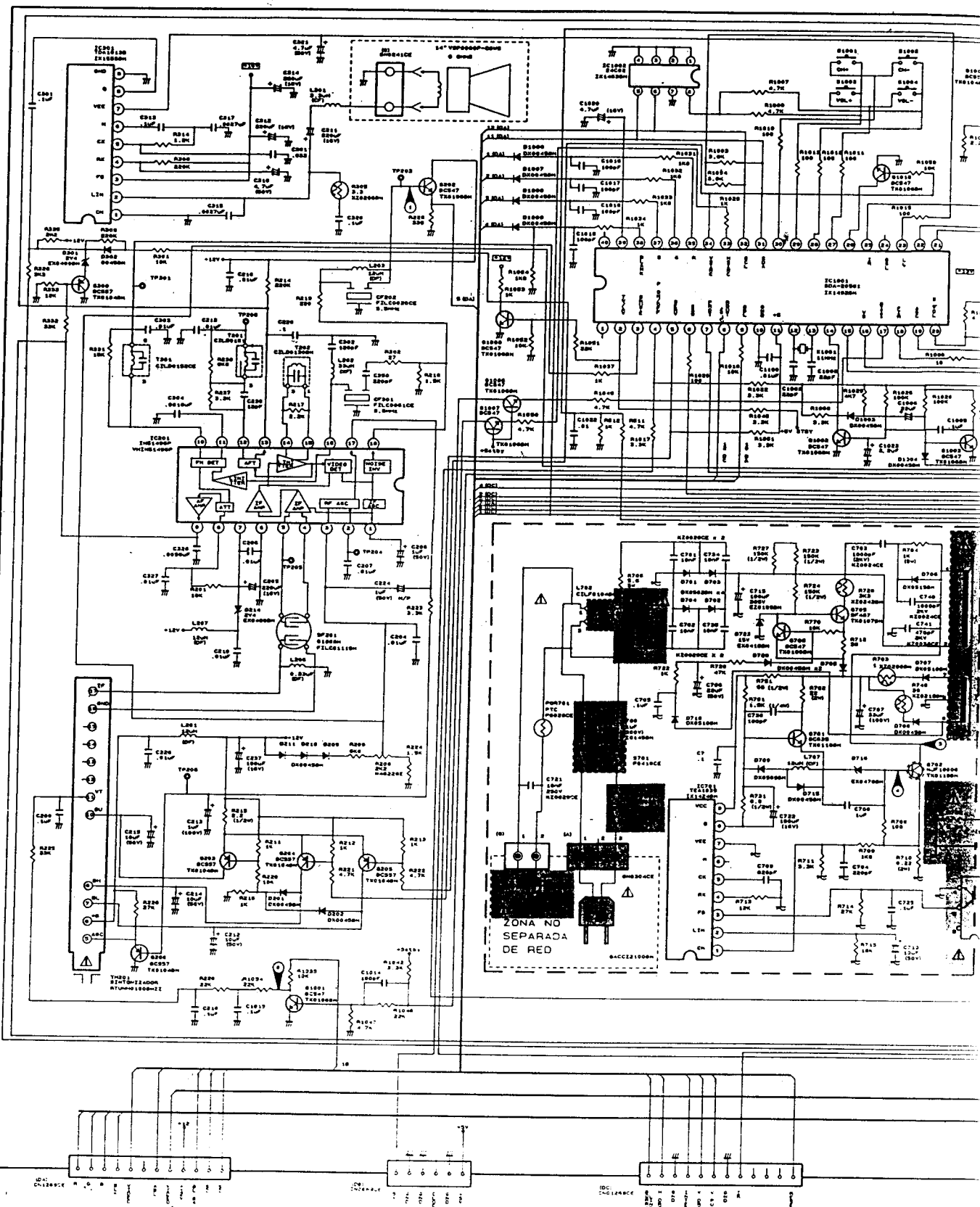

Q705 - BF487

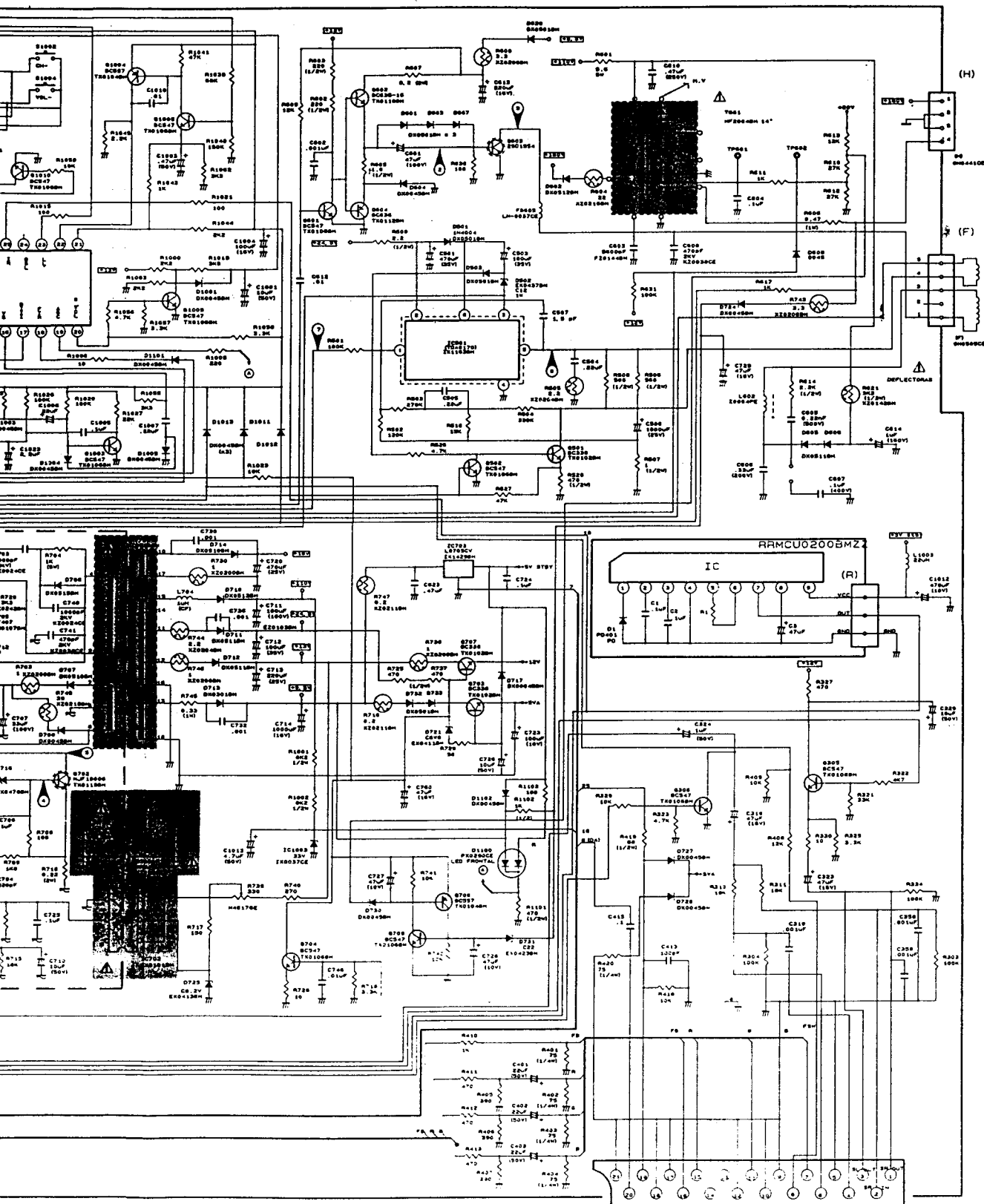

PWB-A

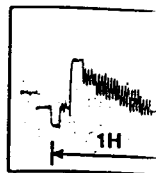

1 (2Vp-p)

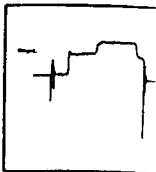

2 (4Vp-p)

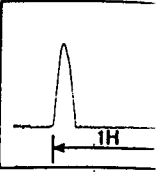

3 (980Vp-p)

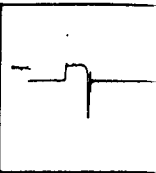

4 (15Vp-p)

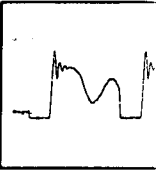

5 (768Vp-p)

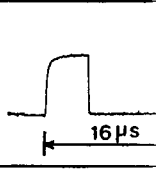

6 (16Vp-p)

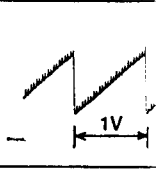

7 (1.8Vp-p)

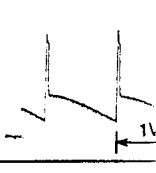

8 (50Vp-p)

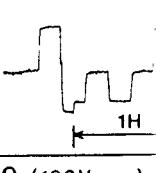

9 (100Vp-p)

SCHEMATIC DIAGRAM SCHEMATISCHER SCHALTPLAN

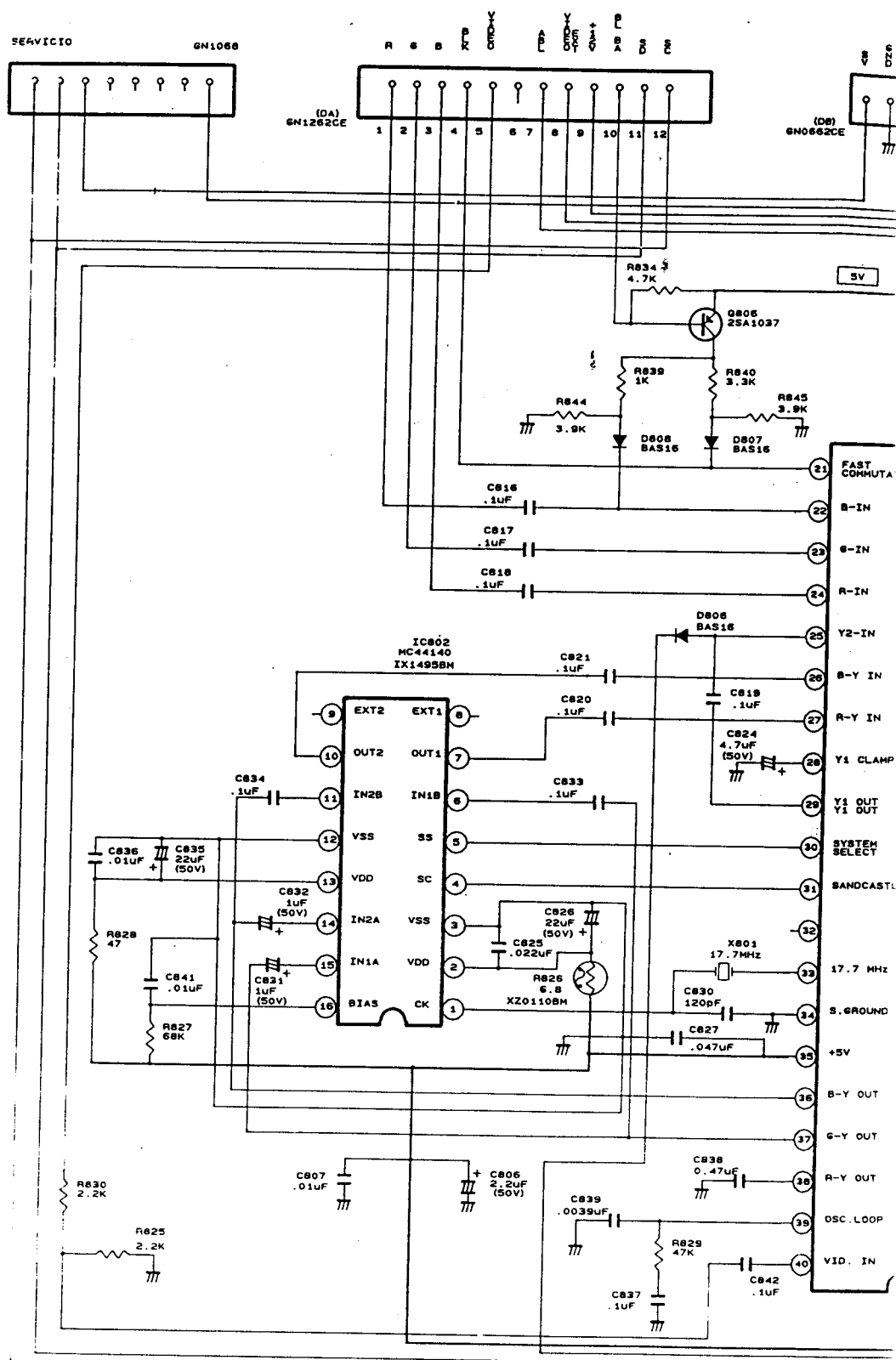

PWB-B

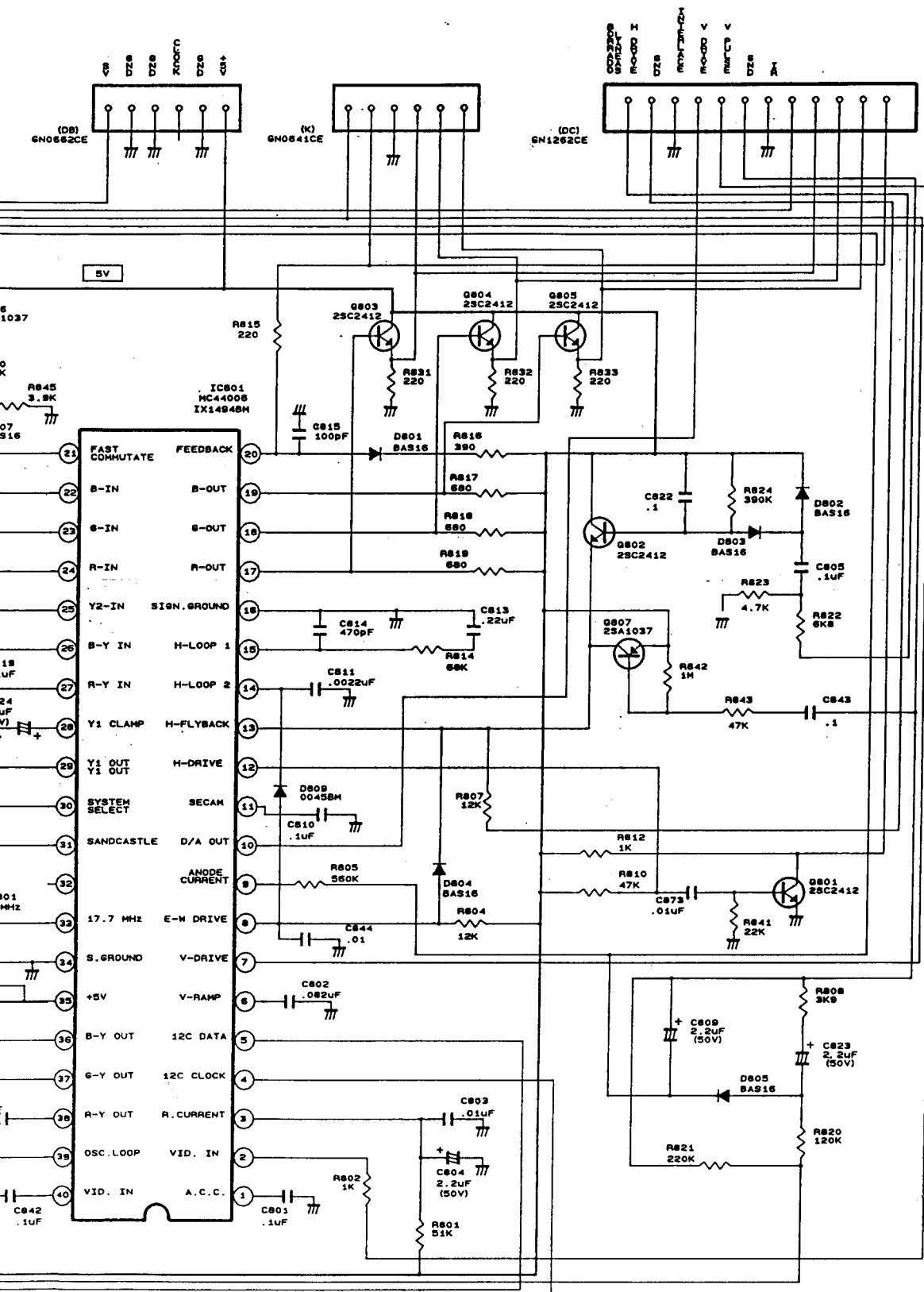

SCHEMATIC DIAGRAM
SCHEMATISCHER SCHALTPLAN

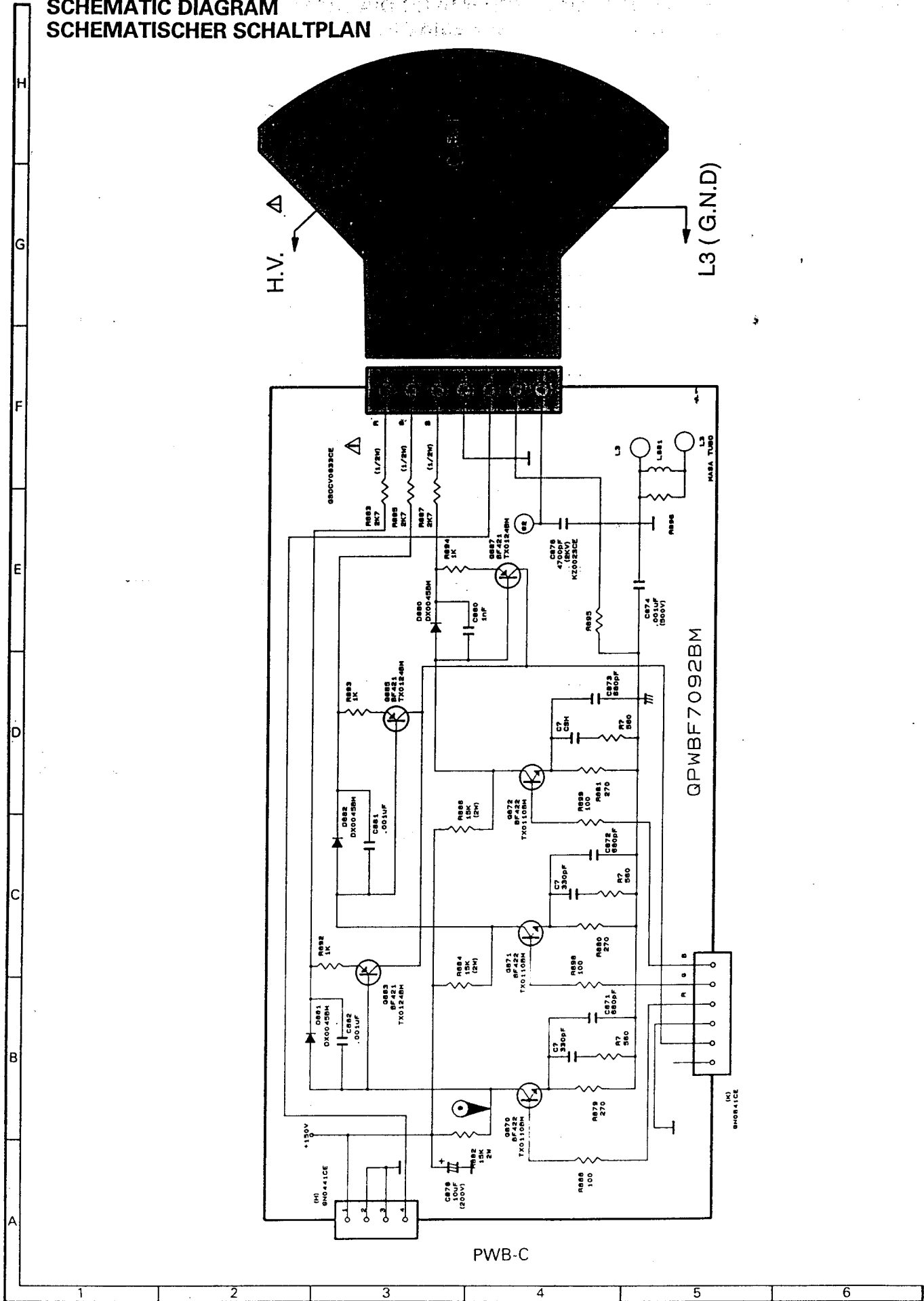

INFRARED REMOTE CONTROL UNIT SCHEMATIC DIAGRAM INFRAROTFERNBEDIENUNGSEINHEIT SCHEMATISCHER SCHALTPLAN

RRMCG1031BMSA

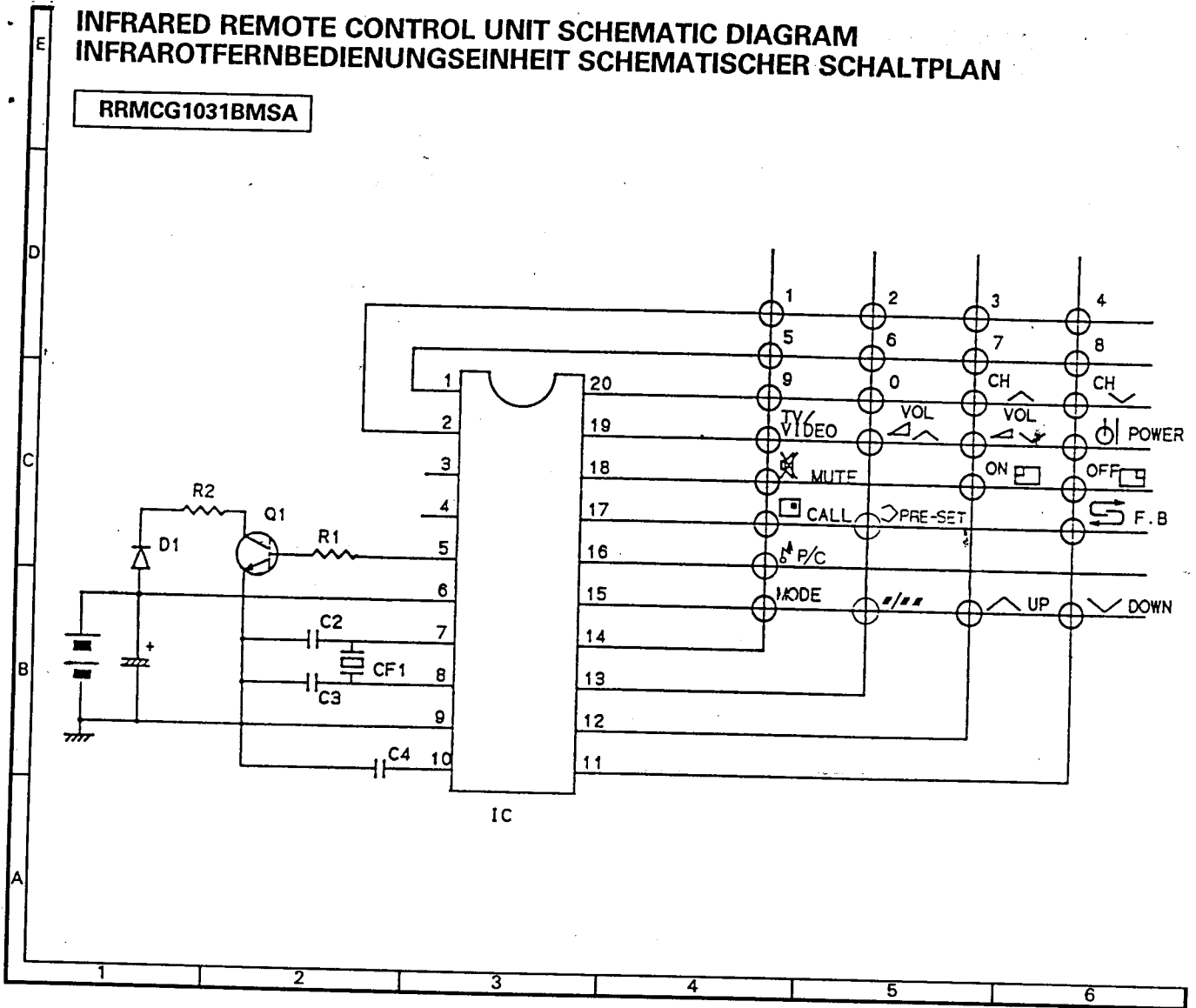

**SOLID STATE DEVICE BASE DIAGRAM
GRUNDDIAGRAM DER INTEGRIERTEN SCHALTKREISE**

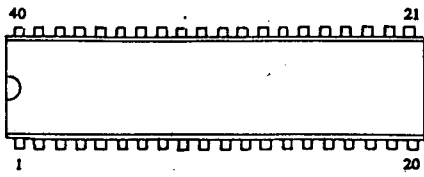

RH-IX1492BMZZ
RH-IX1494BMZZ

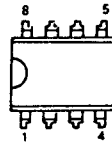

CH-IX1463CJS0

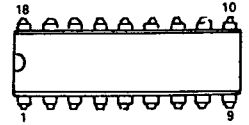

VHIM51496P/-1

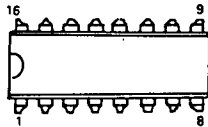

RH-IX1495BMZZ

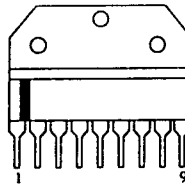

RH-IX1424BMZZ
RH-IX1555BMZZ

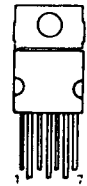

RH-IX1163BMZZ

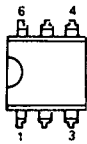

RH-FX0101BMZZ

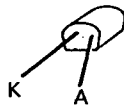

RH-IX0037CEZZ

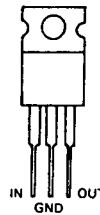

RH-IX1429BMZZ

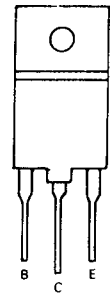

VS25D1554//2E

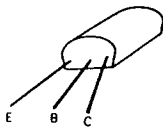

RH-TX0104BMZZ
RH-TX0102BMZZ
RH-TX0106BMZZ

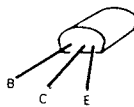

RH-TX0107BMZZ
RH-TX0110BMZZ
RH-TX0112BMZZ
RH-TX0124BMZZ
RH-TX0118BMZZ



RH-TX0119BMZZ

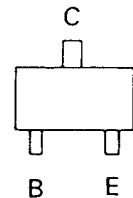

VS2SA1037KQ-1
VS2SC2412KQ-1
(SMD COMPONENT)

BLOCK DIAGRAM

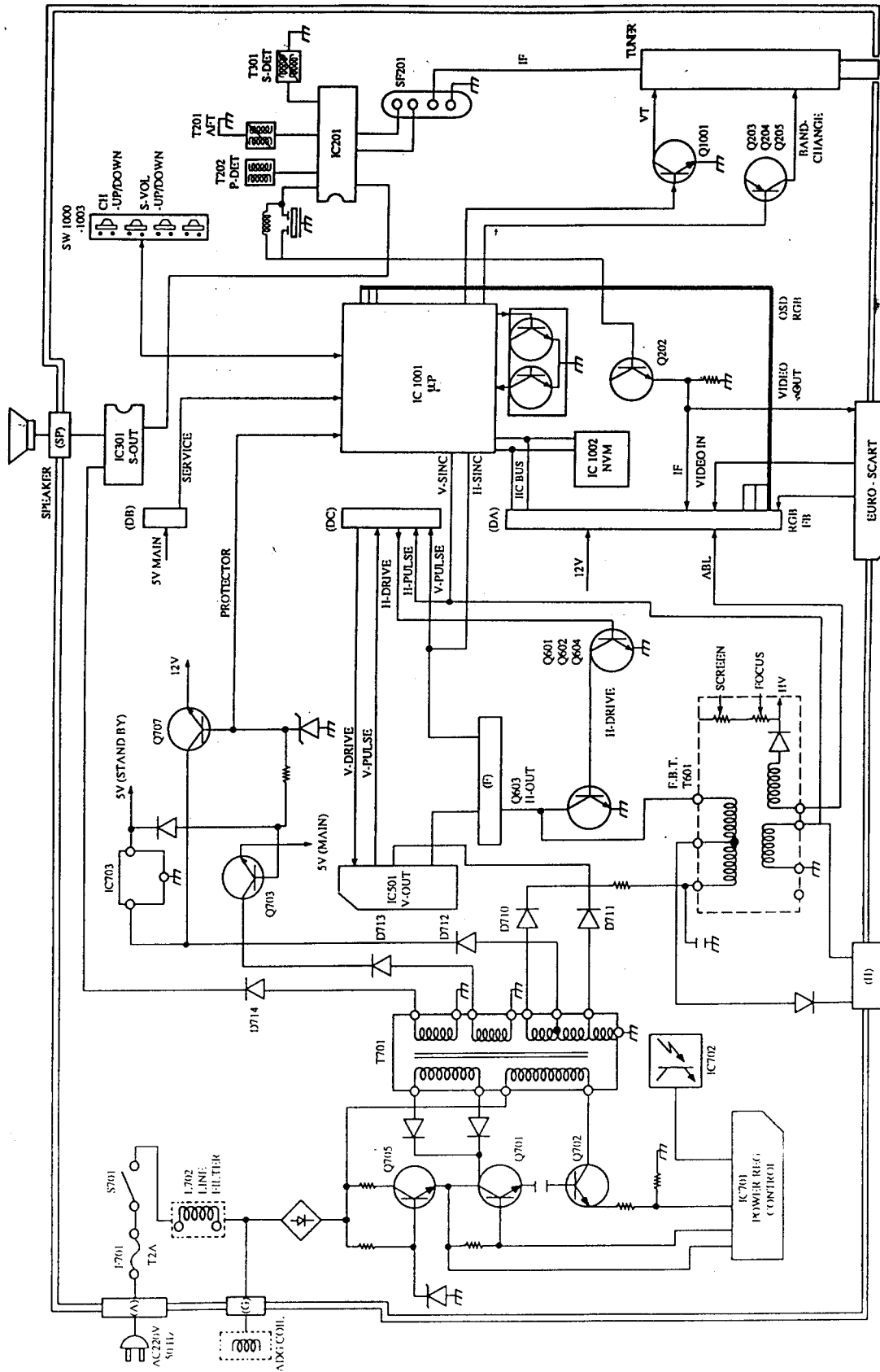

PWB-A

BLOCK DIAGRAM

