

MP3 player principle block diagram

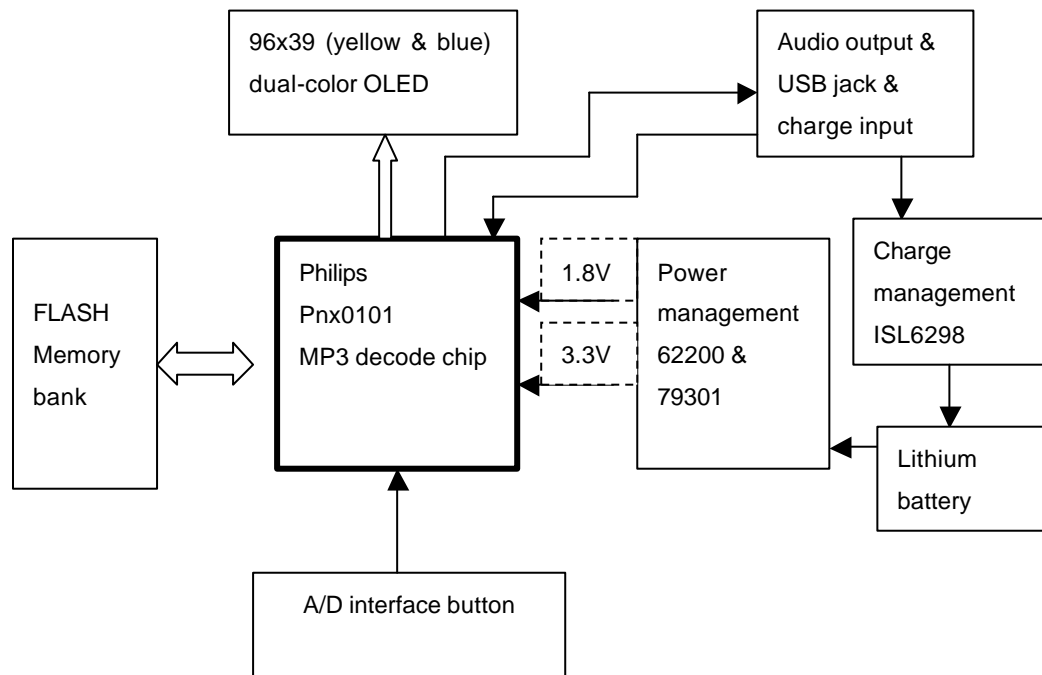

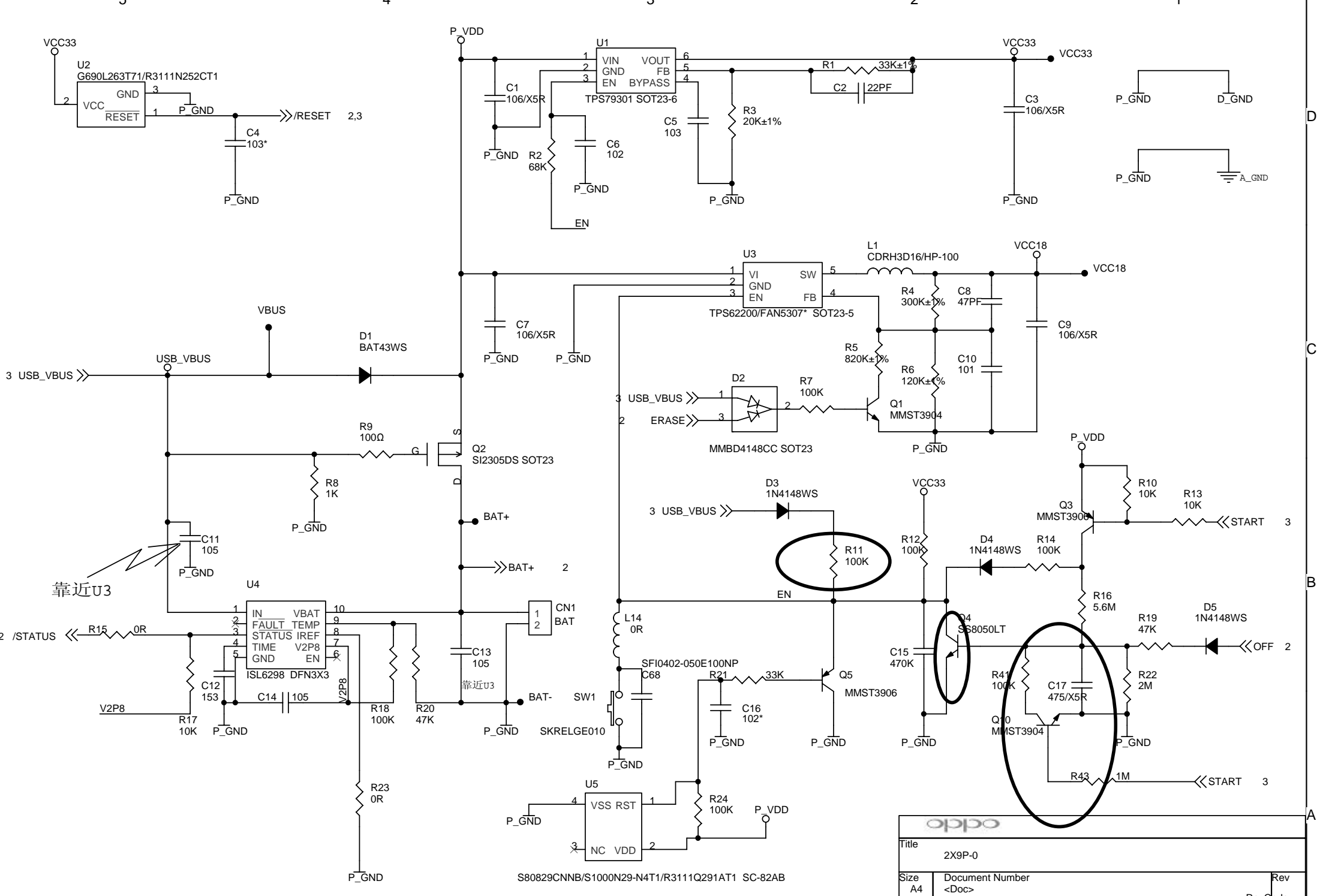

oppo		
Title 2X9P-0		
Size A4	Document Number <Doc>	Rev <RevCode>
Date: Saturday, April 23, 2005	Sheet 1	of 3

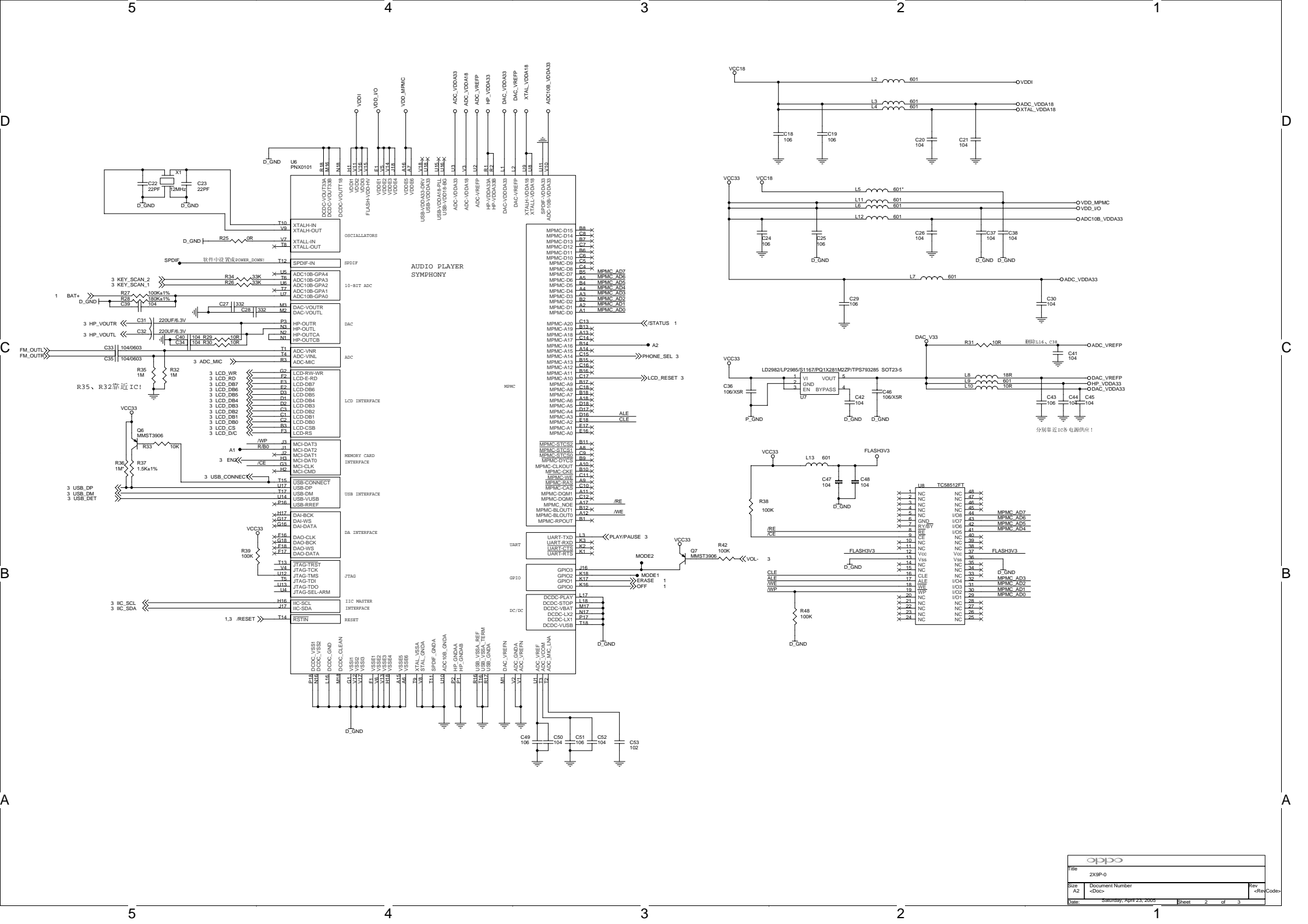

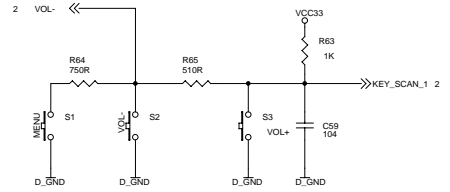
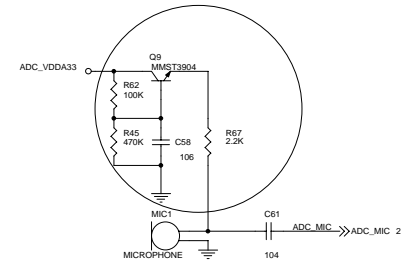
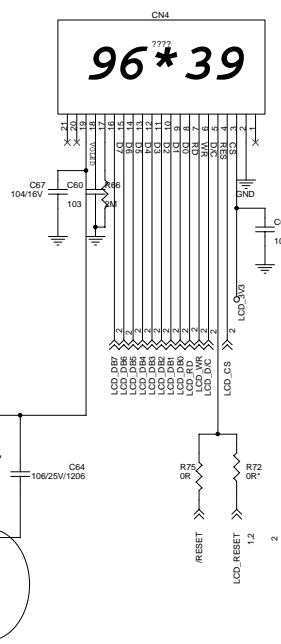
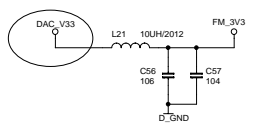
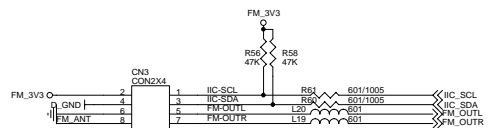
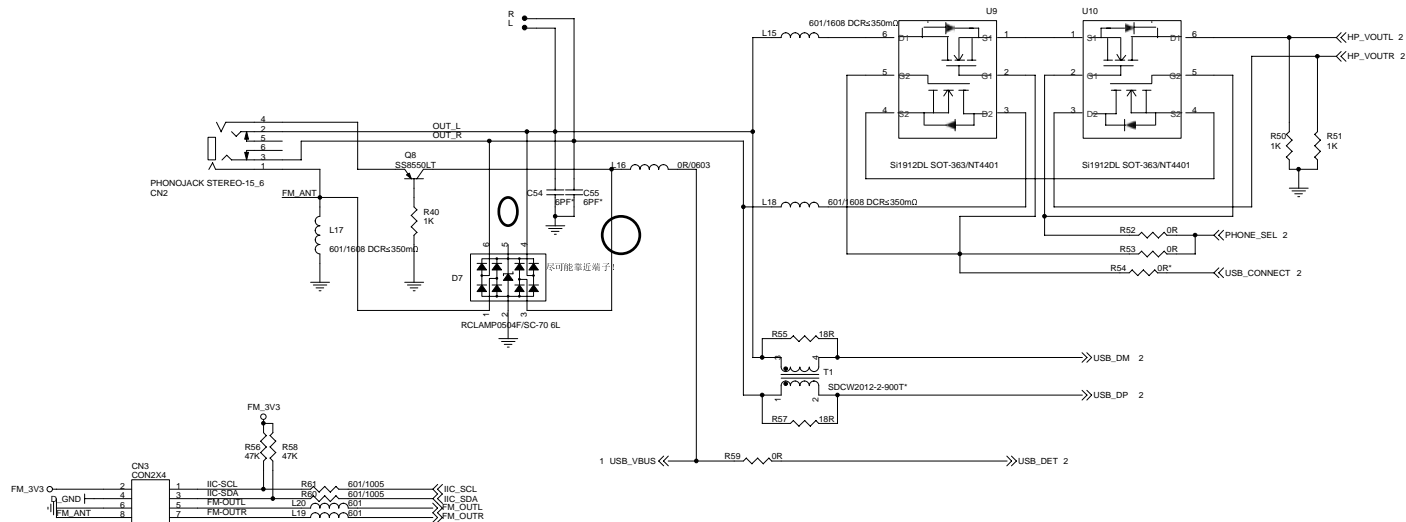

此框内电阻元件选多大阻值?

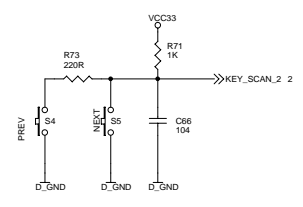
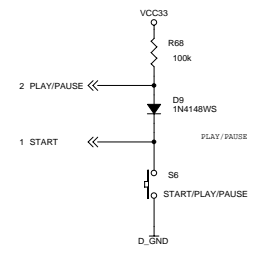

PCB另一面不要敷铜！
不要靠近晶振和IF部分（MPX等信号）
地线要干净，不要和晶振地和IF地混！

地线保持低阻抗，PCB尽可能敷铜！
不要靠近OSC和RF部分，避免强IF信号干扰OSC和RF部分。

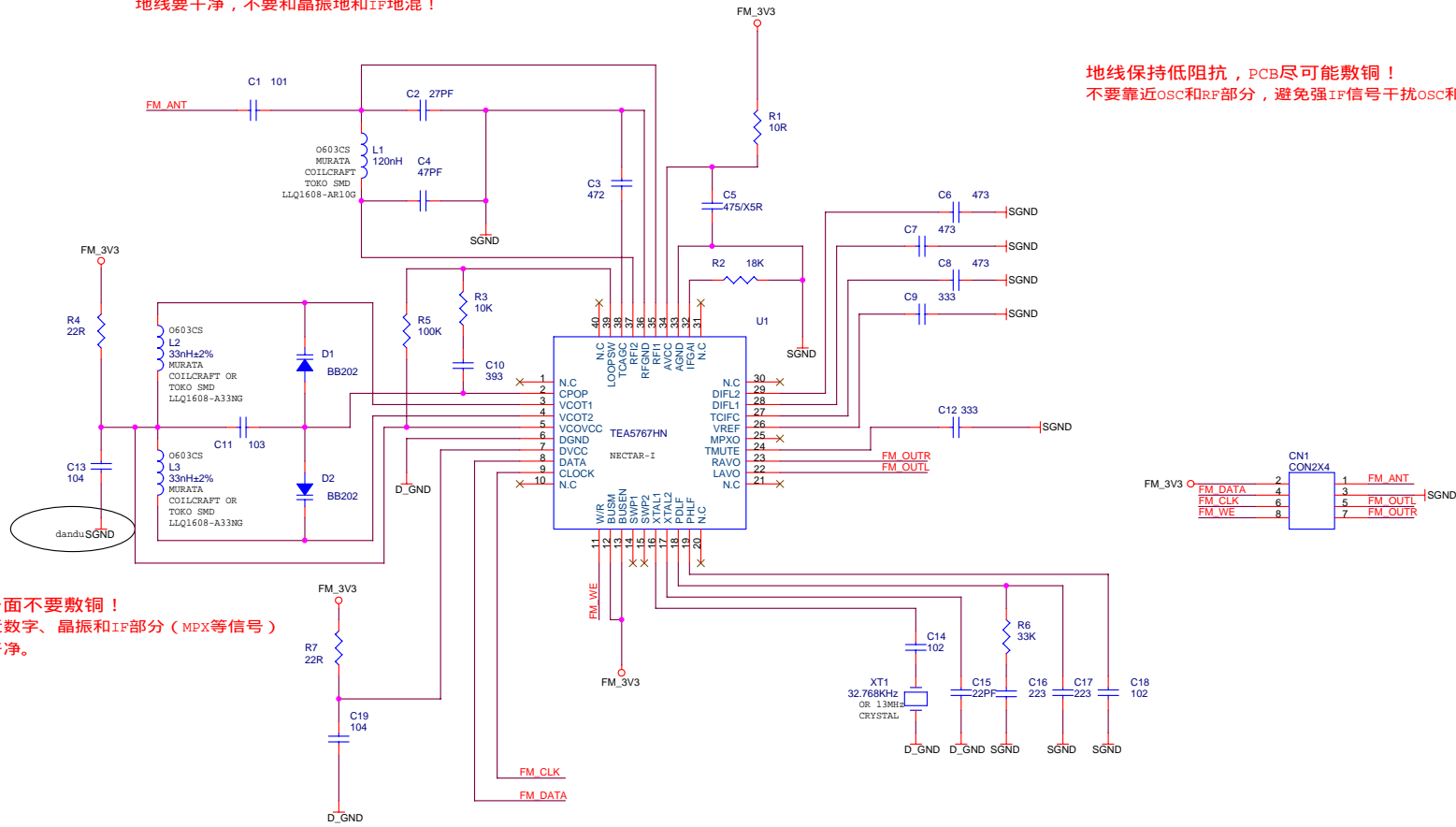

PCB另一面不要敷铜！
不要靠近数字、晶振和IF部分（MPX等信号）
地线要干净。

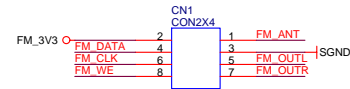

Title		
<Title>		
Size	Document Number	Rev
B	FXSS-1	1.0
Date	Saturday, March 12, 2005	Sheet 4 of 5

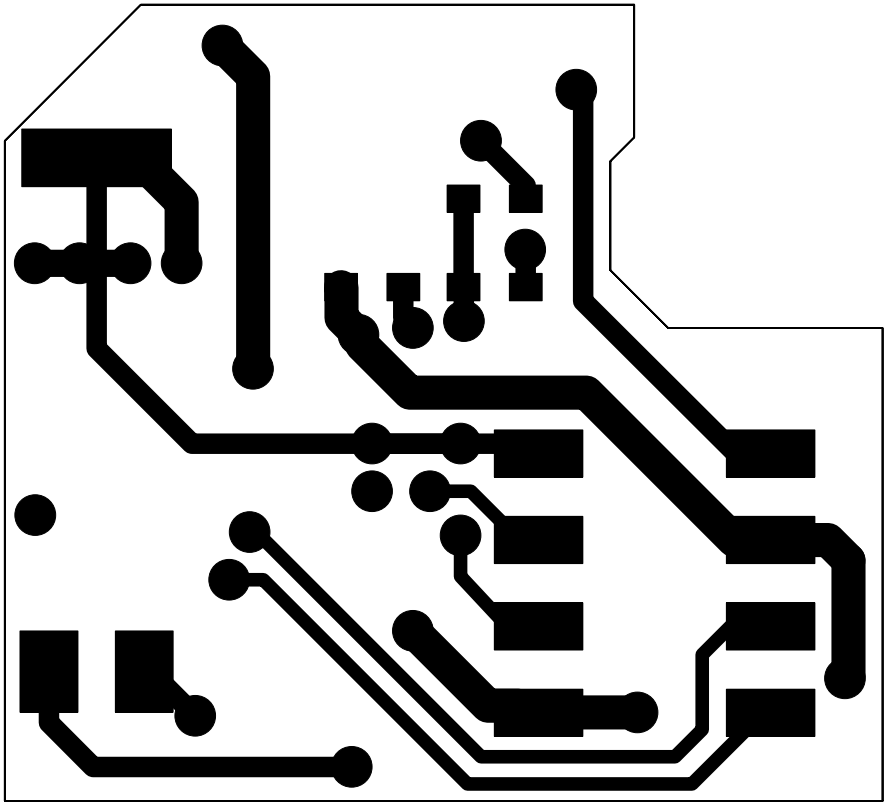

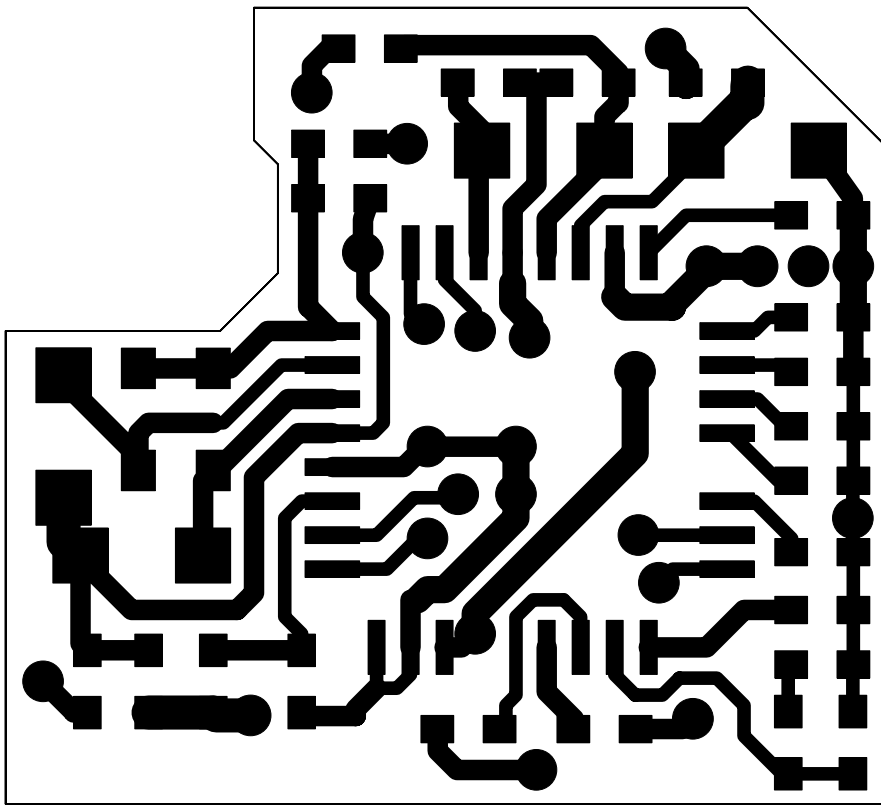

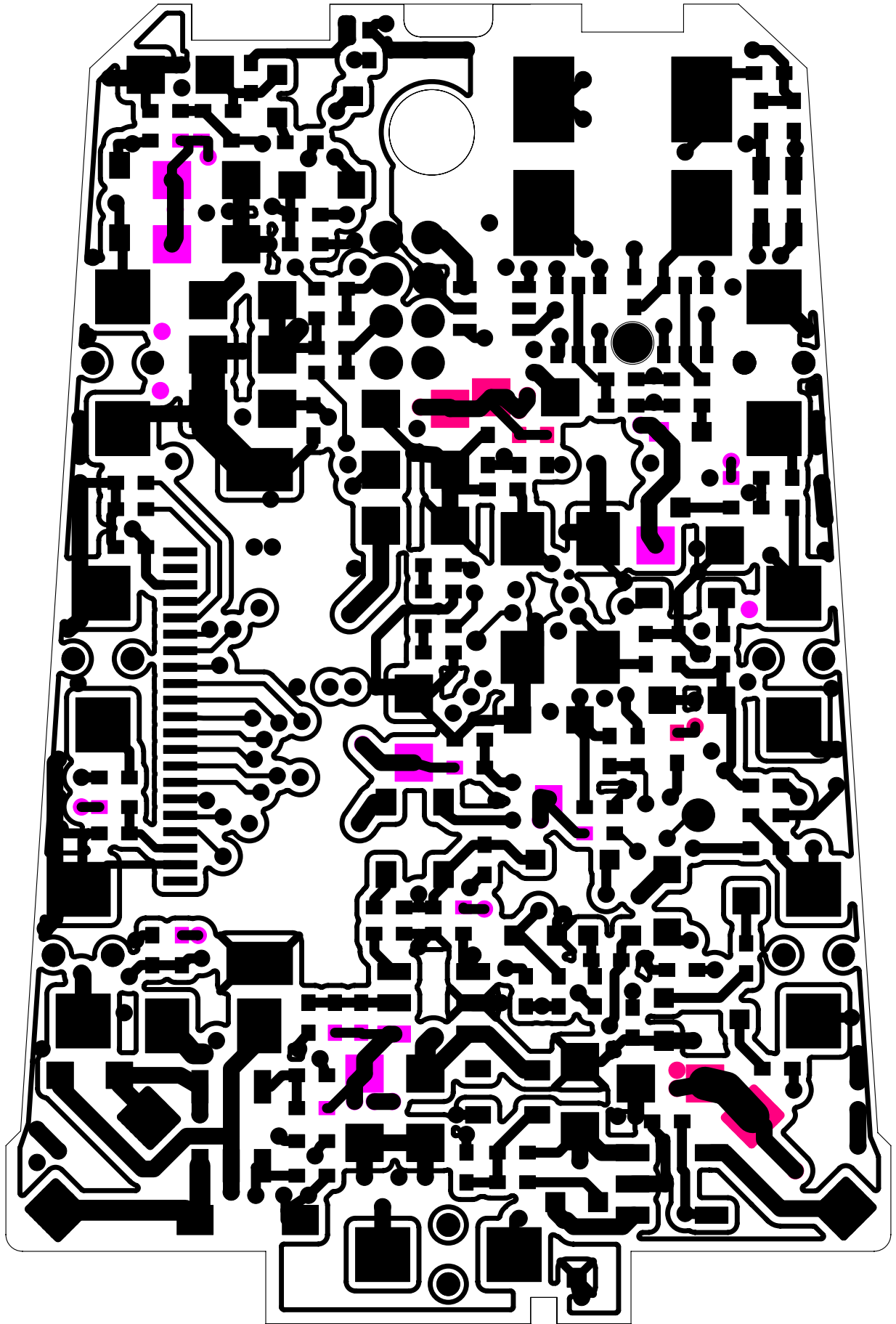

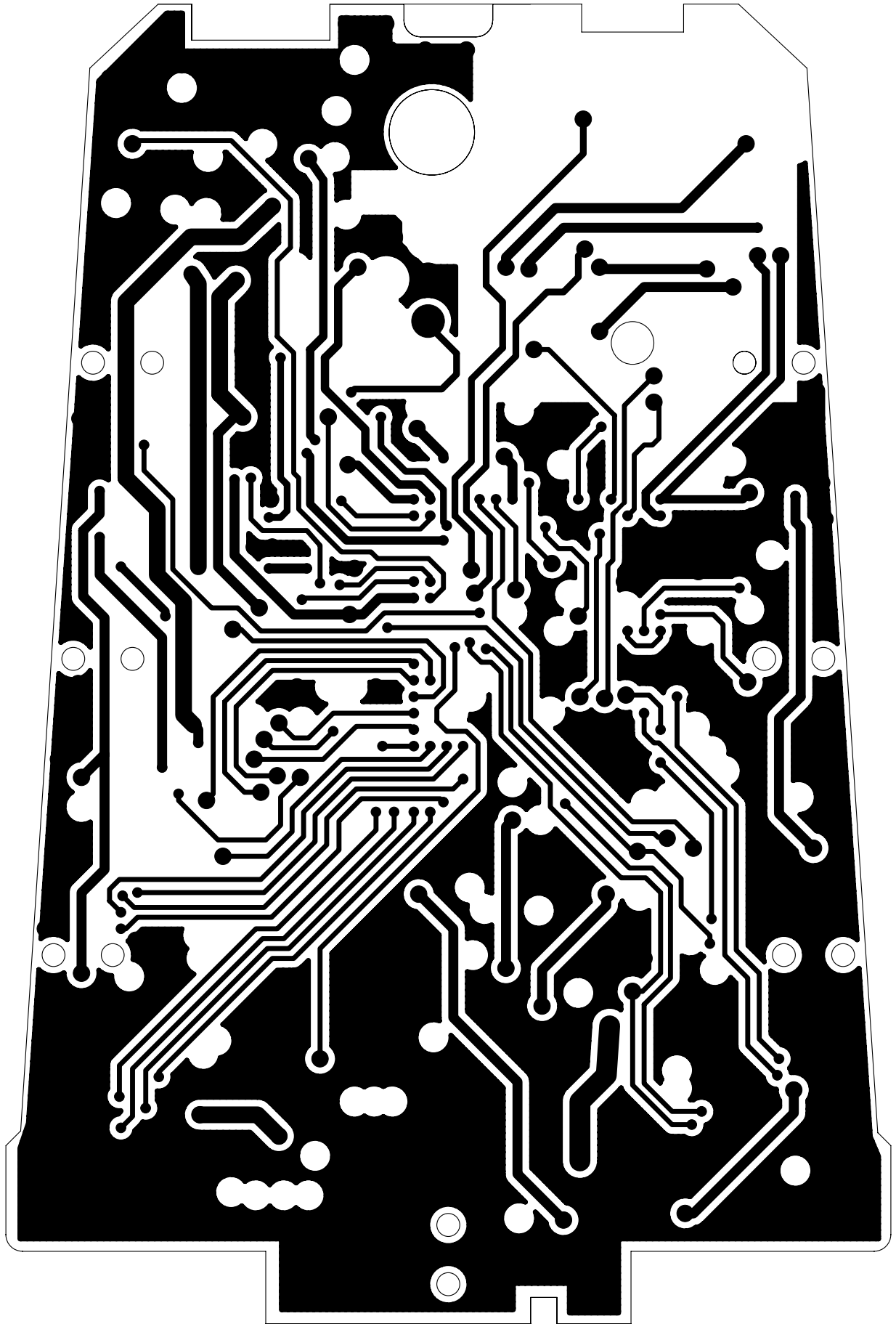

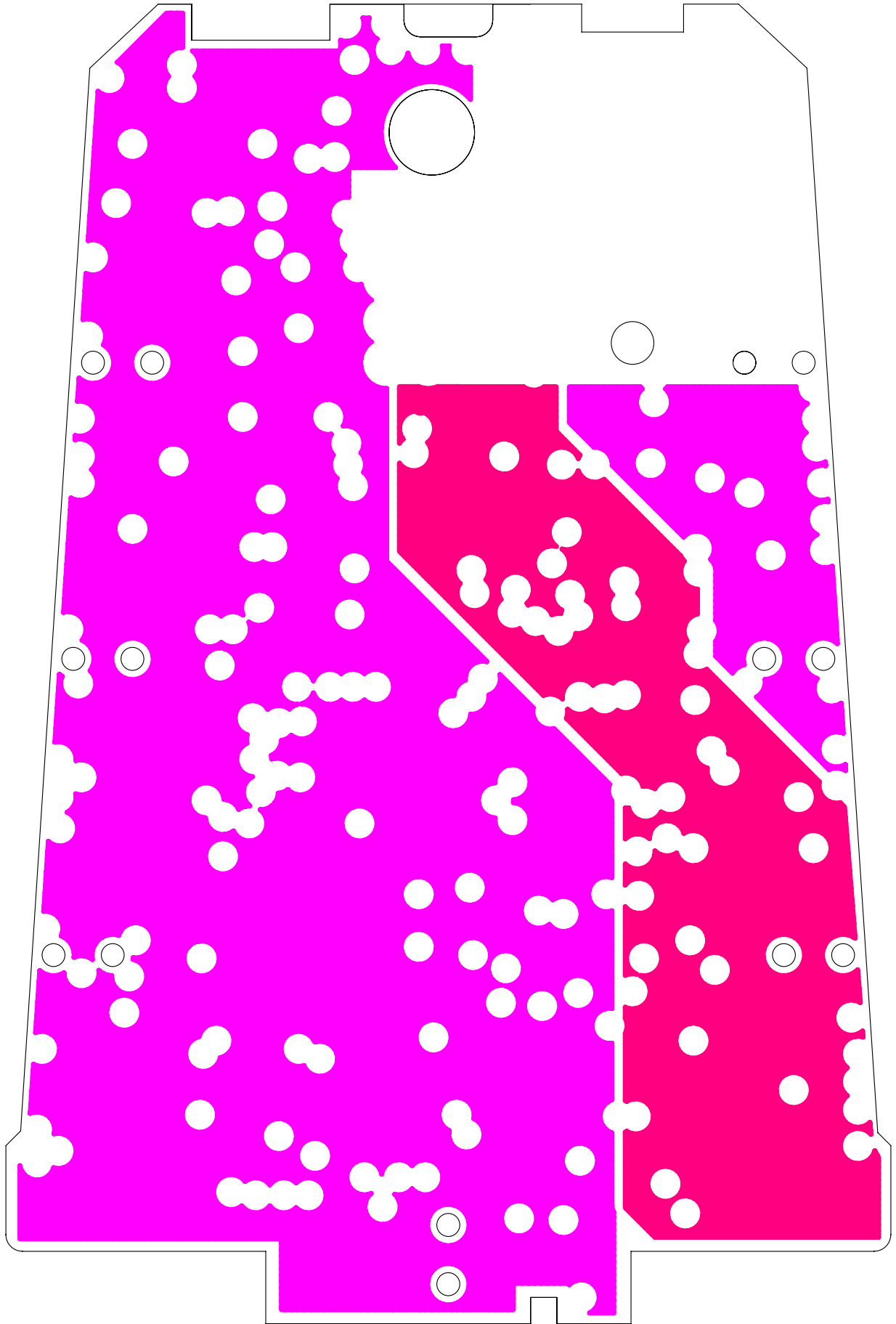

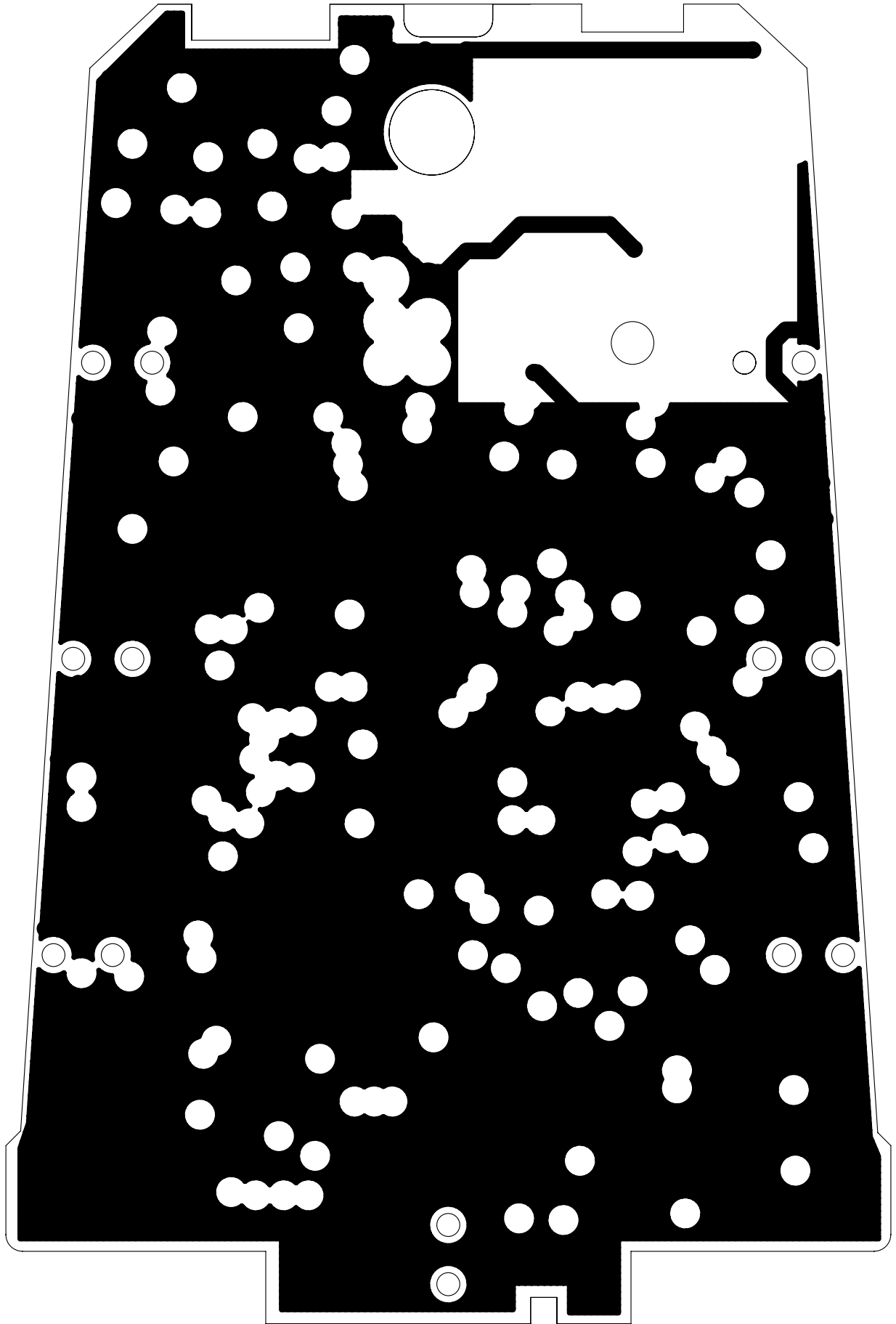

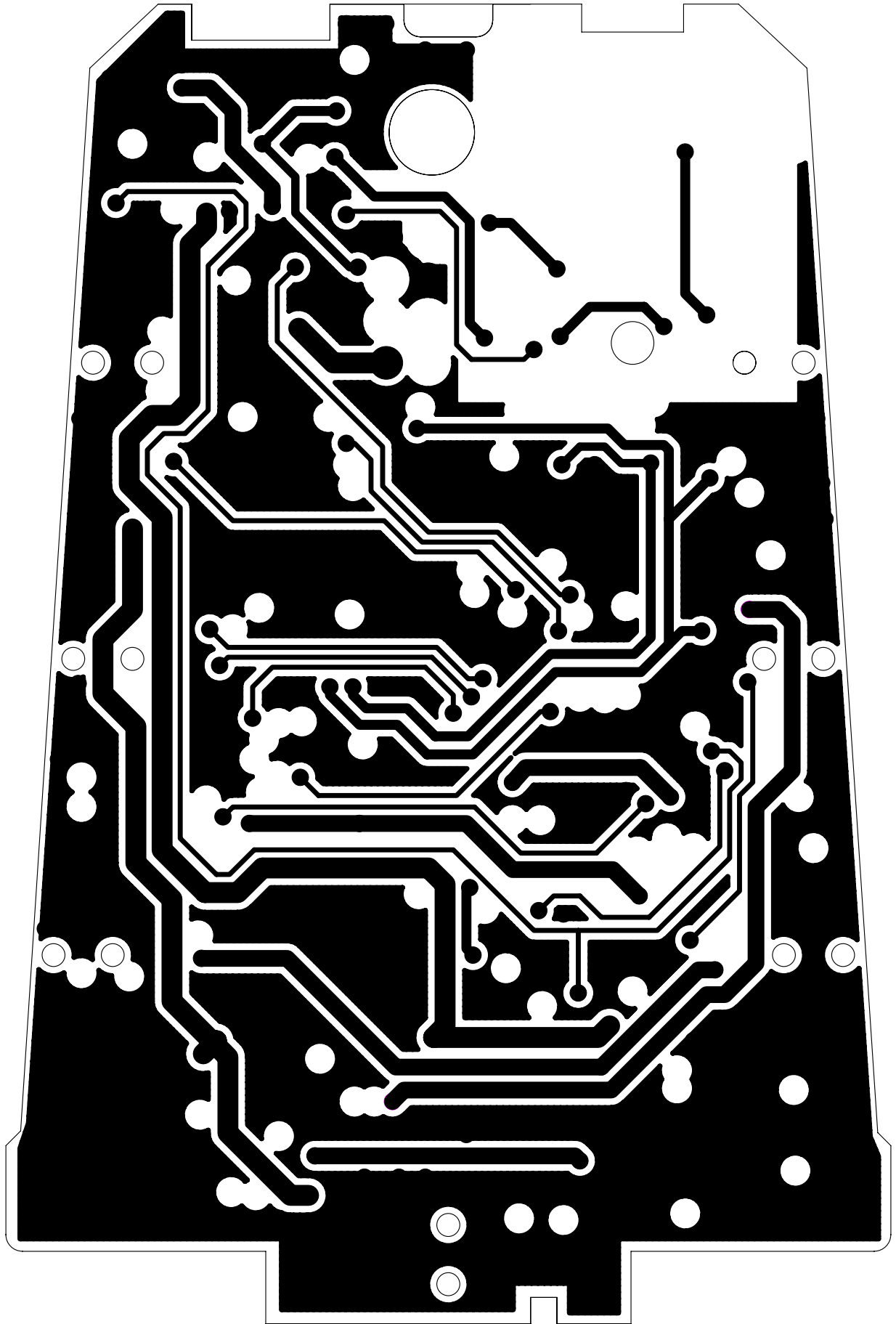

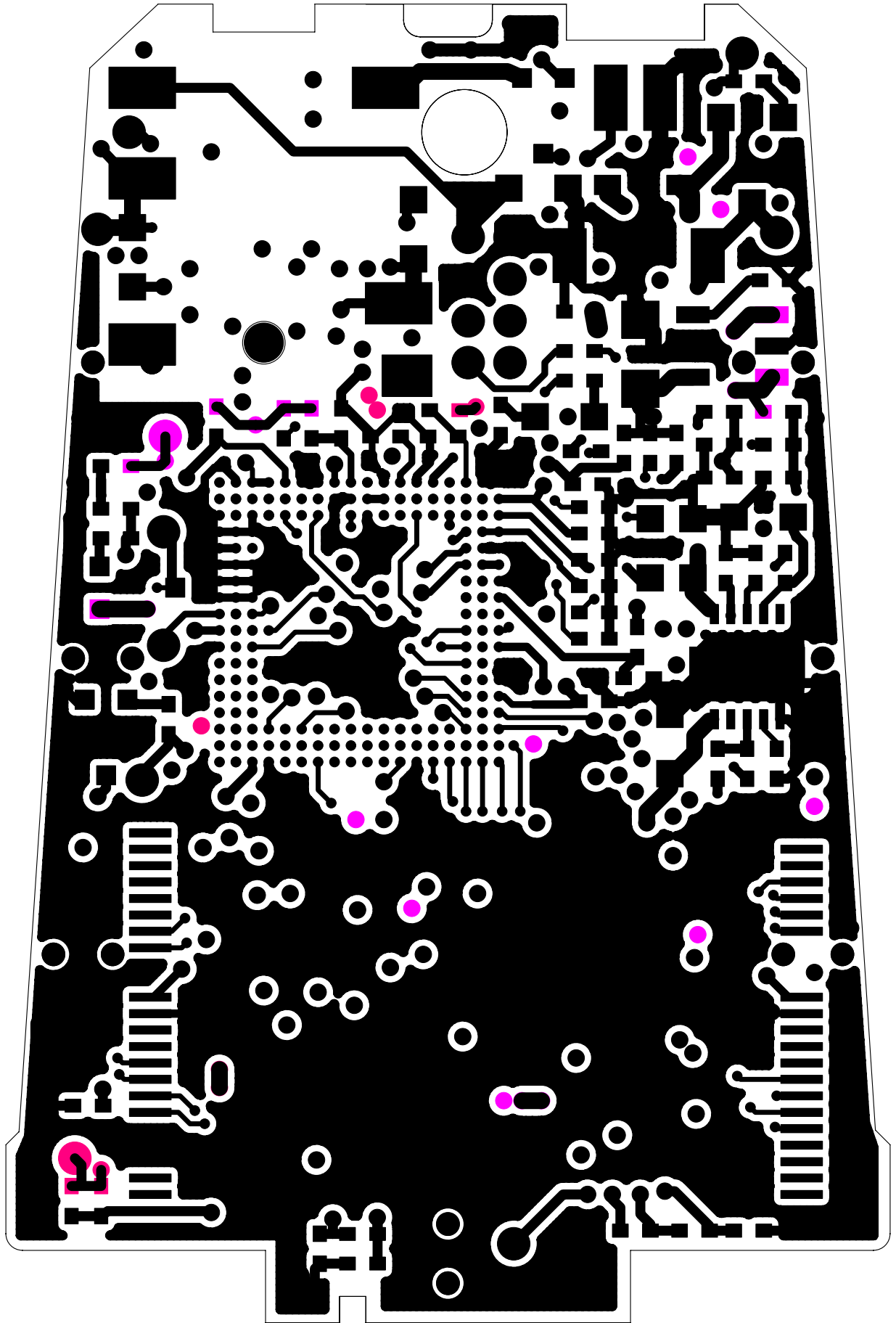

BOM List

MATERIAL CODE	MATERIAL NAME	SPECIFICATIONS	LOCATION
MAINBOARD			
0090324	SMD RESISTOR	1/16W 00±5% 0402	R15,R23,R25,R52,R53,R74,R75,L14,L30
0090326	SMD RESISTOR	1/16W 100±5% 0402	L10,R29,R30,R31
0090644	SMD RESISTOR	1/16W 180±5% 0402	R55,R57,L8
0090339	SMD RESISTOR	1/16W 100O±5% 0402	R9
0090346	SMD RESISTOR	1/16W 220O±5% 0402	R73
0090355	SMD RESISTOR	1/16W 510O±5% 0402	R65
0090359	SMD RESISTOR	1/16W 750O±5% 0402	R64
0090362	SMD RESISTOR	1/16W 1K±5% 0402	R8,R40,R50,R51,R63,R71
0090369	SMD RESISTOR	1/16W 2.2K±5% 0402	R67
0090385	SMD RESISTOR	1/16W 10K±5% 0402	R10,R13,R17,R33,R56,R58
0090396	SMD RESISTOR	1/16W 33K±5% 0402	R21,R26,R34
0090400	SMD RESISTOR	1/16W 47K±5% 0402	R19,R20
0090404	SMD RESISTOR	1/16W 68K±5% 0402	R2
0090408	SMD RESISTOR	1/16W 100K±5% 0402	R7,R11,R12,R14,R18,R24,R38,R39,R41,R48,R59,R62,R68,R69
0090425	SMD RESISTOR	1/16W 470K±5% 0402	C15,R45
0090433	SMD RESISTOR	1/16W 1MO±5% 0402	R35,R32,R43
0090436	SMD RESISTOR	1/16W 2MO±5% 0402	R22,R66
0090443	SMD RESISTOR	1/16W 5.6MO±5% 0402	R16
0090639	PRECISION SMD RESISTOR	1/16W 1.5K±1% 0402	R37
0090672	PRECISION SMD RESISTOR	1/16W 20K ±1% 0402	R3
0090671	PRECISION SMD RESISTOR	1/16W 33K ±1% 0402	R1
0090485	PRECISION SMD RESISTOR	1/16W 27K±1% 0402	R76
0090509	PRECISION SMD RESISTOR	1/16W 100K±1% 0402	R27
0090681	PRECISION SMD RESISTOR	1/16W 120K±1% 0402	R6
0090645	PRECISION SMD RESISTOR	1/16W 180K±1% 0402	R28,C69
0090682	PRECISION SMD RESISTOR	1/16W 300K±1% 0402	R4
0090687	PRECISION SMD RESISTOR	1/16W 240K±1% 0402	R70
0090684	PRECISION SMD RESISTOR	1/16W 820K±1% 0402	R5
1030029	SMD PRESS SENSITIVITY RESISTOR	SFI0402-050E100NP	C68,C70,C71,C72,C73
0310416	SMD CAPACITOR	50V 22P±5% NPO 0402	C2,C22,C23,C63

MATERIAL CODE	MATERIAL NAME	SPECIFICATIONS	LOCATION
0310424	SMD CAPACITOR	50V 47P±5% NPO 0402	C8
0310432	SMD CAPACITOR	50V 101±5% NPO 0402	C10
0310704	SMD CAPACITOR	25V 102± 10% X7R 0402	C6,C53
0310705	SMD CAPACITOR	25V 332± 10% X7R 0402	C27,C28
0310453	SMD CAPACITOR	25V 103± 10% X7R 0402	C5,C60
0310454	SMD CAPACITOR	16V 153± 10% X7R 0402	C12
0310480	SMD CAPACITOR	10V 104± 10% X5R 0402	C20,C21,C26,C30,C34,C37,C38,C39,C40,C41,C42,C44,C45,C47,C48,C50,C52,C57,C59,C62,C66,C61,R77
0310753	SMD CAPACITOR	16V 104 ± 20% X5R 0402	C67
0310703	SMD CAPACITOR	10V 105± 20% Y5V 0603	C11,C13,C14,C33,C35
0310674	SMD CAPACITOR	6.3V 475± 10% X5R 0603	C17
0310717	SMD CAPACITOR	6.3V 475± 20% X5R 0603	C65
0310486	SMD CAPACITOR	6.3V 106± 20% X5R 0805	C1,C3,C7,C9,C36,C46
0310701	SMD CAPACITOR	10V 106± 20% Y5V 0805	C18,C19,C24,C25,C29,C43,C49,C51,C56,C58
0310752	SMD CAPACITOR	25V 106± 10% X5R 1206	C64
0310702	SMD TANTALUM CAPACITOR	6.3V 220uF± 20% 6032	C31,C32
0390142	SMD MAGNETIC BEADS	FCM1608-601T02	L15,L17,L18
0090001	SMD RESISTOR	1/16W 00 ± 5% 0603	L16
0390388	SMD MAGNETIC BEADS	600O/100MHZ± 25% 1005	L2,L3,L4,L6,L7,L9,L11,L12,L13,L22,L23,L19,L20,L25,R60,R61
0390044	SMD INDUCTOR	10UH ± 10% 2012	L21
0390386	SMD CORES INDUCTOR	10uH ± 20% CDRH3D16/HP	L1
0390384	SMD CORES INDUCTOR	4.7uH ± 20% CDRH3D16-4R7	L24
0390387	SMD CORES INDUCTOR	4.7uH ± 30% CDRH3D16/HP	L24
1090080	ESD ELEMENT	RCLAMP0504F SC70-6L	D7
0700154	SMD TRIODE	1N4148WS SOD-323	D3,D4,D5,D9
0680077	SMD SCHOTTKY DIODE	MBR0520 SOD123	D8
0700057	SMD DUAL DIODE	MMBD4148CC SOT-23	D2
0680074	SMD SCHOTTKY DIODE	BAT43WS SOD-323	D1
0780298	SMD TRIODE	MMST3904 SOD-323	Q1,Q9,Q10
0780299	SMD TRIODE	SS8050LT SOD-323	Q4
0780293	SMD TRIODE	MMST3906 SOD-323	Q3,Q5,Q6
0780300	SMD TRIODE	SS8550LT SOD-323	Q8
0790041	SMD FIELD EFFECT TRANSISTOR	SI2305DS SOT-23	Q2

MATERIAL CODE	MATERIAL NAME	SPECIFICATIONS	LOCATION
0790068	SMD FIELD EFFECT TRANSISTOR	SI1912 SOT363	U9,U10
0790070	SMD FIELD EFFECT TRANSISTOR	NTJD4401N SOT363	U9,U10
0882475	IC	TPS79301 SOT23-6	U1
0882668	IC	TPS79333DBVR SOT23-5	U1
0882481	IC	G690L263T71 SOT23-3	U2
0882476	IC	TPS62200 SOT23-5	U3
0882477	IC	ISL6298-2CR3Z DFN	U4
0882524	IC	S80829CNNB SC-82	U5
0882403	IC	PNX0101ET/N302 TFBGA	U6
0882480	IC	PQ1X281M2ZP SOT23-5	U7
0882629	IC	TPS793285DBVR SOT23-5	U7
0882324	IC	K9F2G08U0M-YCBO TSOP	U8
0882576	IC	K9F2G08U0M-PIB0 TSOP	U8
0882565	IC	LM2703 SOT-23-5	U11
0882438	IC	TPS61041 SOT-23	U11
1340099	SMD LIGHT TOUCH SWITCH	SKRELGE010	SW1,S1,S2,S3,S4,S5,S6
1140070	MICROPHONE	44dB \pm 3dB 4x1.5 WITH NEEDLE	MIC1
1980074	SMD EARPHONE SOCKET	2SJ-0386-001	CN2
1970081	DUAL FLAT NEEDLE	2x4 4.5mm 1.27mm STRAIGHT INSERT,MOLD HIGH:1mm	CN3
1940282	CABLE SOCKET	21P 0.5mm SMD,SUBMIT MEET WITH CLASP	CN4
1632737	PCB	2X9P-4	
0960284	SMD CRYSTAL OSCILLATOR	12MHz \pm 30ppm 5032/4 20P	X1
BATTERY PROTECT BOARD			
0090223	SMD RESISTOR	1/16W 2K \pm 5%	R2
0090011	SMD RESISTOR	1/16W 470O \pm 5% 0603	R1
0310207	SMD CAPACITOR	50V104 \pm 20% 0603	C1,C2,C3
0310543	SMD CAPACITOR	50V 104 \pm 10% X7R 0603	C1,C2,C3
0882570	IC	S-8261AANMD-G2N-T2 SOT23-6	U1
0790065	SMD FIELD EFFECT TRANSISTOR	ECH8601 TSSOP	U2
0790090	SMDFIELD EFFECT TRANSISTOR	ECH8601R TSSOP	U2
1632263	PCB	EX9-0	
FM MODULE			
0090326	SMD RESISTOR	1/16W 100 \pm 5% 0402	R1
0090447	SMD RESISTOR	1/16W 220 \pm 5% 0402	R4,R7

MATERIAL CODE	MATERIAL NAME	SPECIFICATIONS	LOCATION
0090385	SMD RESISTOR	1/16W 10K±5% 0402	R3
0090390	SMD RESISTOR	1/16W 18K±5% 0402	R2
0090396	SMD RESISTOR	1/16W 33K±5% 0402	R6
0090408	SMD RESISTOR	1/16W 100K±5% 0402	R5
0310432	SMD CAPACITOR	50V 101±5% NPO 0402	C1
0310418	SMD CAPACITOR	50V 27P±5% NPO 0402	C2
0310706	SMD CAPACITOR	25V 472±10% X7R 0402	C3
0310424	SMD CAPACITOR	50V 47P±5% NPO 0402	C4
0310717	SMD CAPACITOR	6.3V 475±20% X5R 0603	C5
0310712	SMD CAPACITOR	10V 473±10% X5R 0402	C6,C7,C8
0310710	SMD CAPACITOR	16V 333±10% X5R 0402	C9,C12
0310711	SMD CAPACITOR	10V 393±10% X5R 0402	C10
0310453	SMD CAPACITOR	25V 103±10% X7R 0402	C11
0310480	SMD CAPACITOR	10V 104±10% X5R 0402	C13,C19
0310455	SMD CAPACITOR	16V 223±10% X7R 0402	C16,C17
0310704	SMD CAPACITOR	25V 102±10% X7R 0402	C14,C18
0310416	SMD CAPACITOR	50V 22P±5% NPO 0402	C15
0390221	SMD COIL THREAD INDUCTOR	33nH±2% 1608	L2,L3
0390398	SMD COIL THREAD INDUCTOR	120nH±2% 1608	L1
0700115	SMD TRANSFIGURATION DIODE	BB202	D1,D2
0882388	IC	TEA5767HN HVQFN	U1
1860088	FLAT FEMALE	4p 1.27mm DUAL RANK,SMD,MOLD HIGH 2.1mm	CN1
1632757	PCB	FX9P-1	
0960279	SMD CRYSTAL OSCILLATOR	32.768KHz ±20ppm SSPT6 12.5P	XT1

MATERIAL CODE	MATERIAL NAME	SPECIFICATIONS
LITHIUM BATTERY CORD UNIT		
1510166	RECHARGEABLE BATTERY	200mAh 3.7V LITHIUM 26x 24x 4.4
5446654	PCB SEMI-FINISHED PRODUCT	SEX9-0 X9
2110521	LEAD	28# 15mm BLACK
2110522	LEAD	28# 15mm RED
ASSEMBLY		
3003675	SURFACE CASING	X9 APPLE GREEN 2#
3012025	BOTTOM CASING	X9(RU)(256M) GREEN
5234193	ADHESIVE TAPE OF CONDUCT COPPER FOIL	SINGLE LEAD X9
5233899	PET INSULATED PIECE	10x2.5x0.1 SINGLE-FACED WITH GLUE IN REAR SIDE
5233982	INSULATION PLATISC BAND	WIDTH:15MM LENGTH:66M THICK:0.06MM BLACK
5234389	SOFT SPONGE SPACER	6x 4x 1.5 DOUBLE-FACED,SOFT
4720018	GLASS	X9 BLACK/LENS COVER
3871556	IRON BRACKET (LEFT)	X9 2#
3871557	IRON BRACKET (RIGHT)	X9 2#
3071006	PLAY BUTTON	X9 CHROMEPLATE 3#
3071007	NEXT BUTTON	X9 CHROMEPLATE 2#
3071008	PREV BUTTON	X9 CHROMEPLATE 3#
3071009	PATTERN BUTTON	X9 CHROMEPLATE 2#
3071011	VOLUME (-)	X9 CHROMEPLATE 2#
3071010	VOLUME (+)	X9 CHROMEPLATE 2#
3150027	FLYING RINGS	X9 CHROMEPLATE
4450047	" E' RINGS	F 2x F 4x 0.4
5233931	PORON SOFT SPACER	3x 1x 2 SINGLE-FACED WITH GLUE IN REAR SIDE
5234126	PORON SOFT SPACER	14x 1.5x 0.3 SINGLE-FACED WITH GLUE IN REAR SIDE
5233745	SOFT SPONGE SPACER	9x 8x 1 DOUBLE-FACED,SOFT
5233764	SOFT SPONGE SPACER	8x 5x 1 DOUBLE-FACED,SOFT
5233889	SOFT SPONGE SPACER	7x 7x 1 SINGLE-FACED,SOFT
4000660	SELF-TAPPING SCREW	CB1.4x5 WHITE NICKEL
1210110	OLED MODULE	SC04000344-P09103 FILM WIDTH:15.5
1210111	OLED MODULE	RGS080960390H002
5461936	LITHIUM BATTERY METAL OXIDE FILM RESISTOR CORE UNIT	200mAh 3.7V 26x 24x 4.4
5447598	PCB SEMI-FINISHED PRODUCT	2X9P-3 X9(RU)(256M)
5446655	PCB SEMI-FINISHED PRODUCT	SFX9P-1 X9

MATERIAL CODE	MATERIAL NAME	SPECIFICATIONS
PACKAGE MATERIAL		
5471439	CHARGER	@5V 300mA WITH F3.5 EARPHONE HEAD,RUSSIA CE
1150063	EARPHONE	OPPO/Sennheiser MX400 WITH EARPHONE SET
1150067	EARPHONE	Sennheiser MX400II WITH EARPHONE SET
5013506	GIFT BOX	X9(RU)
5194228	USER MANUAL	X9(RU) ENGLISH/RUSSIA
5210465	WARRANTY CARD	MP3 120x80 RUSSIA
5456376	MP3 PLAYER	X9 (RU) (256M)GREEN
3150030	HANG CHAIN	MP3(OPPO) SILVER WHITE
5070981	GLUE BAG FOR ENVIRONMENTAL PROTECTION (WITH HOLE)	145x65x0.05 PE
5002798	CARTON BOX	33x32.5x15.5CM3 X9(RU)
5180735	SEALING LABEL OF GIFT BOX	MP3 F25 ENGLISH
5155966	MODEL LABEL FOR GIFE BOX	X9(RU) GREEN
2400253	SUITABLE SOFTWARE DISC (8cm)	MP3(RU) philips
5233768	PROTECT FILM	X9
2180083	USB CORD	1.2m DOUBLE HEAD(USB MALE/F3.5)2#
5002800	CARTON BOX	63x33.5x34.5CM3 X9(RU)
5155972	PAPER BOX WITH MODEL STICKER	X9(RU) GREEN 65x38
5070954	GLUE BAG FOR ENVIRONMENTAL PROTECTION (WITH HOLE)	95x65x0.05 PE
5180752	COLOR LABEL	APPLE GREEN (COLOR) F12
5013017	INNER PAPER CSE	154x61x125 X9
5142663	SN LABEL	MP3(RUSSIA BBK) WITH BAR CODE NUMBER
5071010	DISC PACKING BAG	86x86x0.01 PE WITH HEAL GLUE 2#
5070982	DISC PACKING BAG	86x86x0.01 PE WITH HEAL GLUE
5080030	GLUE SET	X9(SILICA GEL) LIGHT GREEN
SUPPLEMENT MODULE		
5233646	RESIST HIGH TEMPERATURE INSULATING TAPE	LENGTH:33m WIDTH:6mm
5120754	GLUEWATER	LOCTITE 3517
5120592	3M GLUEWATER	DP460(37ML)
5120761	AID WELDING GREASE	MC40
SN LASEL		
5142067	SN LABEL	RUSSIA WITHOUT BAR CODE NUMBER