

Service
Service

Service Manual

PROLOGY

SET BLOCK DIAGRAM

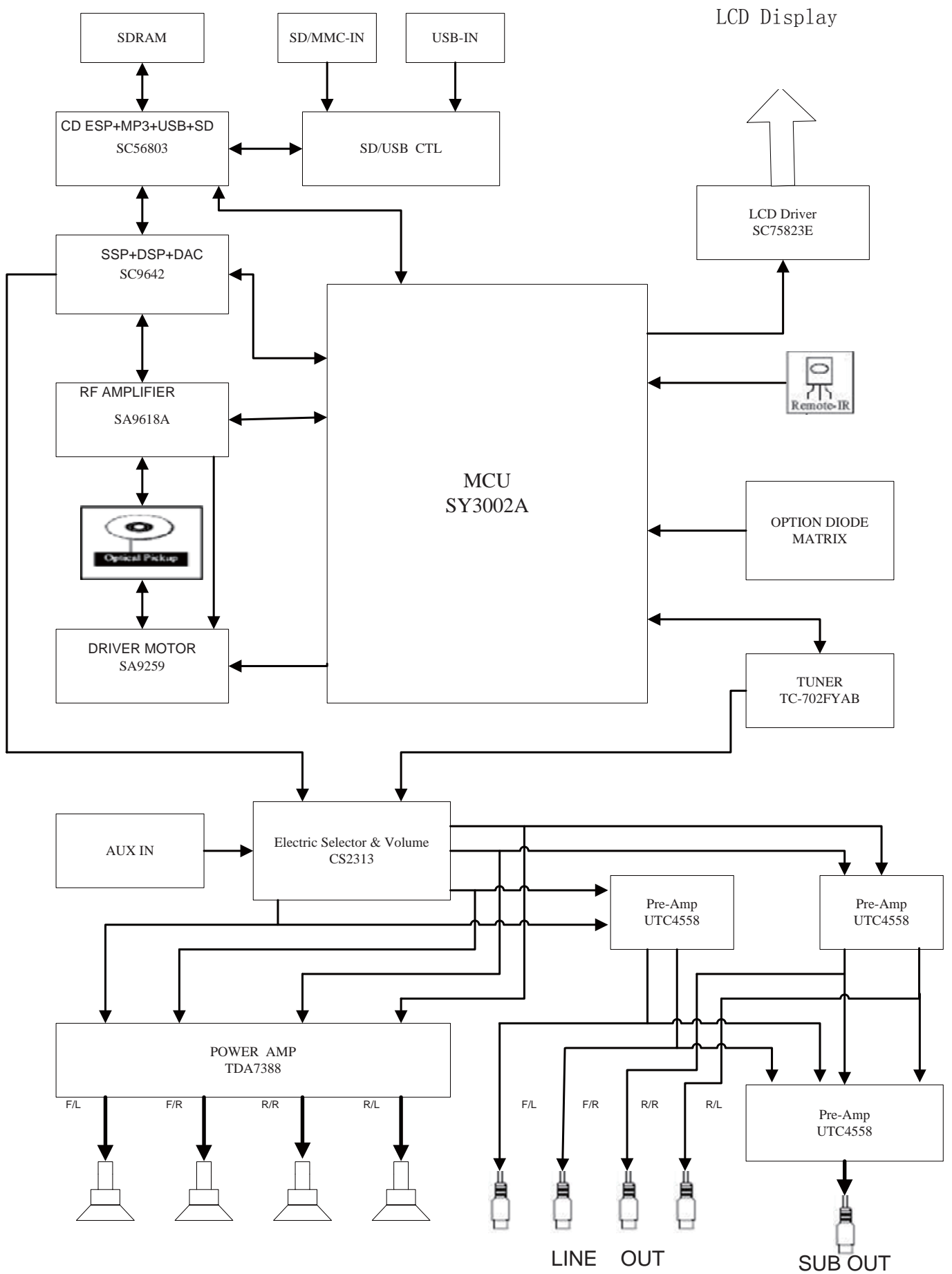

MAIN BOARD - CIRCUIT DIAGRAM

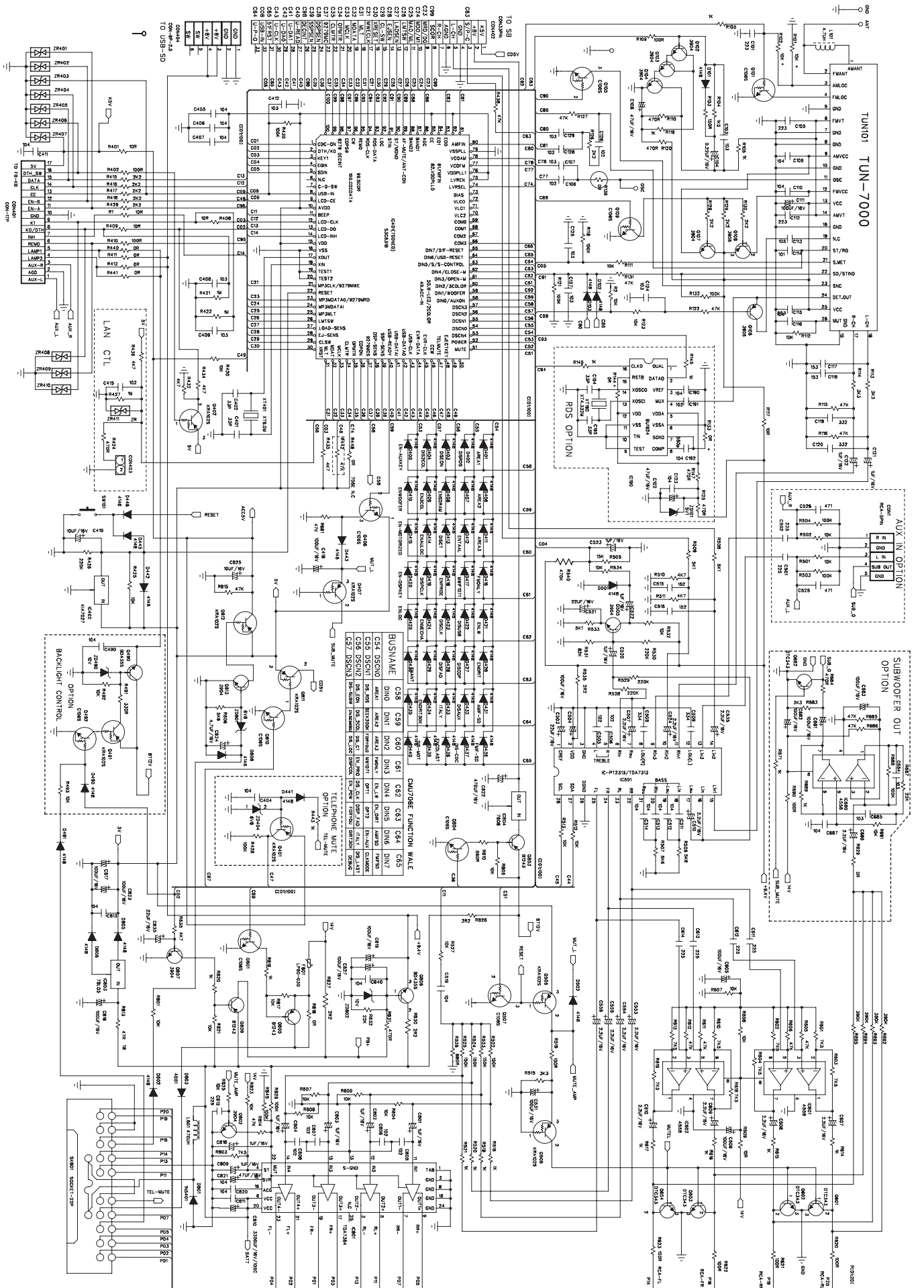

MAIN BOARD - PCB LAYOUT TOP VIEW

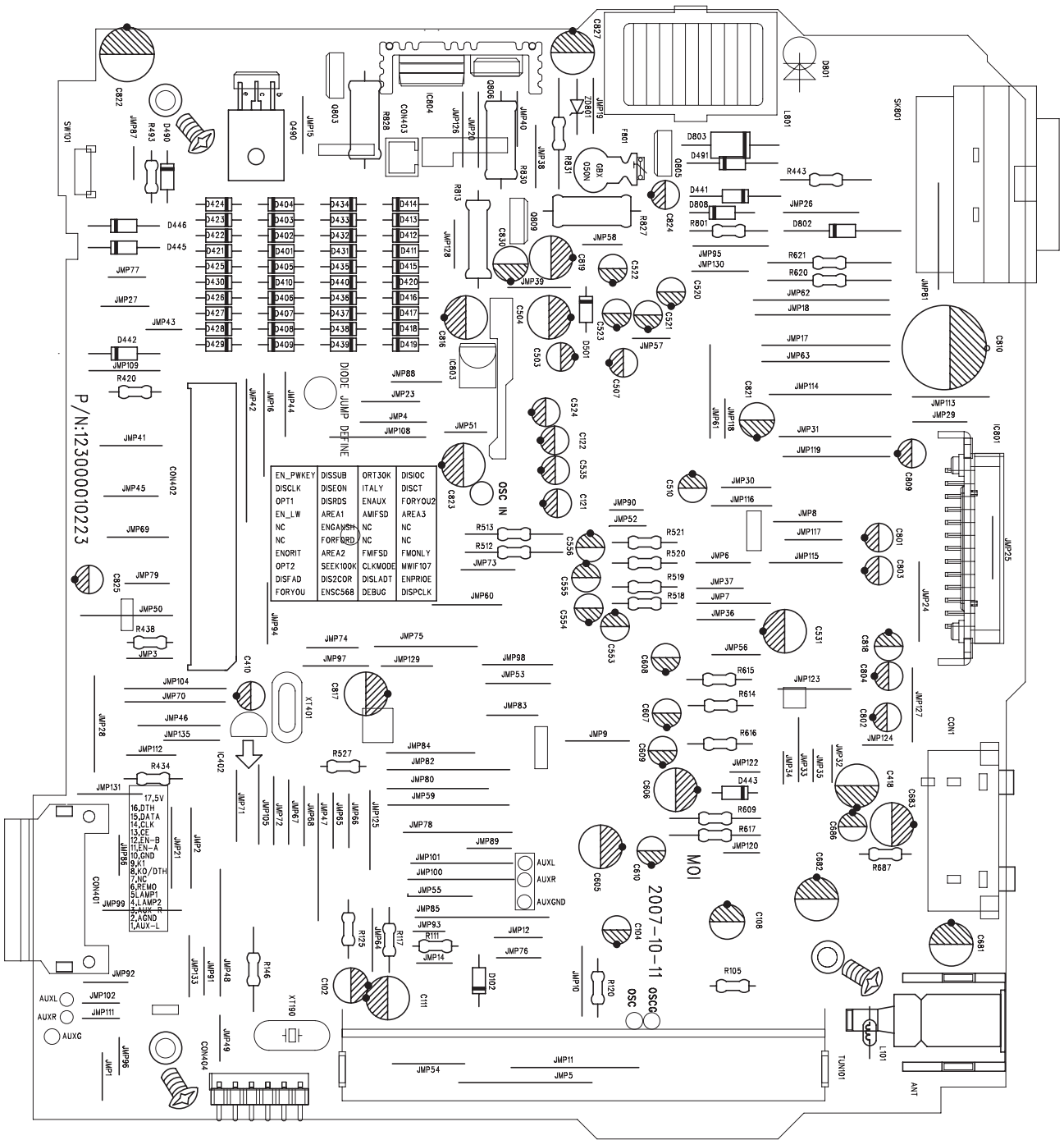

MAIN BOARD - PCB LAYOUT BOTTOM VIEW

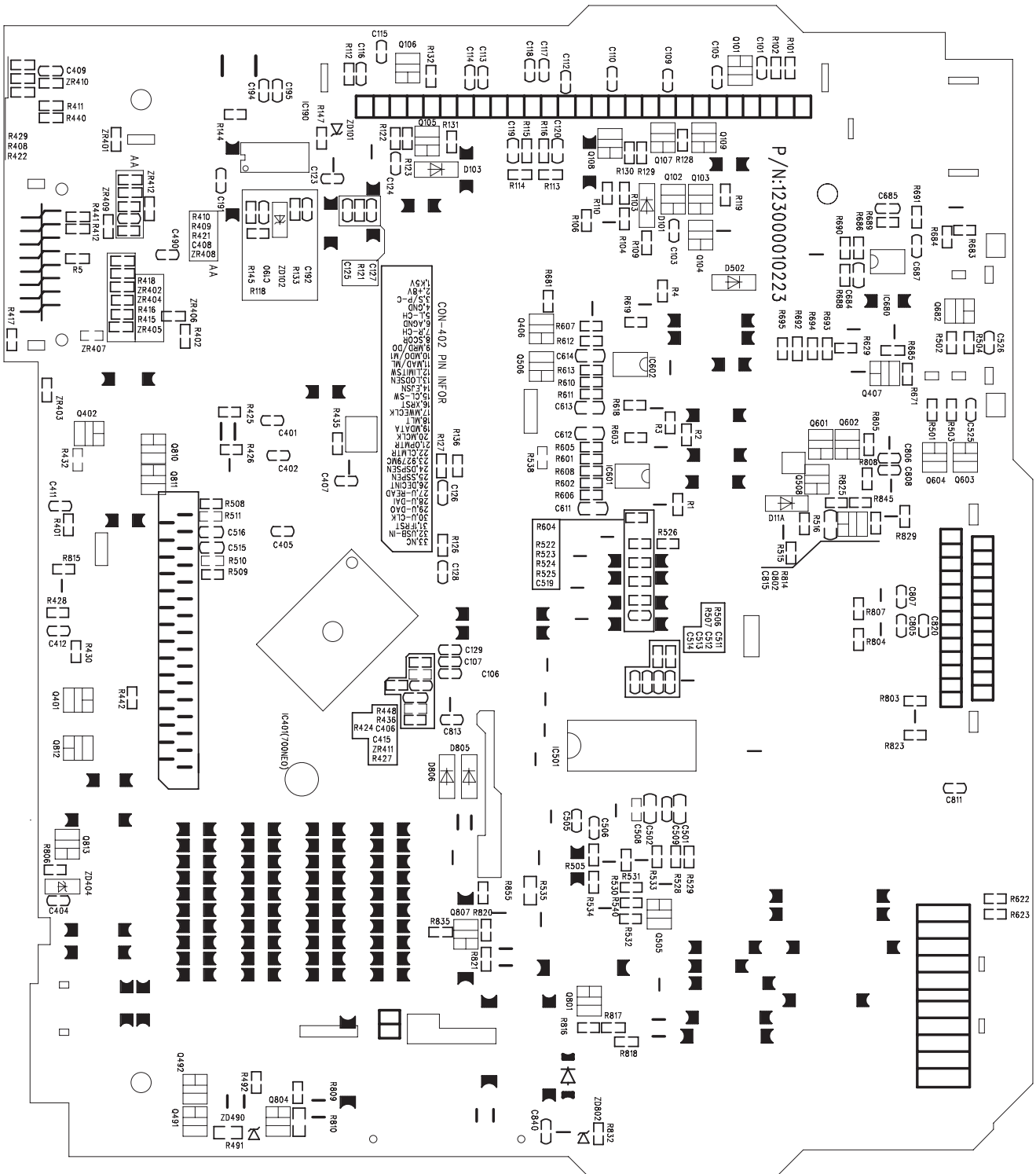

SERVO BOARD - CIRCUIT DIAGRAM

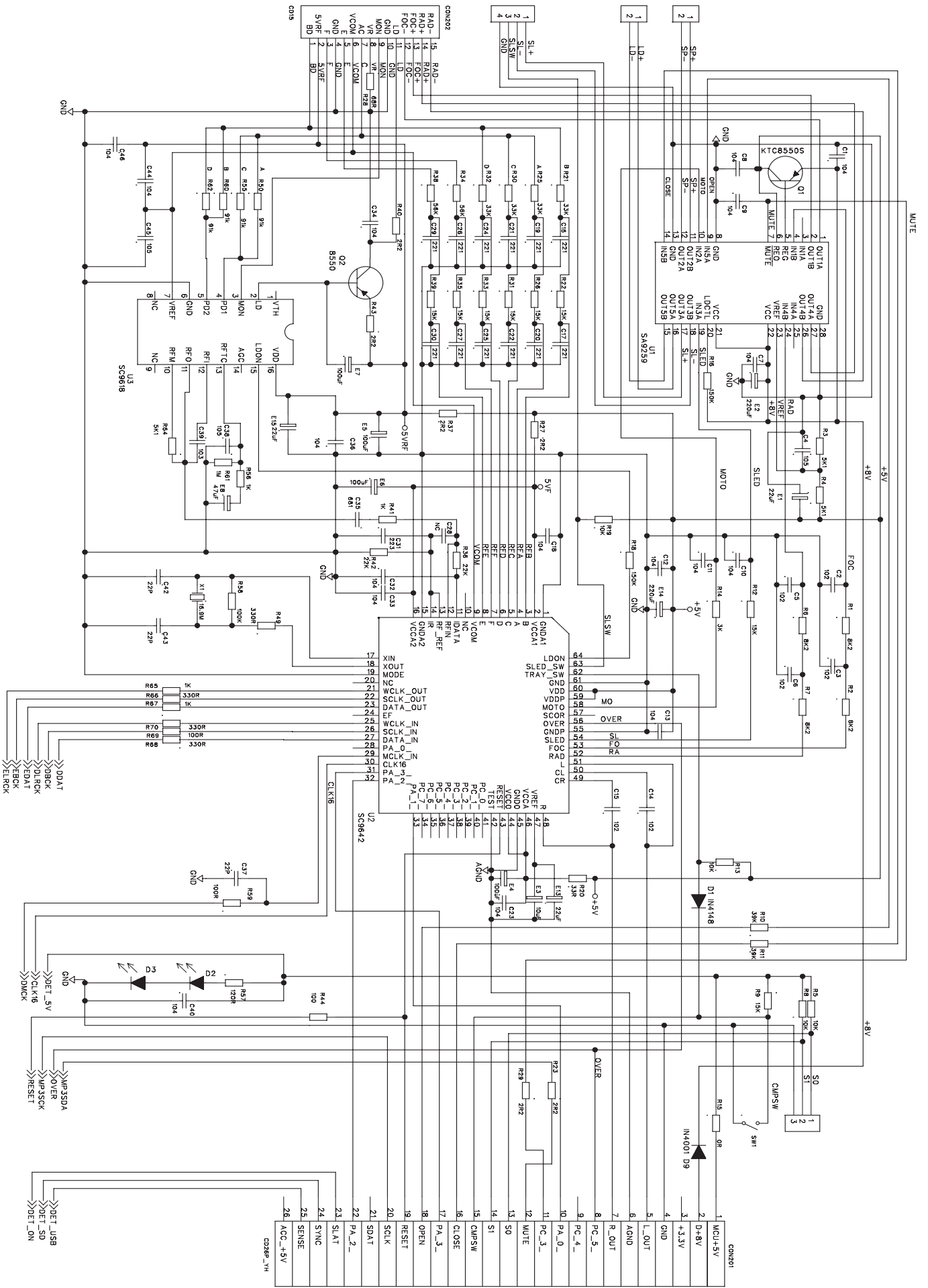

SERVO BOARD - CIRCUIT DIAGRAM

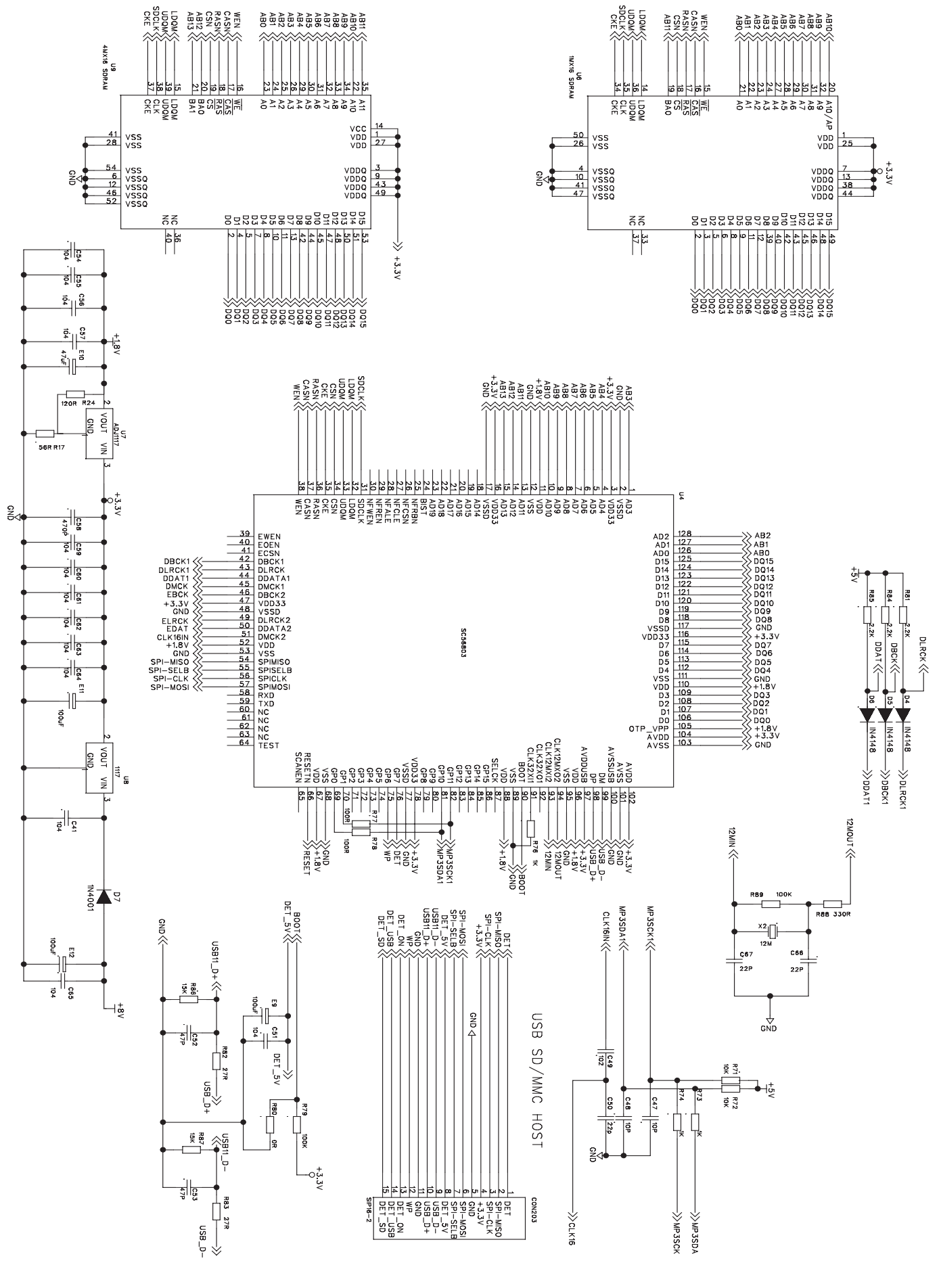

SERVO BOARD - LAYOUT DIAGRAM TOP VIEW

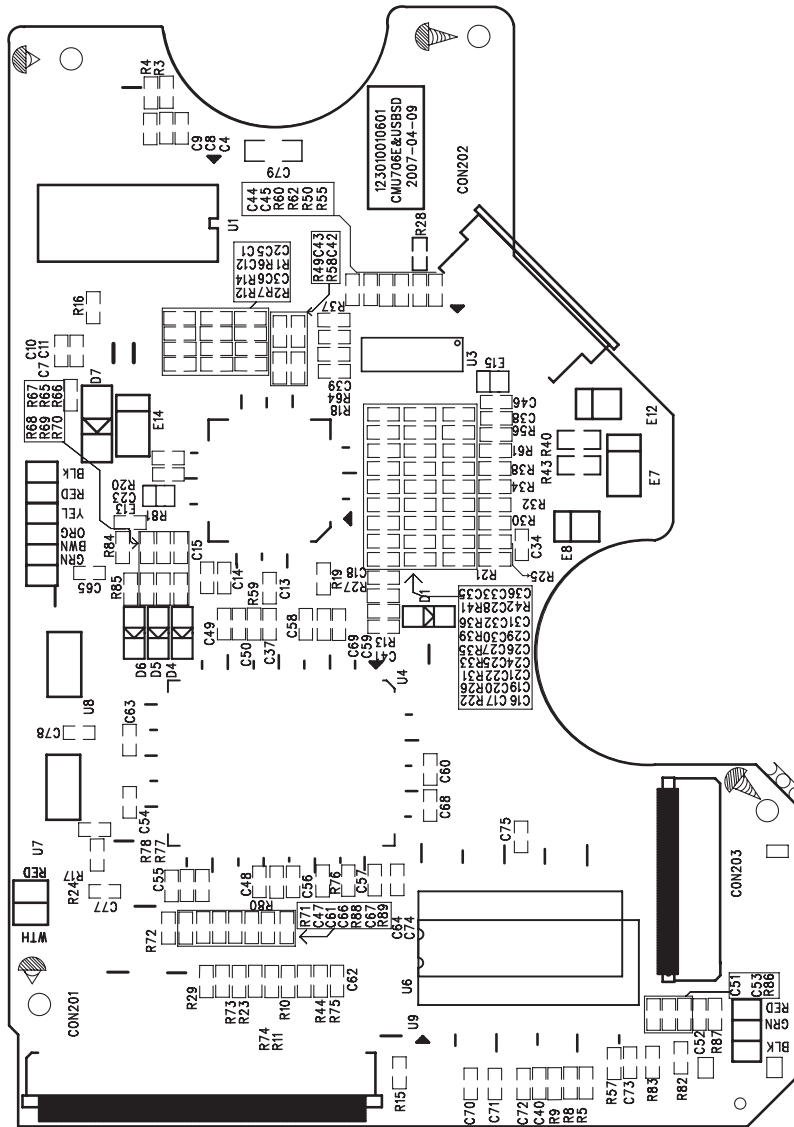

SERVO BOARD - LAYOUT DIAGRAM BOTTOM VIEW

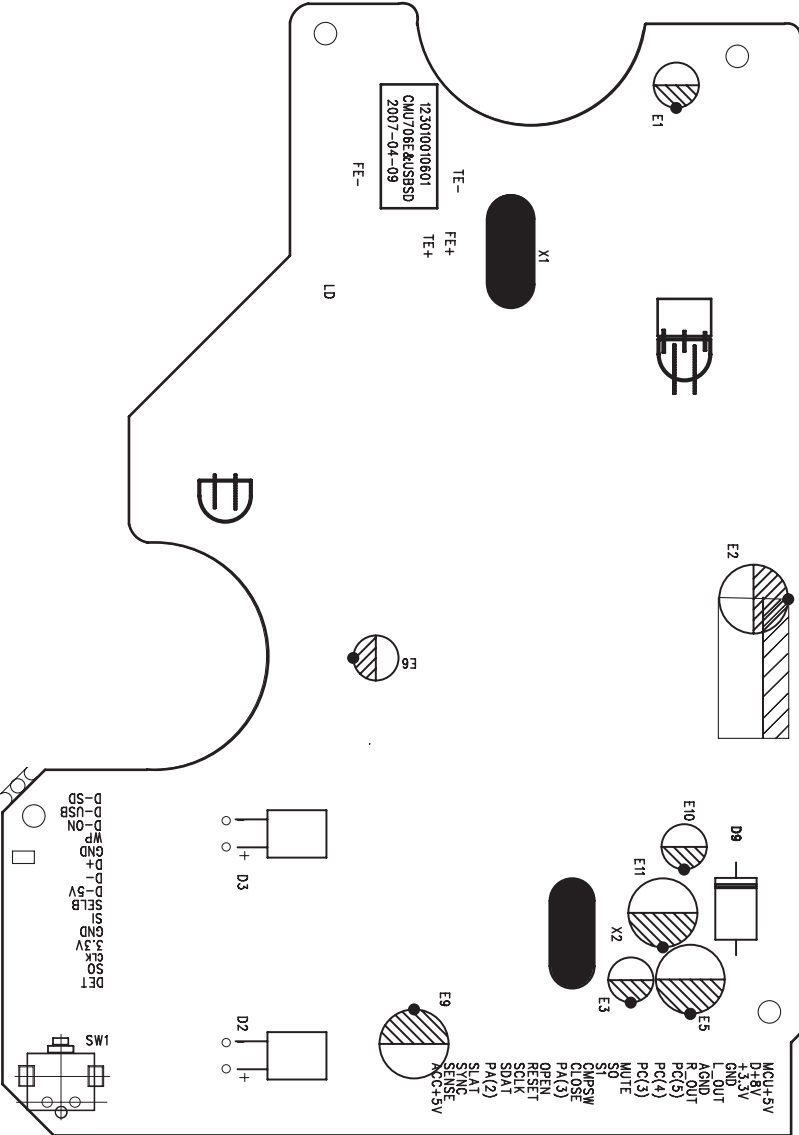

KB BOARD - CIRCUIT DIAGRAM

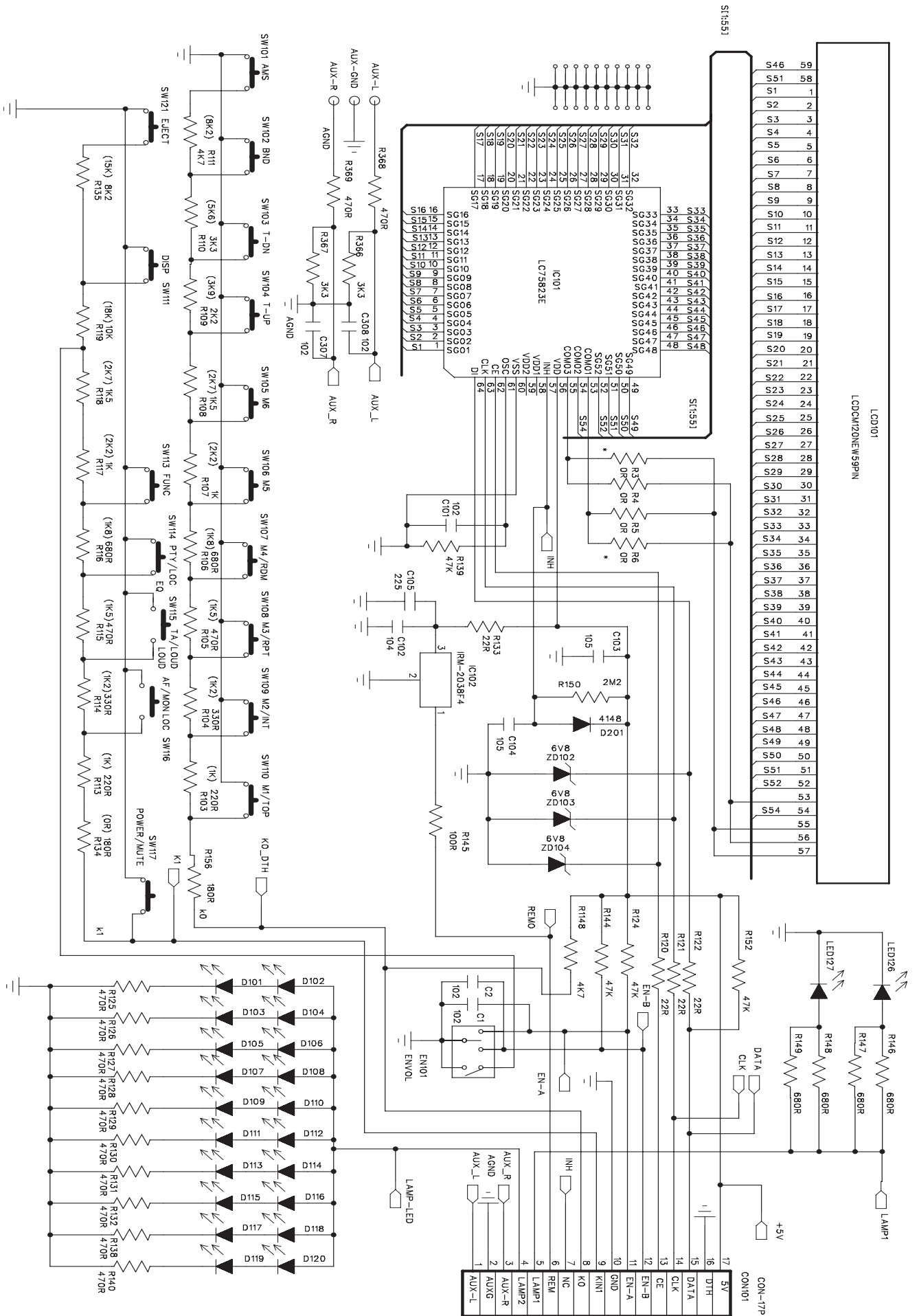

KB BOARD - CLAYOUT DIAGRAM TOP VIEW

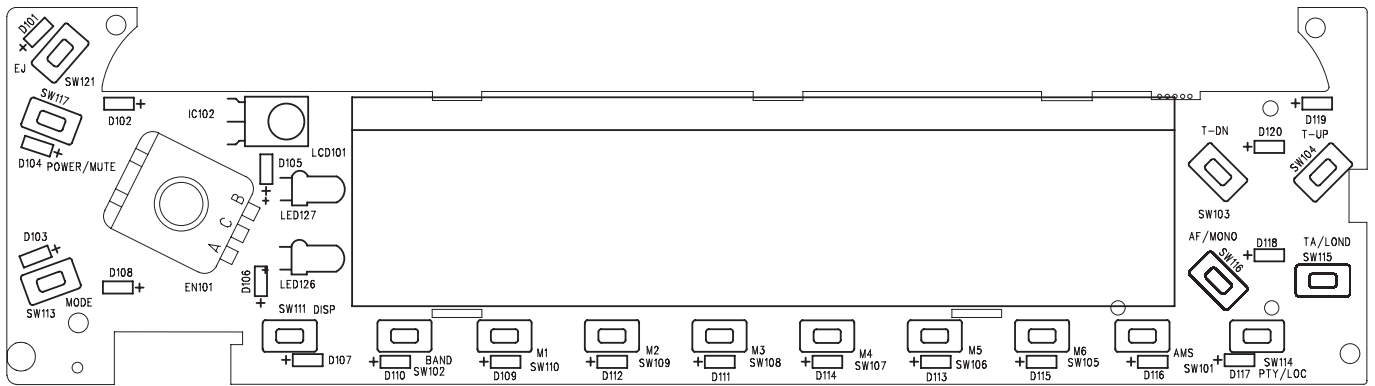

KB BOARD - CLAYOUT DIAGRAM BOTTOM VIEW

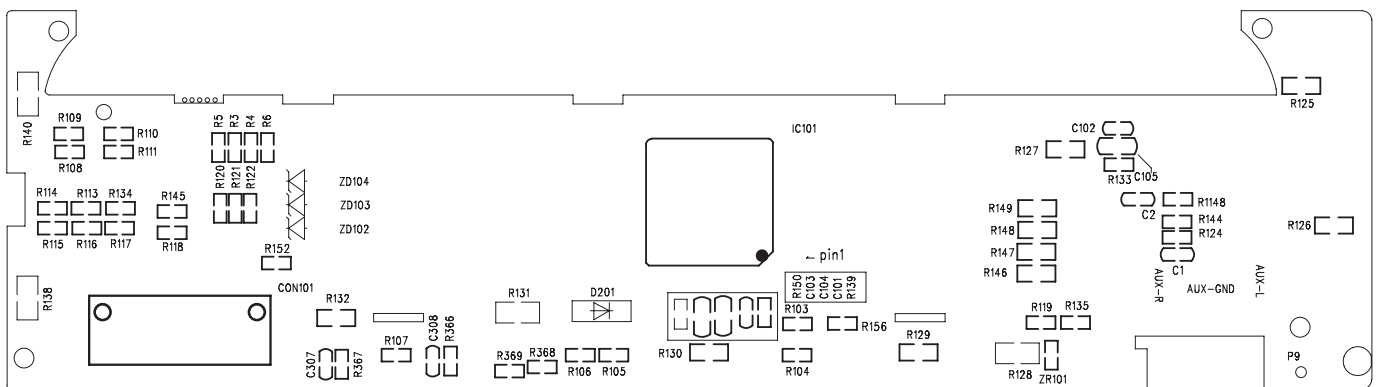

USB BOARD - CIRCUIT DIAGRAM

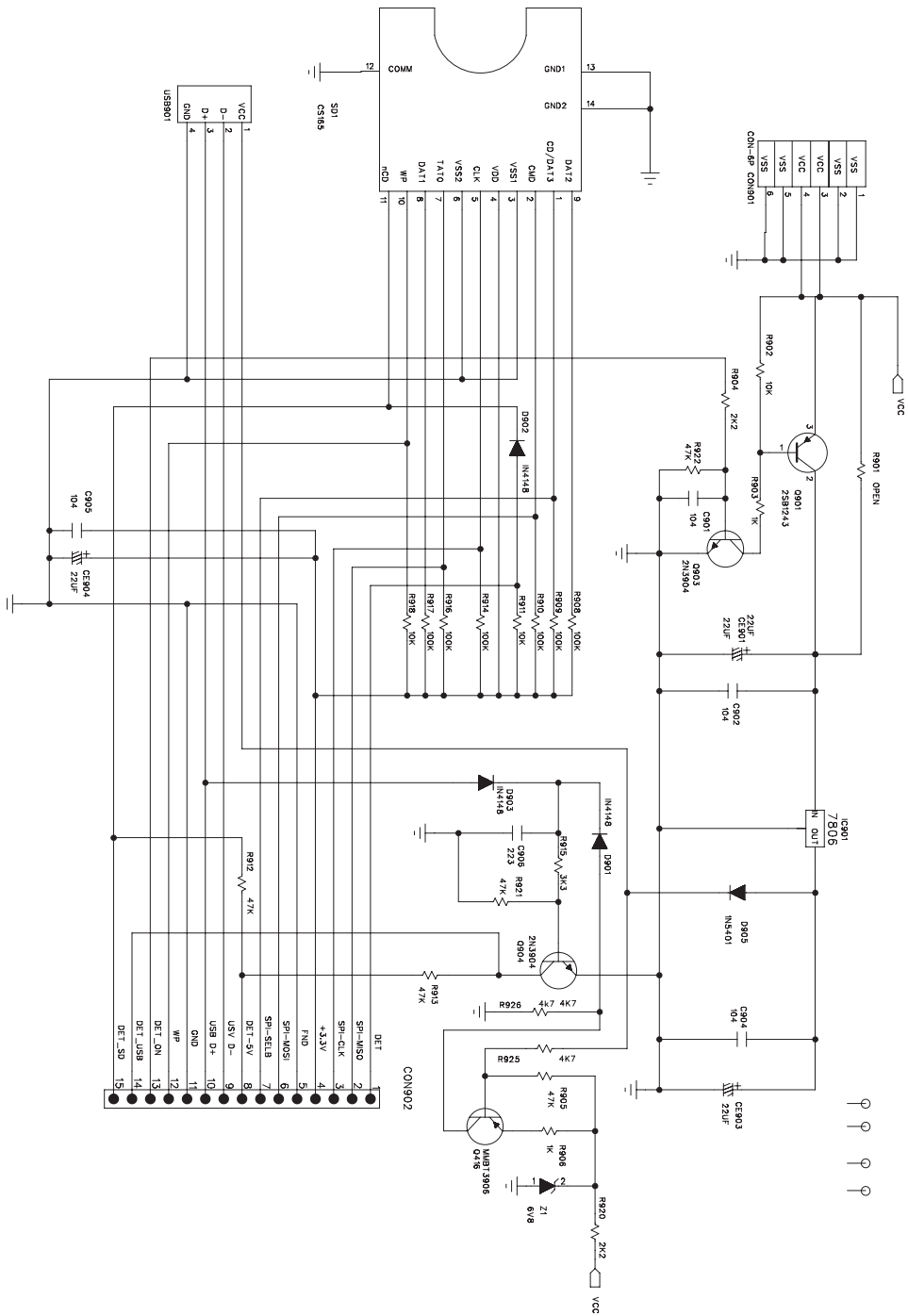

USB BOARD - CLAYOUT DIAGRAM TOP VIEW

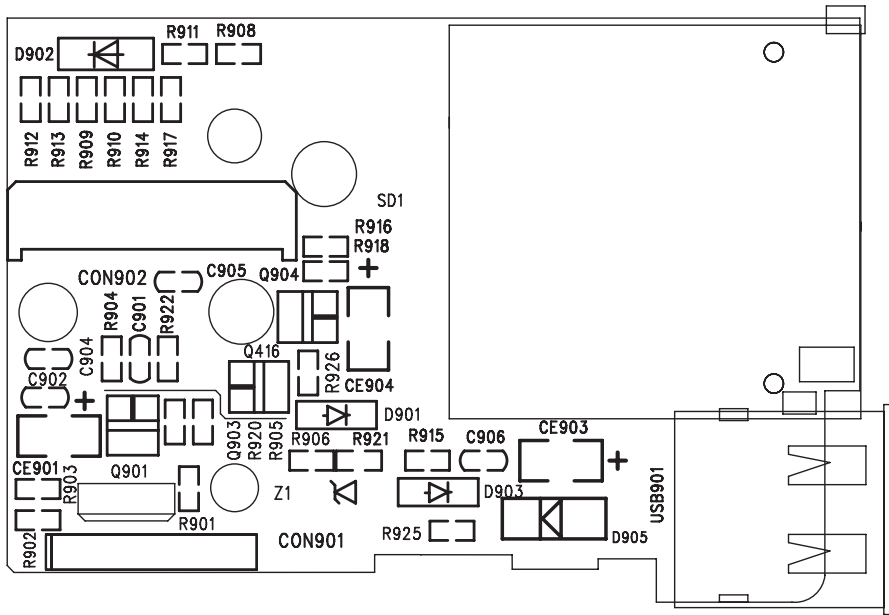

USB BOARD - CLAYOUT DIAGRAM BOTTOM VIEW

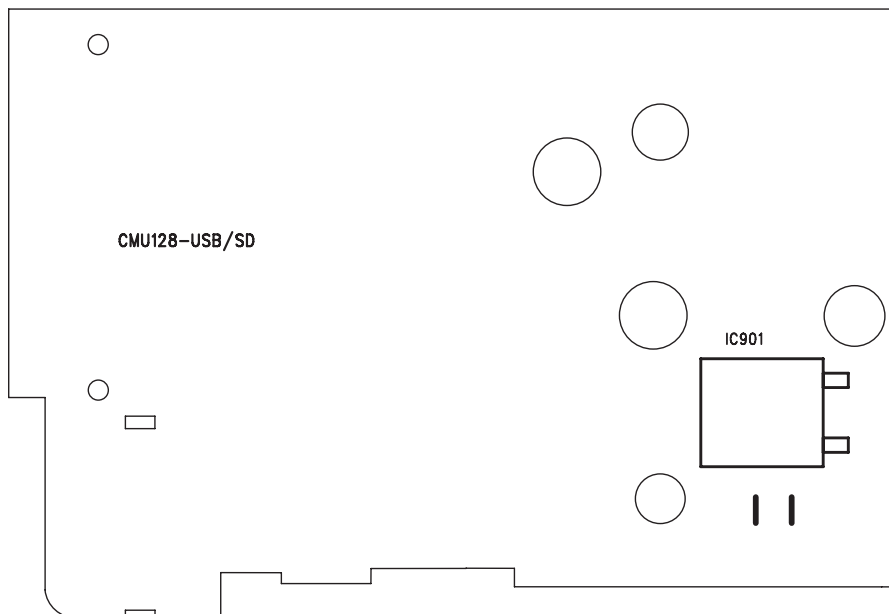

EXPLODED VIEW - MAIN NUIT

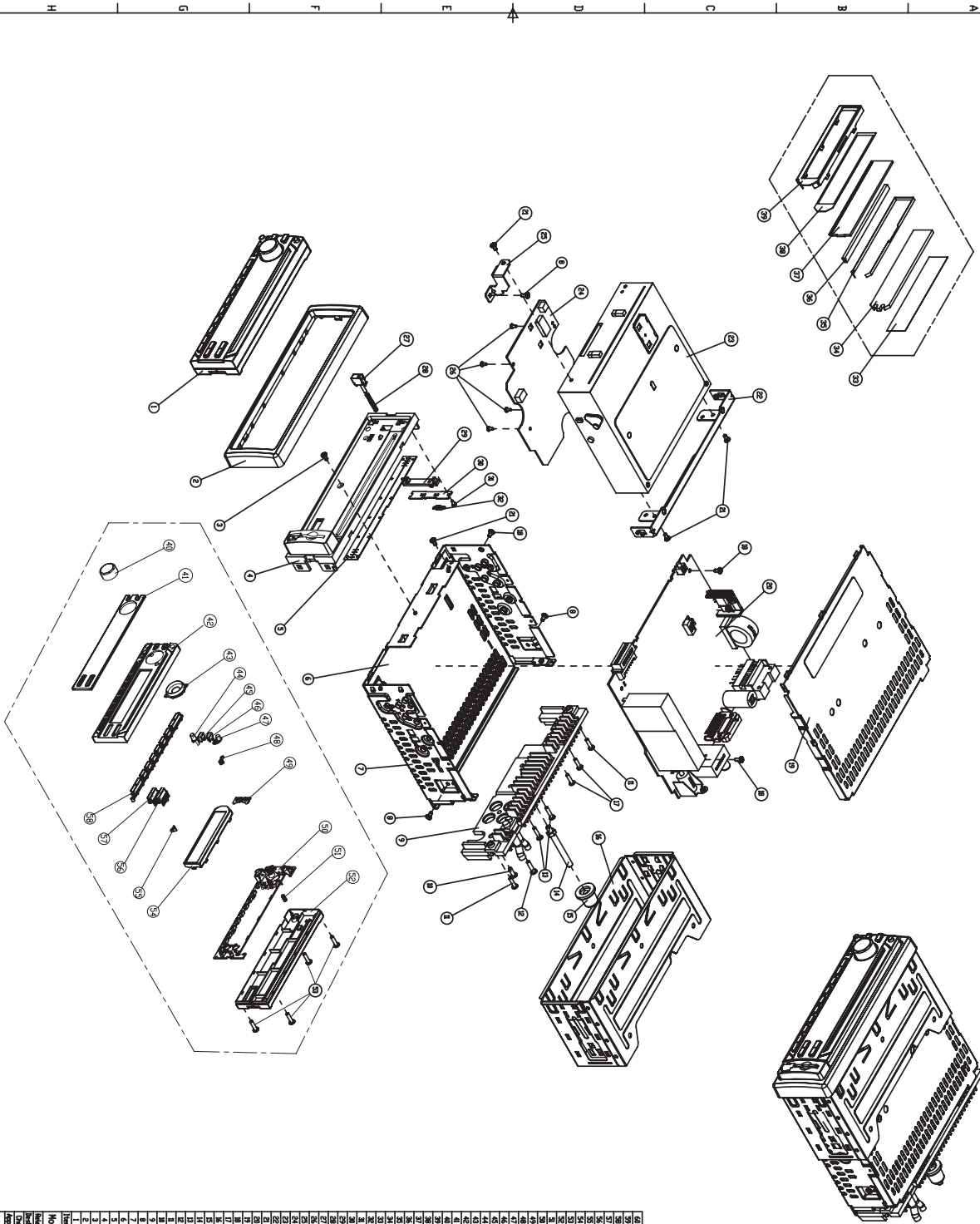

Part No.	Revision	Description	QTY	Unit	Material	Part No.	QTY	Unit	Material
49		FRONT PANEL	1						
50		BACK COVER	1						
51		PCB	1						
52		CONNECTOR	1						
53		CONNECTOR	1						
54		CONNECTOR	1						
55		CONNECTOR	1						
56		CONNECTOR	1						
57		CONNECTOR	1						
58		CONNECTOR	1						
59		CONNECTOR	1						
60		CONNECTOR	1						
61		CONNECTOR	1						
62		CONNECTOR	1						
63		CONNECTOR	1						
64		CONNECTOR	1						
65		CONNECTOR	1						
66		CONNECTOR	1						
67		CONNECTOR	1						
68		CONNECTOR	1						
69		CONNECTOR	1						
70		CONNECTOR	1						
71		CONNECTOR	1						
72		CONNECTOR	1						
73		CONNECTOR	1						
74		CONNECTOR	1						
75		CONNECTOR	1						
76		CONNECTOR	1						
77		CONNECTOR	1						
78		CONNECTOR	1						
79		CONNECTOR	1						
80		CONNECTOR	1						
81		CONNECTOR	1						
82		CONNECTOR	1						
83		CONNECTOR	1						
84		CONNECTOR	1						
85		CONNECTOR	1						
86		CONNECTOR	1						
87		CONNECTOR	1						
88		CONNECTOR	1						
89		CONNECTOR	1						
90		CONNECTOR	1						
91		CONNECTOR	1						
92		CONNECTOR	1						
93		CONNECTOR	1						
94		CONNECTOR	1						
95		CONNECTOR	1						
96		CONNECTOR	1						
97		CONNECTOR	1						
98		CONNECTOR	1						
99		CONNECTOR	1						
100		CONNECTOR	1						