

Title		
AUDIO_TEST		
Size	Number	Revision
A4	NO. 3	
Date:	27-Mar-2003	Sheet of
File:	E:\project\sc10\mainboard\version2\sc10_10_21_01.dwg	Drawn By:

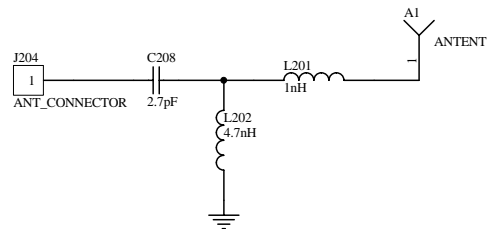

Title		
CONNECTOR_1		
Size	Number	Revision
A4	NO. 2	
Date:	27-Mar-2003	Sheet of
File:	E:\project\sc10\mainboard\version2\sc10_	Drawn By:

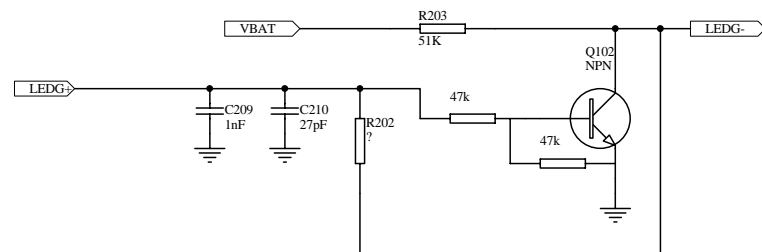
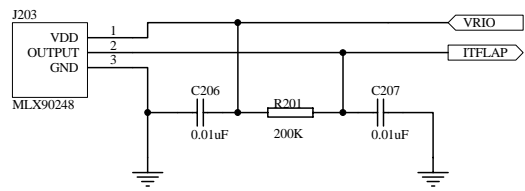
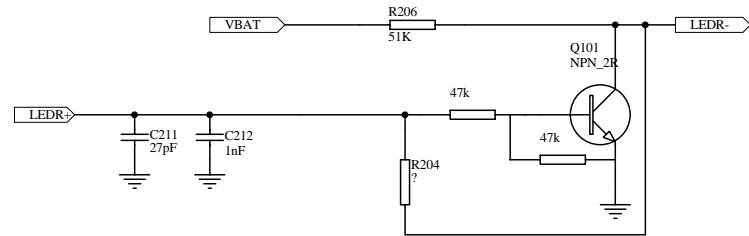
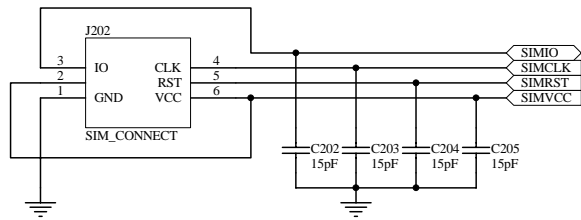
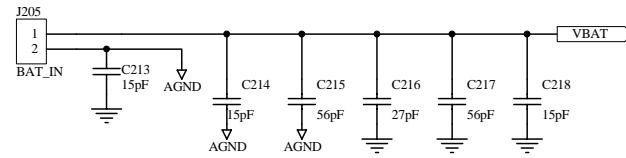
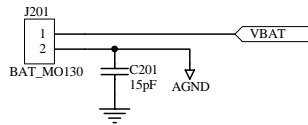
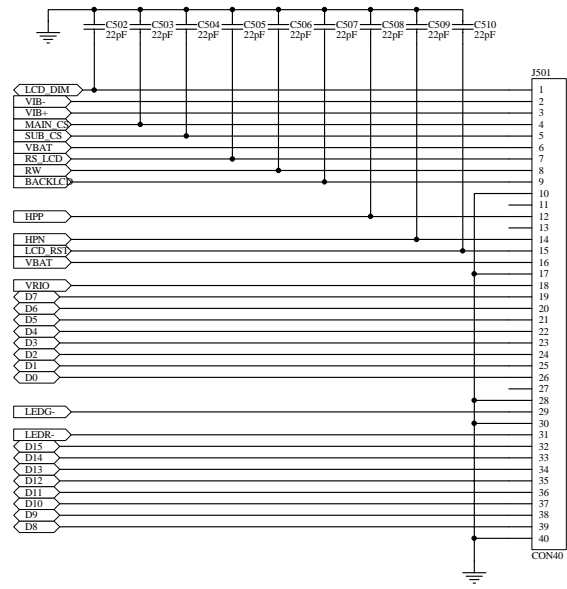
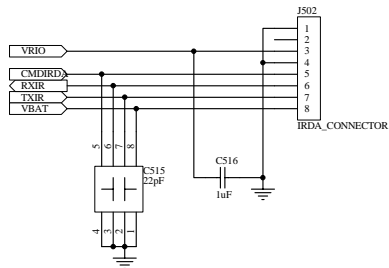
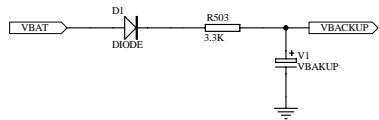

Title			CONNECTOR_2		
Size	Number	NO. 5		Revision	
B					
Date:	27-Mar-2003	Sheet of			
File:	E:\project\isc10\mainboard\version2\isc10		Printed By:		

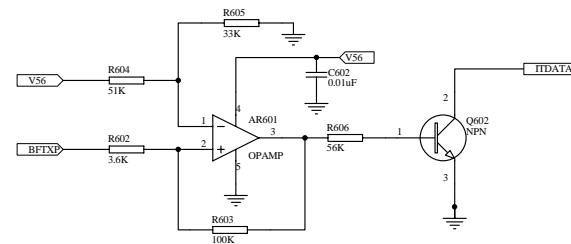
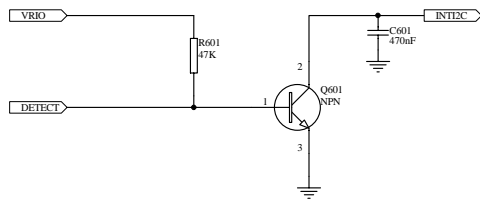

Title		
DETECT		
Size	Number	Revision
B	NO.6	
Date:	27-Mar-2003	Sheet of
File:	E:\project\sc10\mainboard\version2\sc10_11\lib\by:	

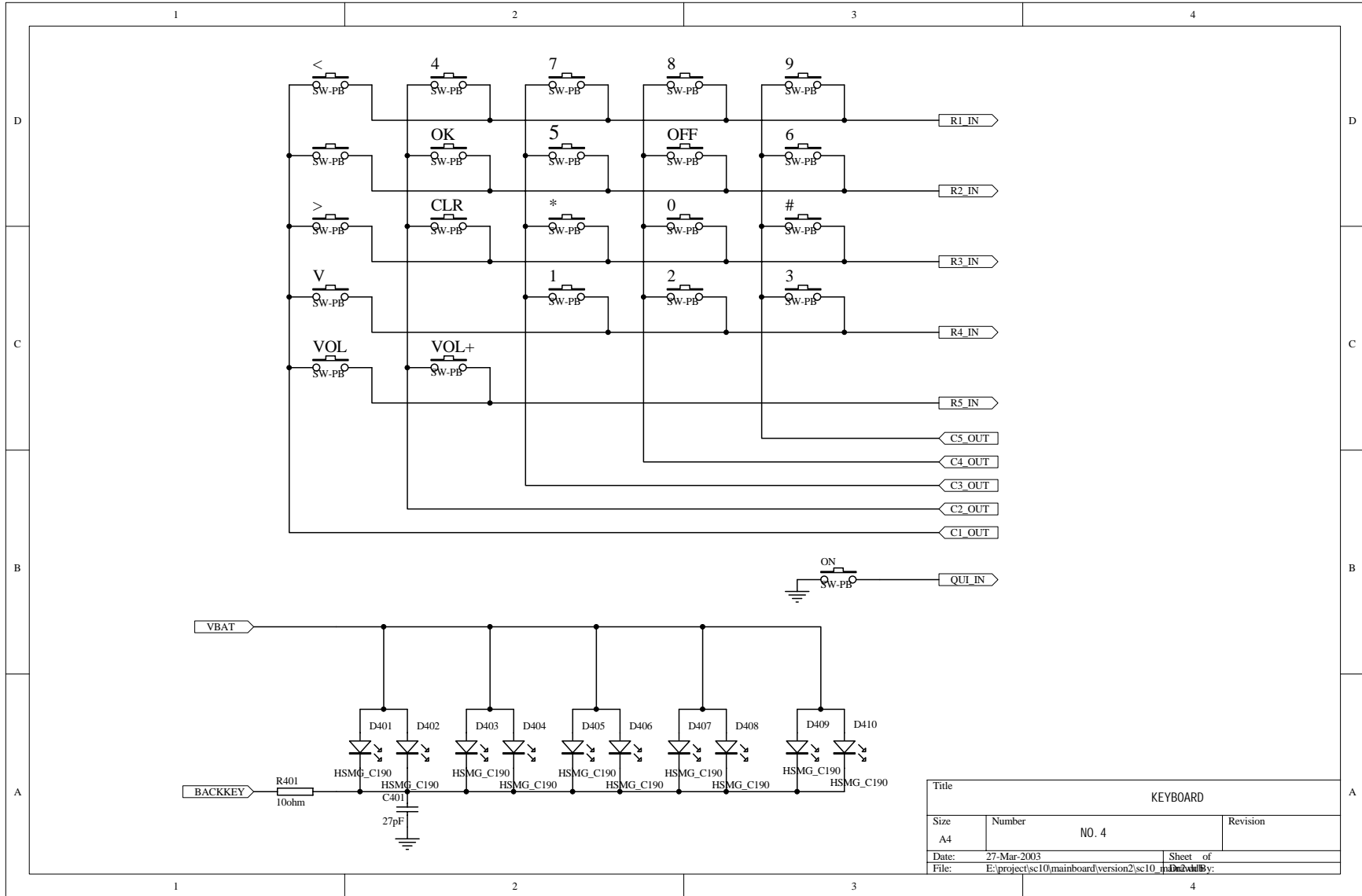

Title		
KEYBOARD		
Size	Number	Revision
A4	NO. 4	
Date:	27-Mar-2003	Sheet of
File:	E:\project\sc10\mainboard\version2\sc10_keyboard.dwg	Drawn By:

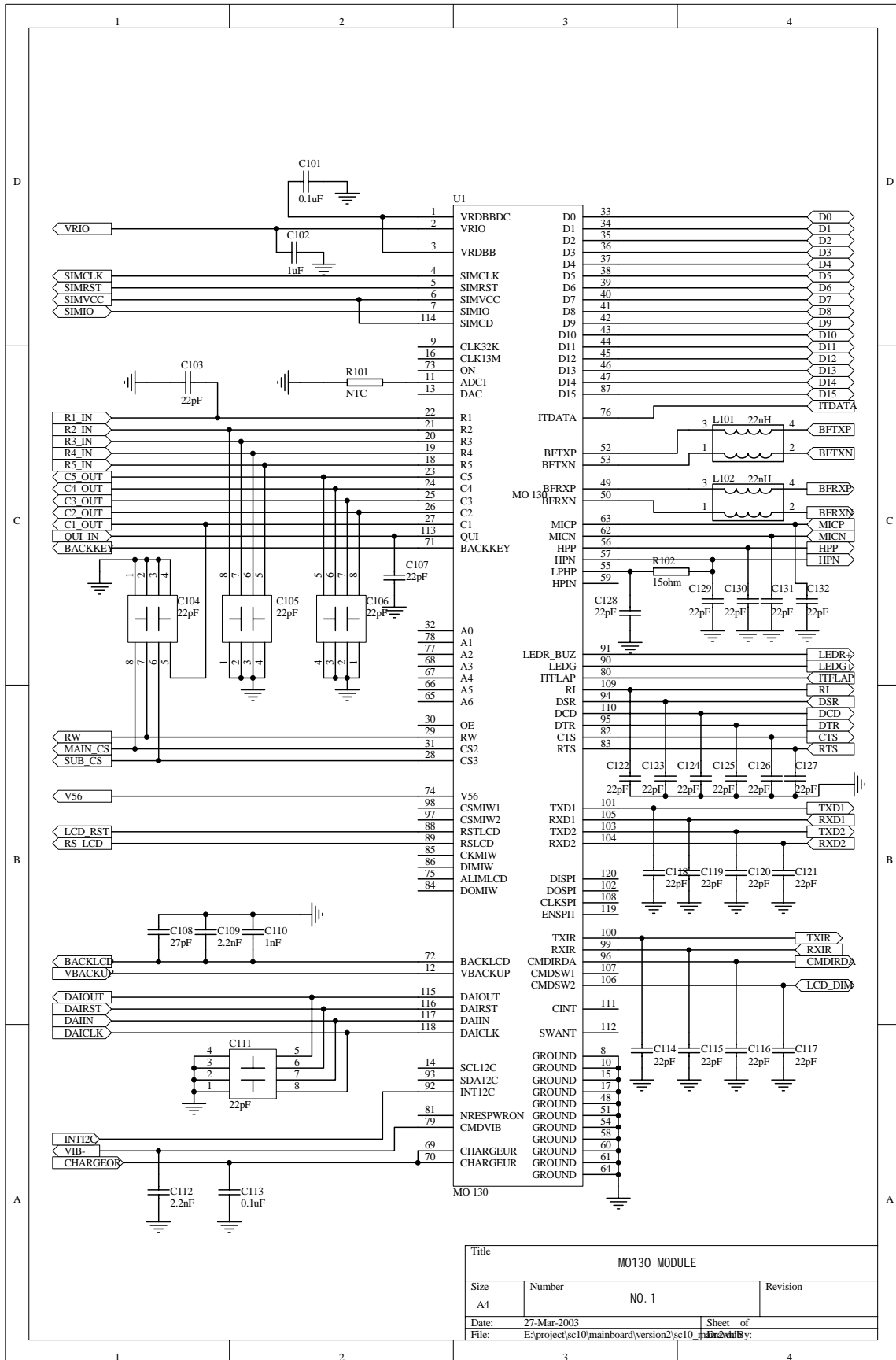

Title			MO130 MODULE		
Size	Number	Revision			
A4	NO. 1				
Date:	27-Mar-2003	Sheet of			
File:	E:\project\sc10\mainboard\version2\sc10	Drawn By:			

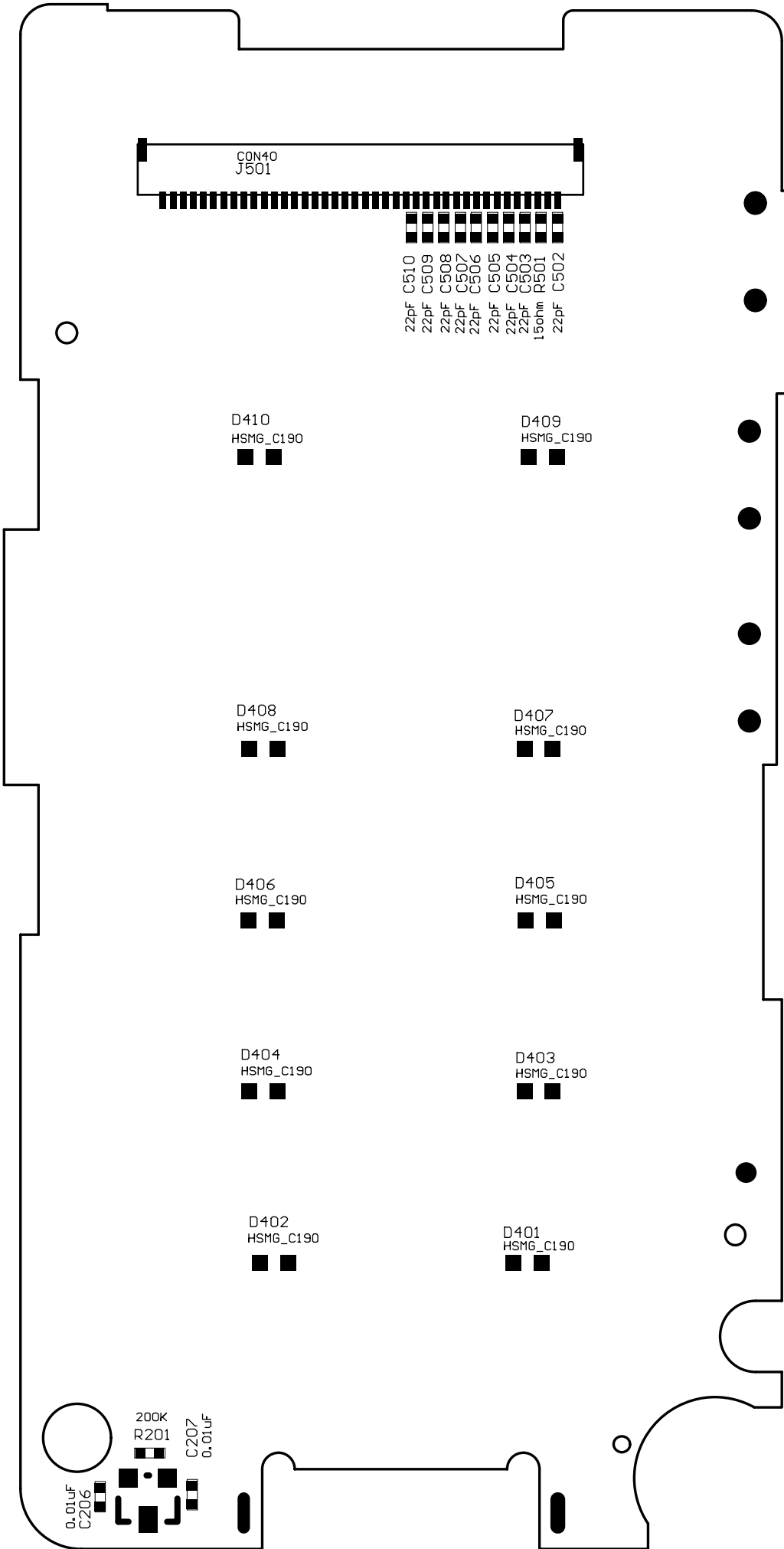

MLX90248
J203

