

Title		
MO130m MODULE_V3		
Size	Number	Revision
A4	NO. 1	
Date:	5-Nov-2003	Sheet of
File:	E:\project\sc14\mainboard\version3\sc14	Drawn By:

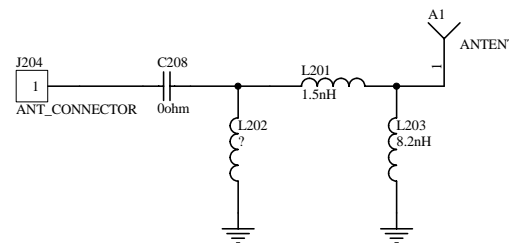

Title			CONNECTOR_1_v3		
Size	Number	Revision			
A4	NO. 2				
Date:	5-Nov-2003	Sheet of			
File:	E:\project\sc14\mainboard\version3\sc14	Drawn By:			

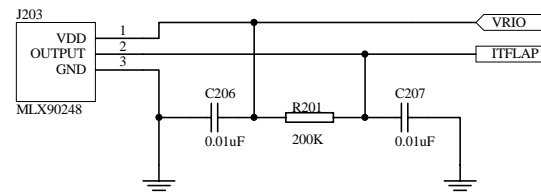
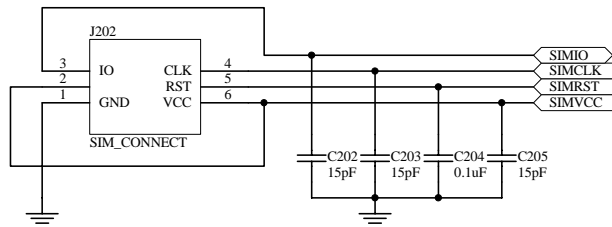
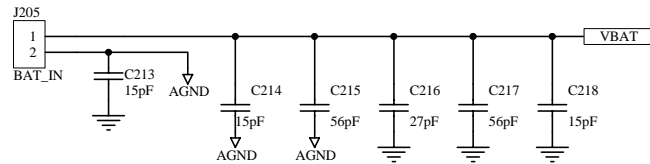
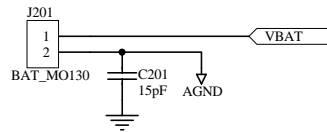
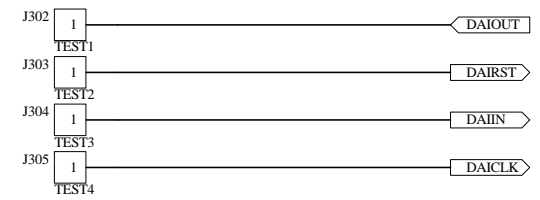
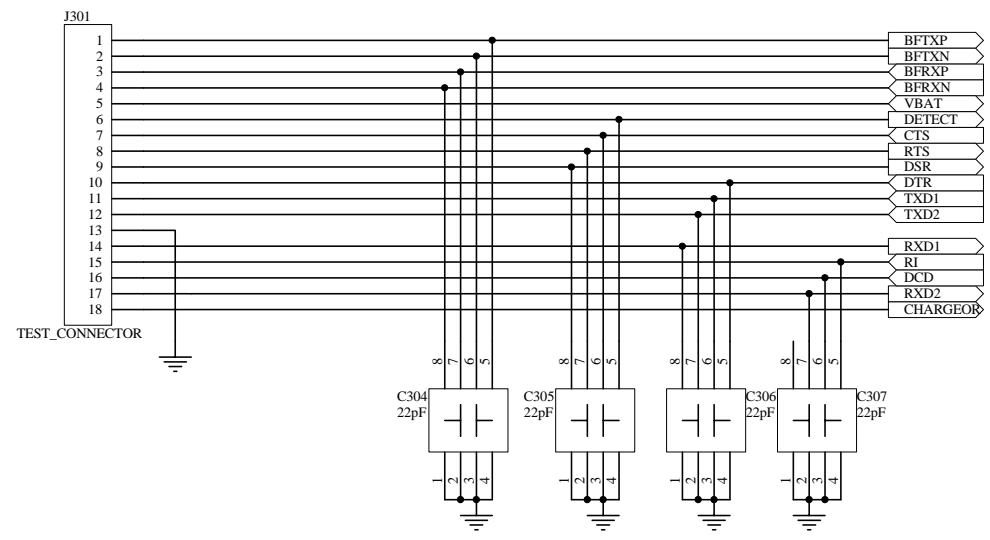
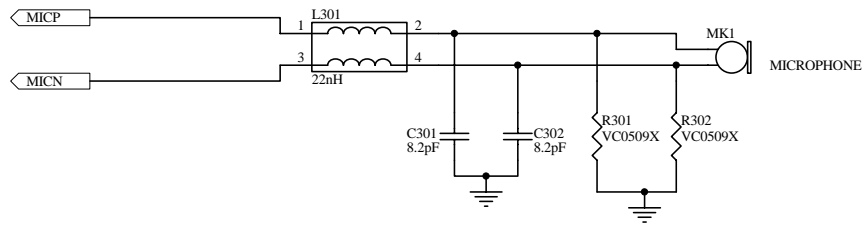

Title			AUDI0_TEST_v3		
Size	Number	Revision			
A4	NO. 3				
Date:	5-Nov-2003	Sheet of			
File:	E:\project\sc14\mainboard\version3\sc14	Drawn By:			

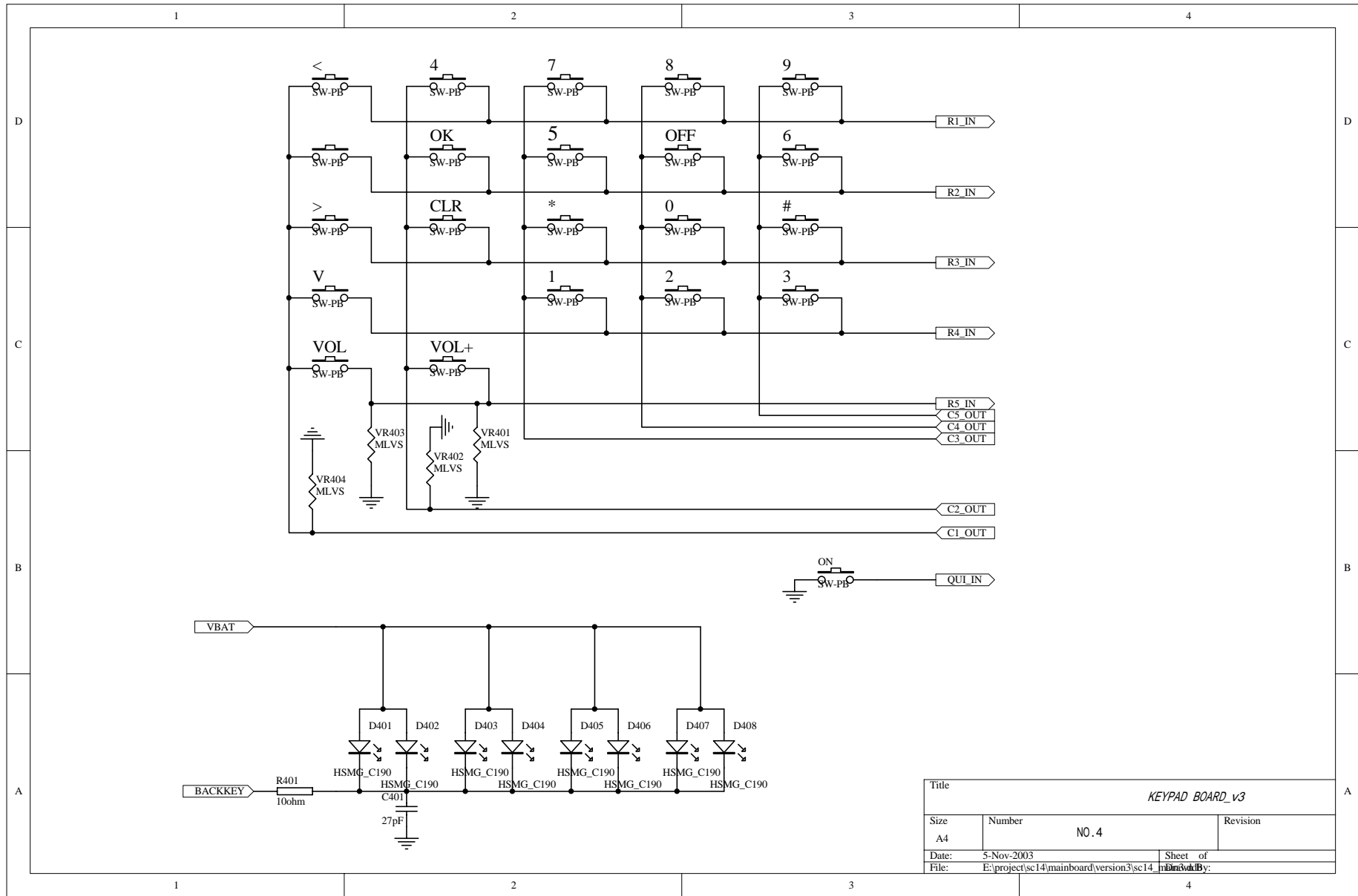

Title			KEYPAD BOARD v3		
Size	Number	Revision			
A4	NO. 4				
Date:	5-Nov-2003	Sheet of			
File:	E:\project\sc14\mainboard\version3\sc14	Drawn By:			

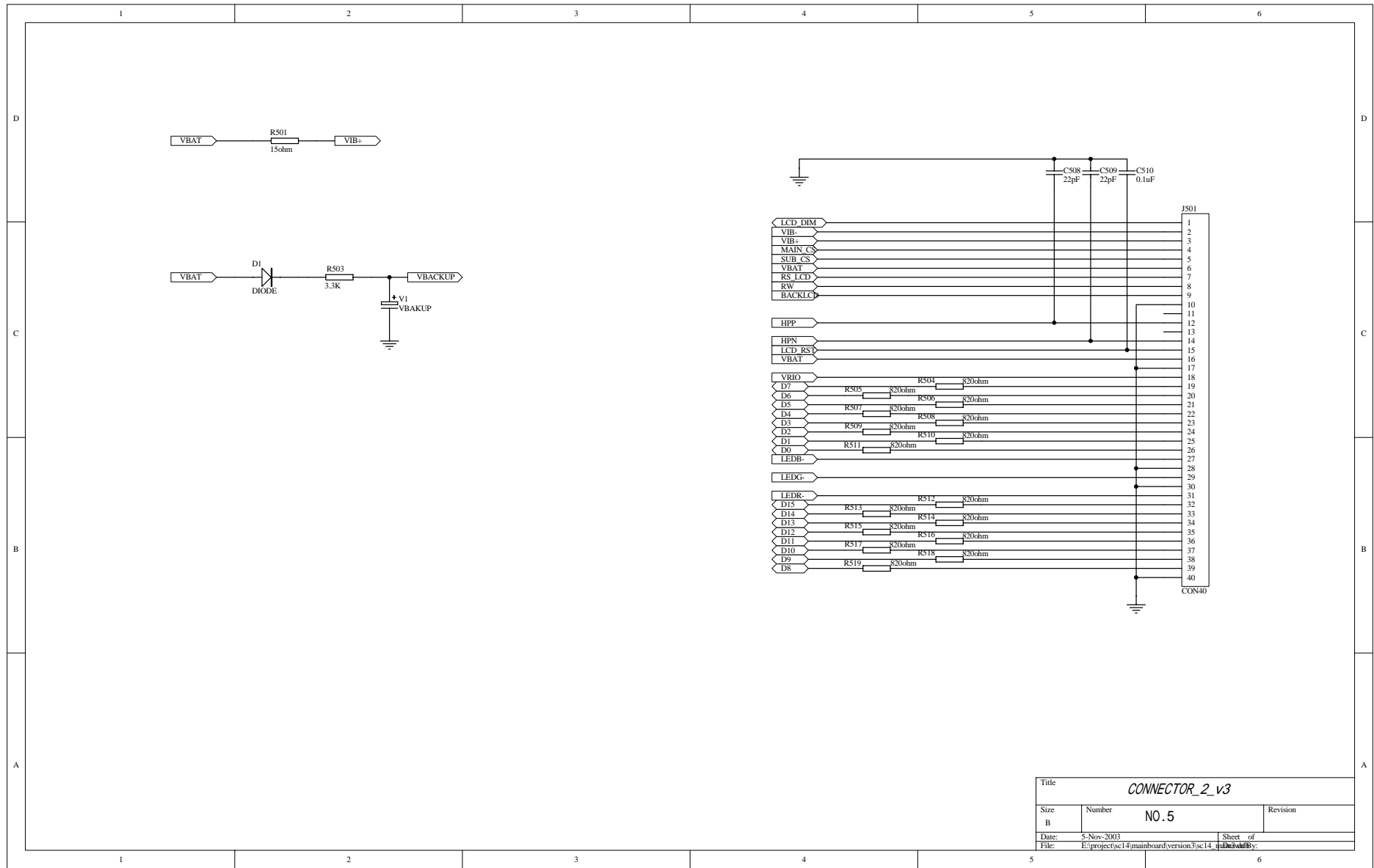

Title			CONNECTOR_2_v3		
Size	Number	NO. 5		Revision	
B					
Date:	5-Nov-2003	Sheet of			
File:	E:\project\sc14\mainboard\version.5\sc14_	pub\sc14\B5:			

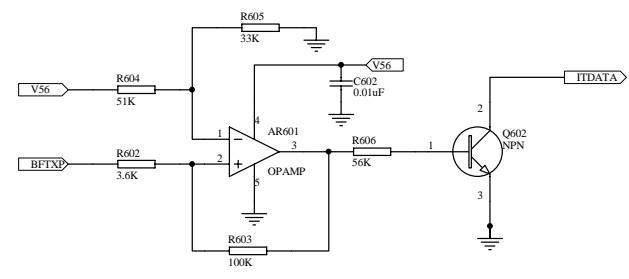
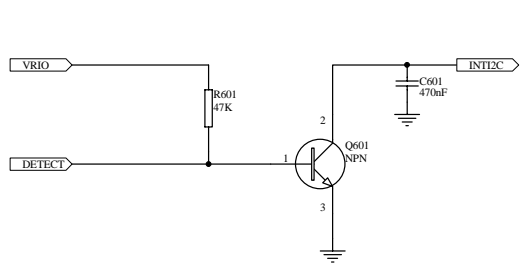

Title			DETECT_v3		
Size	Number	NO.6		Revision	
B					
Date:	5-Nov-2003	Sheet of			
File:	E:\project\sc14\mainboard\version.5\sc14_	pub\det		By:	

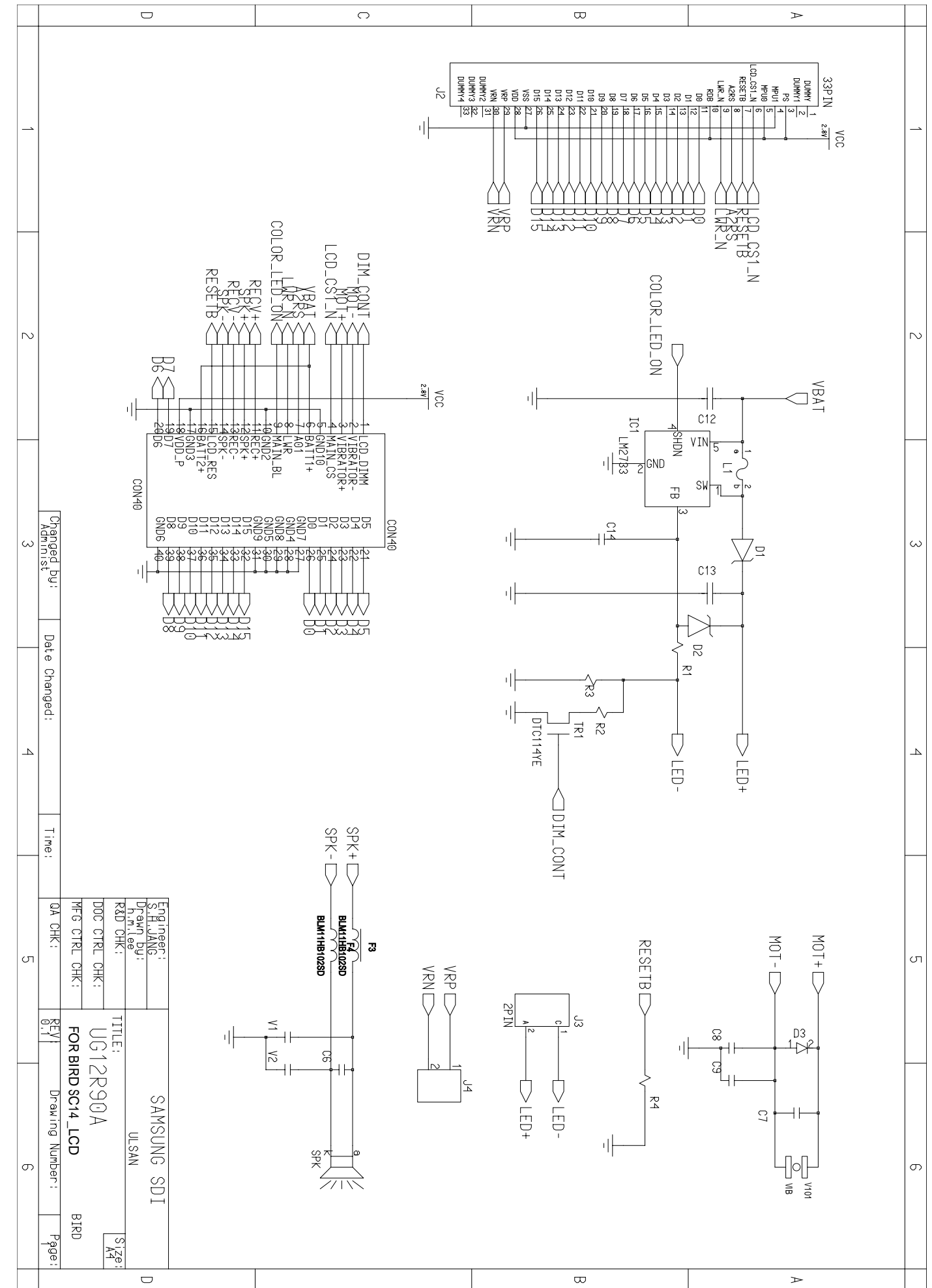

Changed by: Administ  
Date Changed:

Engineer:	S. H. JANG	SAMSUNG SDI
Drawn by:	Ulsan	ULSAN
Checked:		
R&D CHK:		
DOC CTRL CHK:	UG12R90A	SIZE: A1
MFG CTRL CHK:	FOR BIRD SC14_LCD	BIRD
QA CHK:		
KEY:		Drawing Number:
		Page: