

CHARGER

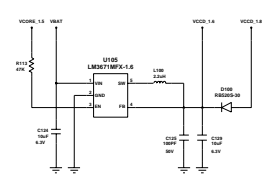

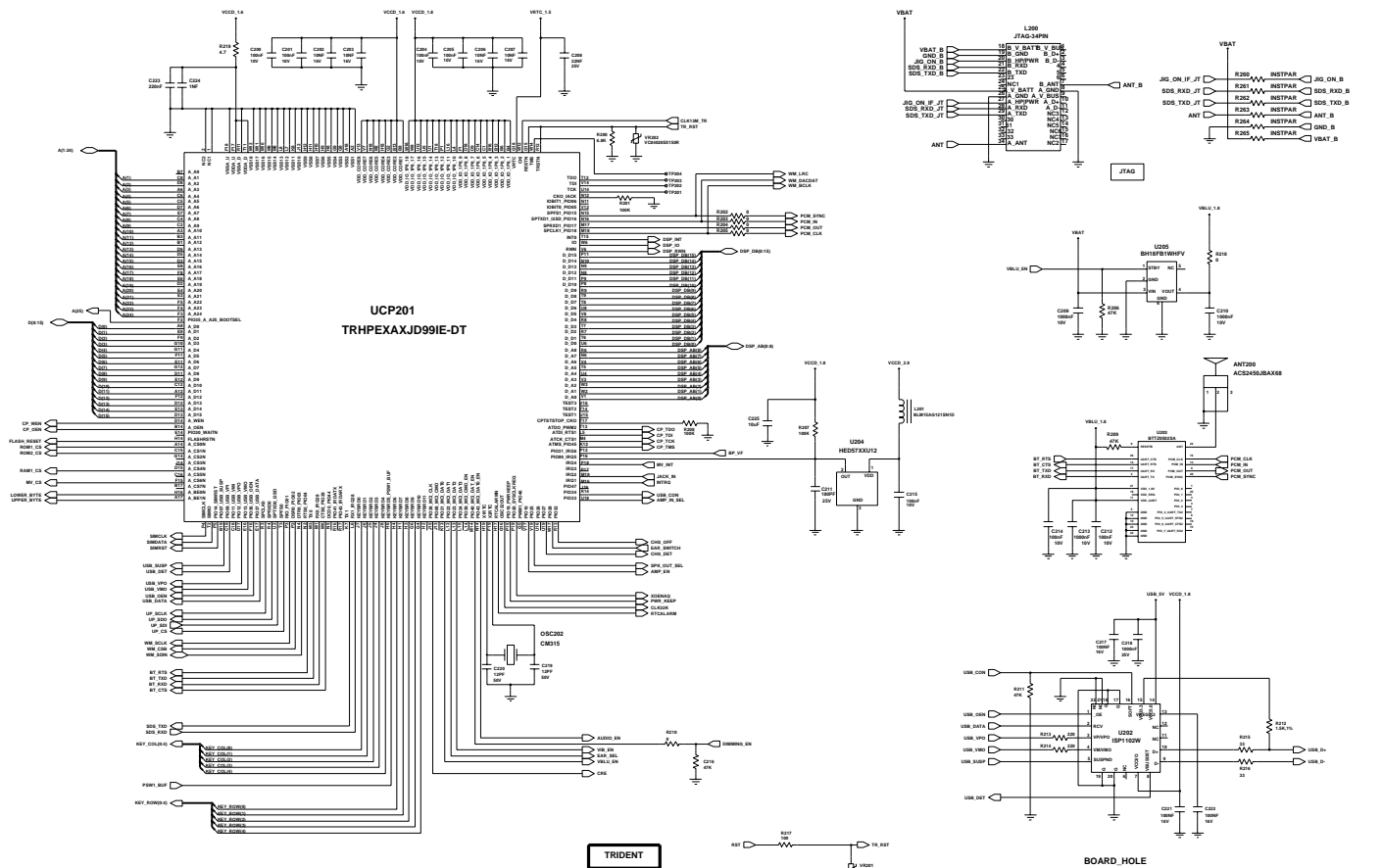

TRIDENT

BOARD HOLE



Part No.	SGH-X680	Rev.	REV.1.1
Product Name	SGH-X680		
Manufacturer	SAMSUNG ELECTRONICS		
Design Date		Drawn By	
Checked By		Design No.	
Approved By		Sheet	1 of 1

1 2 3 4 5 6 7 8 9 10 11 12

A
B
C
D
E
F
G
H

MEMORY

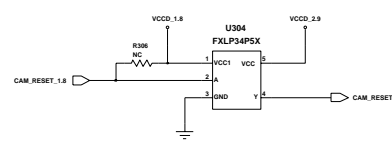
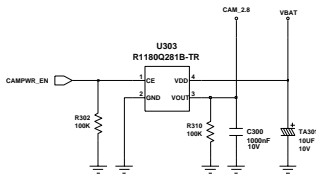
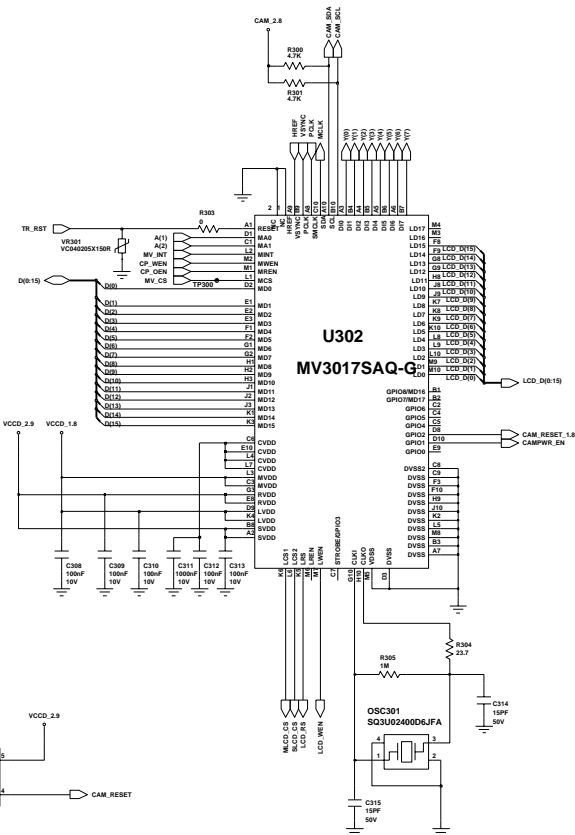
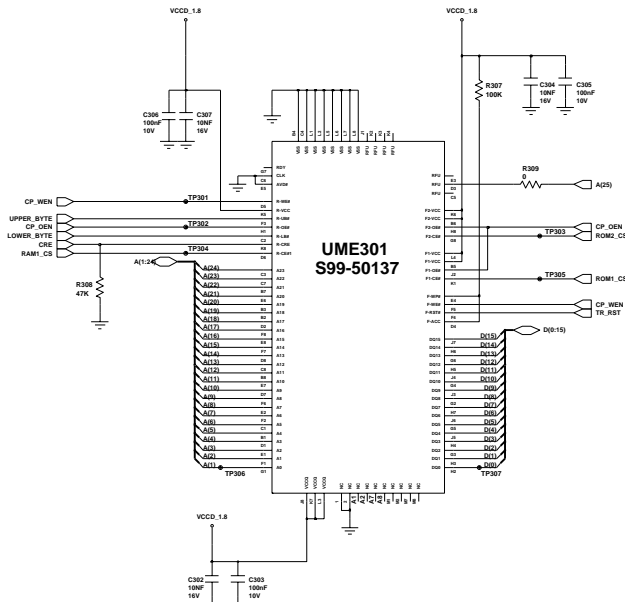

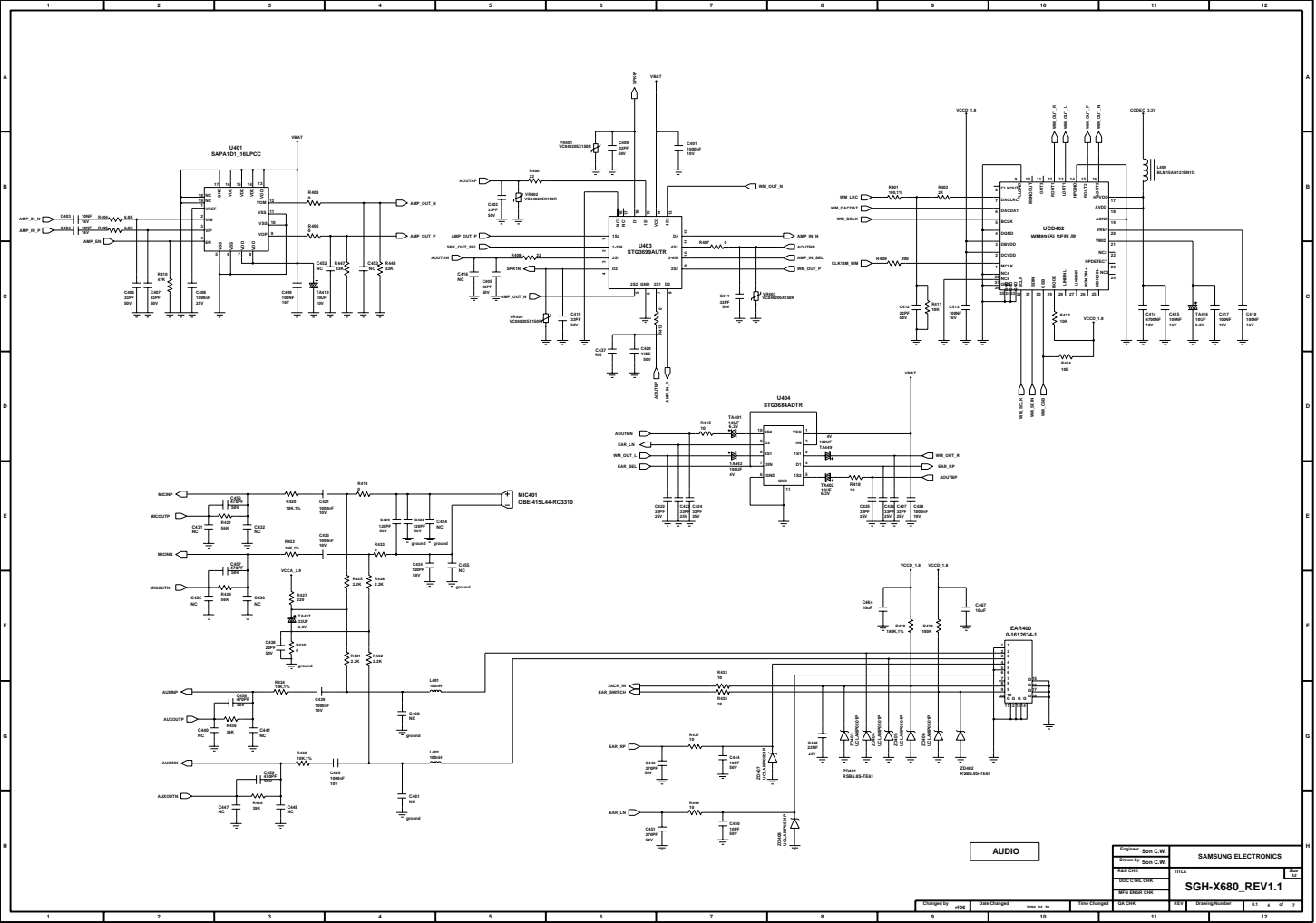

AUDIO

Engineer: Alan C.W.	DATE: 2008.04.10	SAMSUNG ELECTRONICS
Checked by: Alan C.W.	DATE: 2008.04.10	
Approved by: Alan C.W.	DATE: 2008.04.10	SGH-X680_REV1.1
Checked by: Alan C.W.	DATE: 2008.04.10	
Approved by: Alan C.W.	DATE: 2008.04.10	Sheet 1 of 1

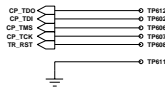

JTAG CON

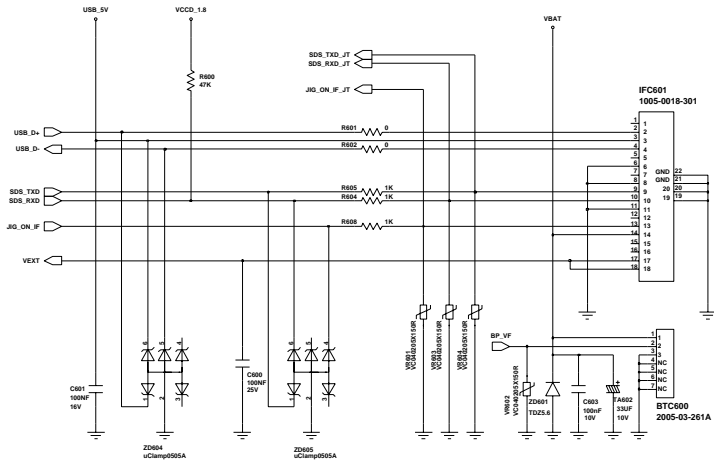

I/F CONNECTOR

Engineer	Sen C.W.	SAMSUNG ELECTRONICS SGH-X680_REV1.1	Size
Drawn by	Sen C.W.		AS
R&D CHK			TITLE:
DOC CTRL CHK			
MFG ENGR CHK			

