

	FE8H1	FE8H2
Ta0C08000	L	L
Ta0C08000a	L	R1
Ra0C08000	L	L
Ra0C08000a	L	L
Ra0PC08000	L	L

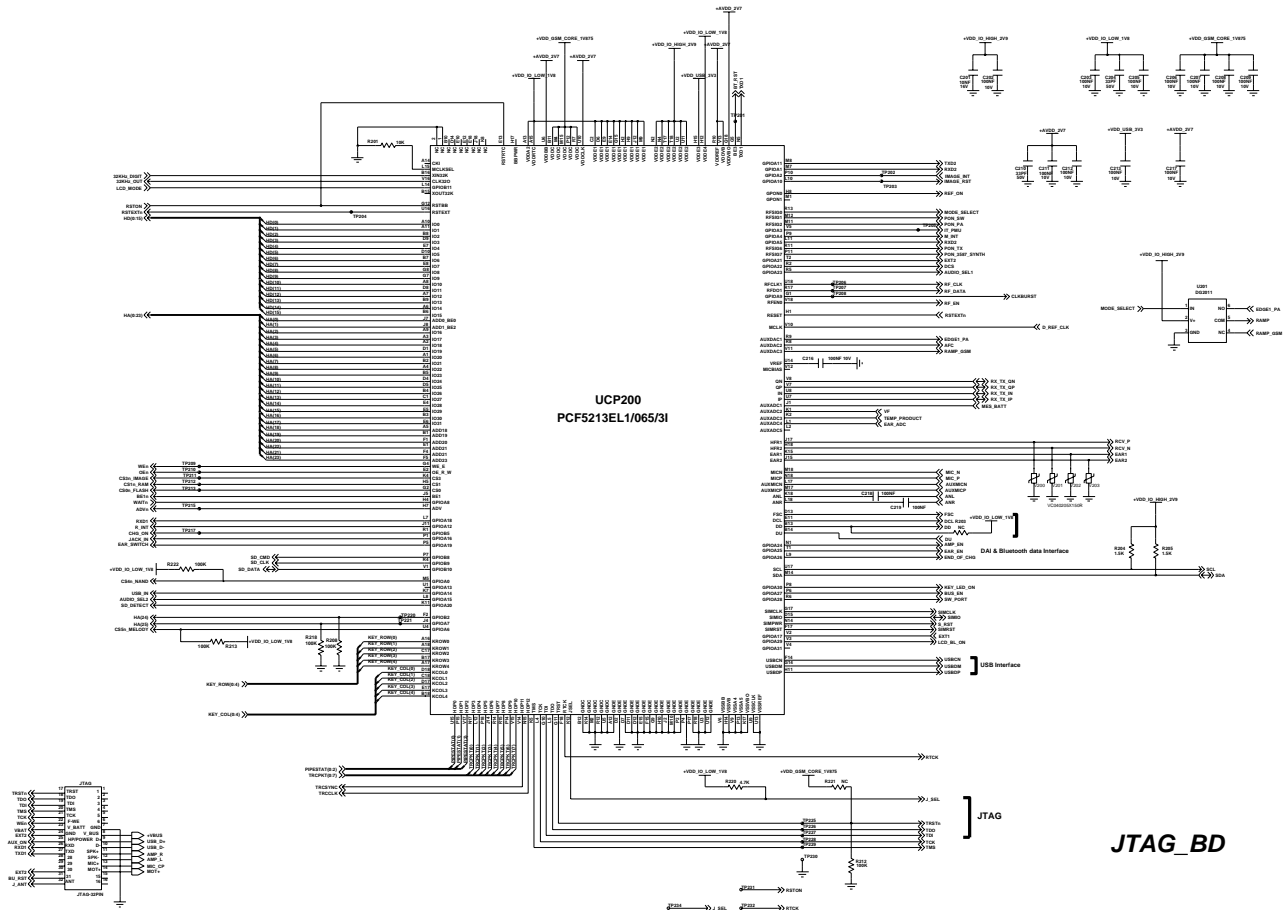

J-TAG 32 PINS

JTAG_BD

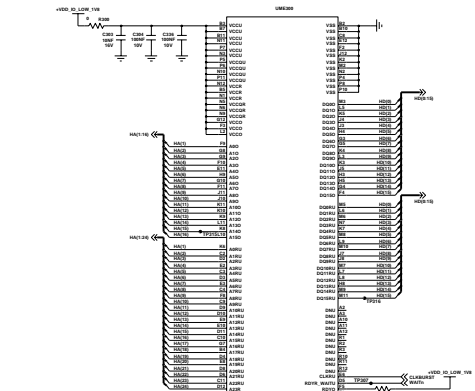

D_Class_AMP

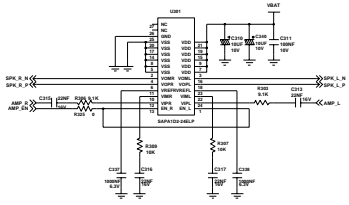

FM RADIO

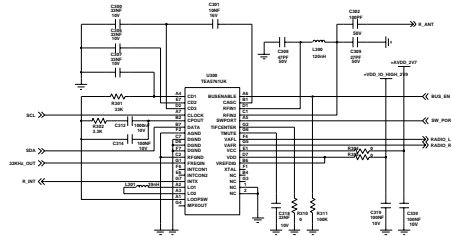

MEMORY

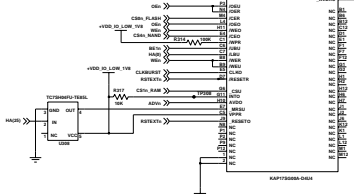

BLUE TOOTH

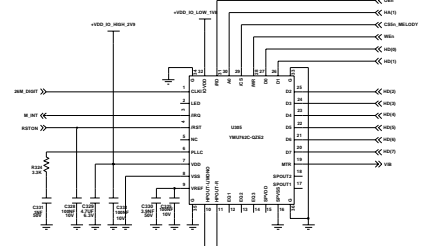

MELODY IC

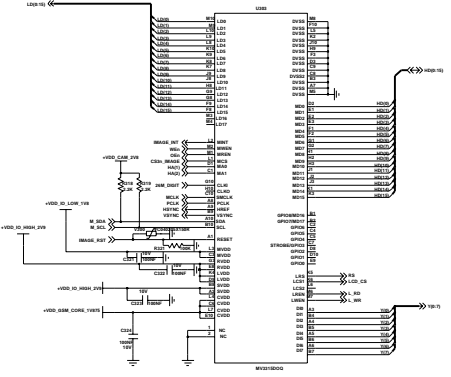

IMAGE_DSP

DC/DC Down Converter(1.8Volt)

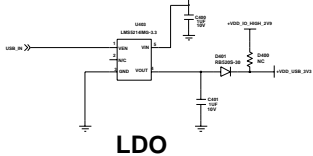

LDO

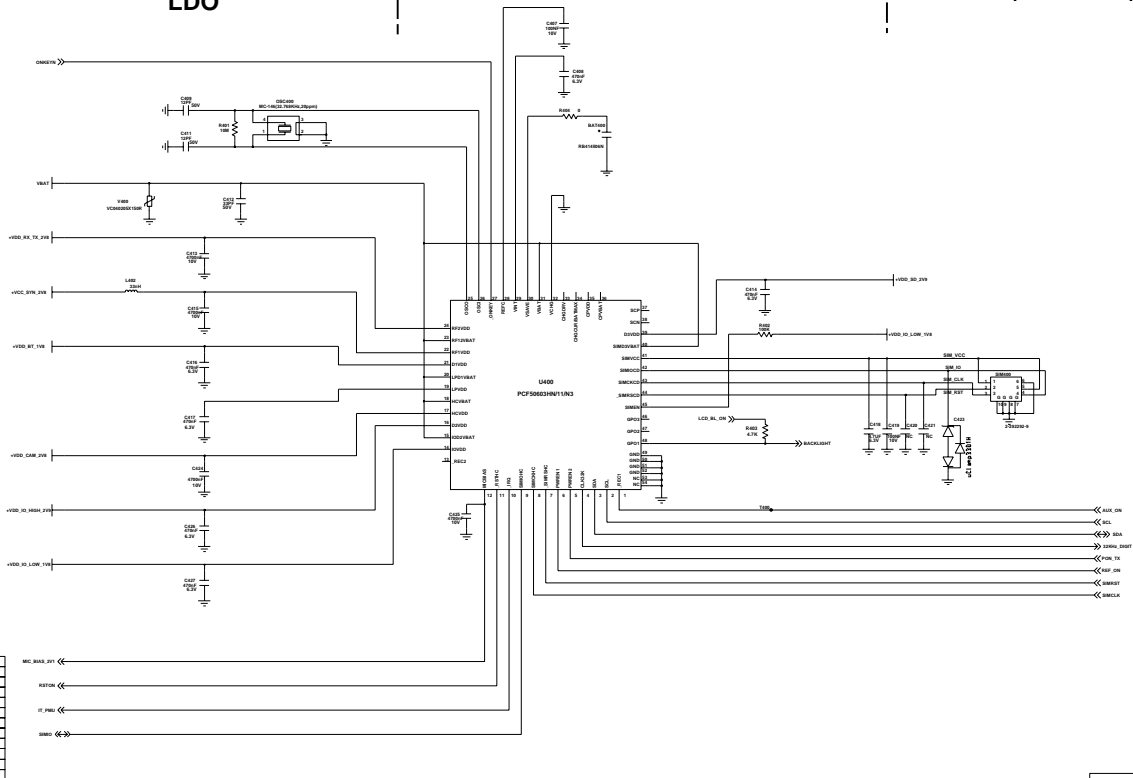
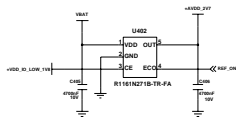
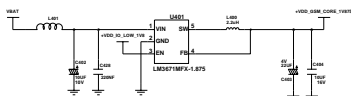

VDD_0V	0.00V
VDD_1V8	1.80V
VDD_1V2	1.20V
VDD_0V9	0.90V
VDD_0V6	0.60V
VDD_0V3	0.30V
VDD_0V18	0.18V
VDD_0V15	0.15V
VDD_0V1	0.10V
VDD_0V05	0.05V
VDD_0V01	0.01V
VDD_PUMP	1.80V

VDD_0V18	1.80V
VDD_1V8	1.80V
VDD_1V2	1.20V
VDD_0V9	0.90V
VDD_0V6	0.60V
VDD_0V3	0.30V
VDD_0V18	0.18V
VDD_0V15	0.15V

VDD_0V18	1.80V
VDD_1V8	1.80V
VDD_1V2	1.20V
VDD_0V9	0.90V
VDD_0V6	0.60V
VDD_0V3	0.30V
VDD_0V18	0.18V
VDD_0V15	0.15V

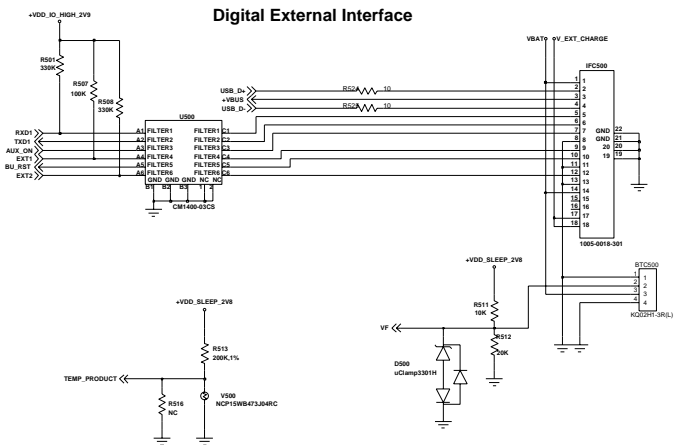

THERMISTOR

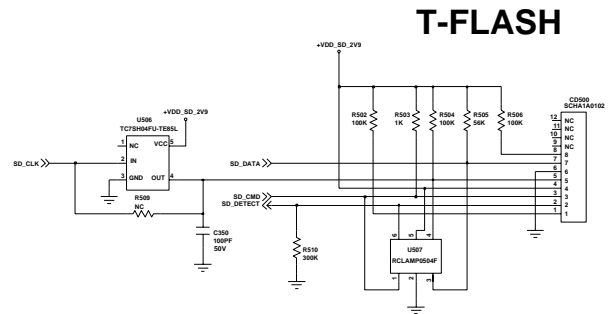

USB Interface

PCB_HOLE

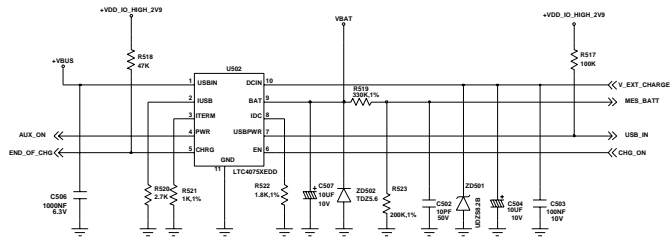
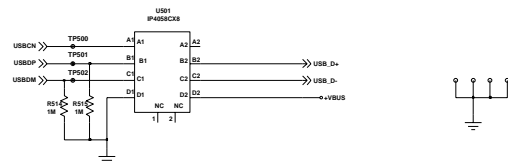

BATTERY CHARGING

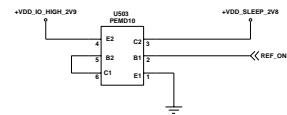

Title		
IF Connector & Charging Schematic		
Size	Document Number	Rev
A3	SAMSUNG/SGH-X700B.B1F & CHARGING	Rev 1.1
Date:	2005.10.26.	Sheet 5 of 7

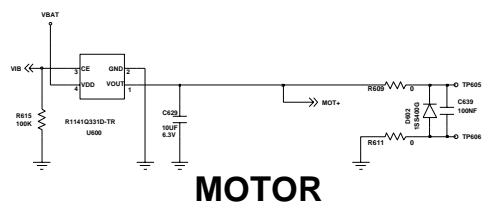
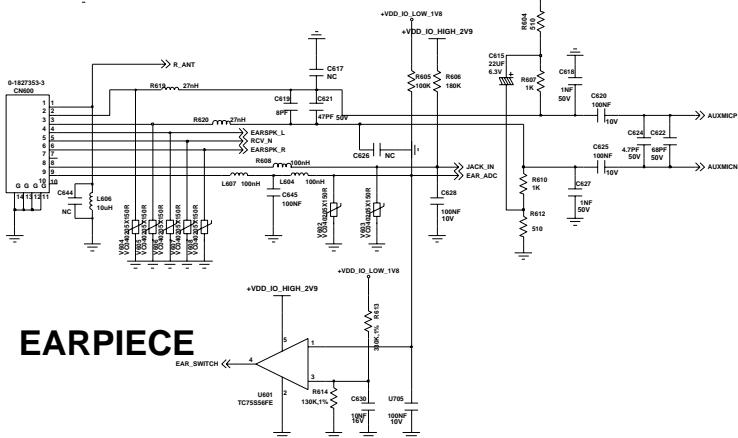
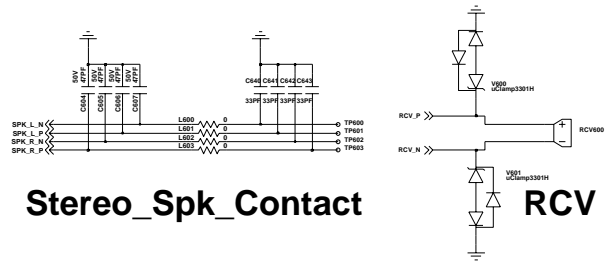
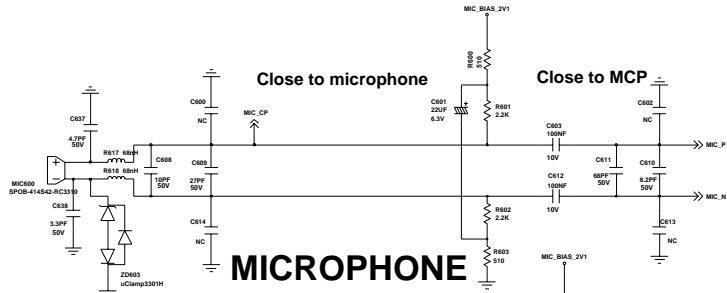

EARPIECE

MOTOR

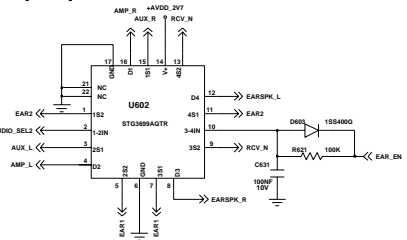

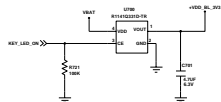
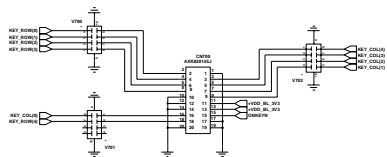

KEY BACKLIGHT

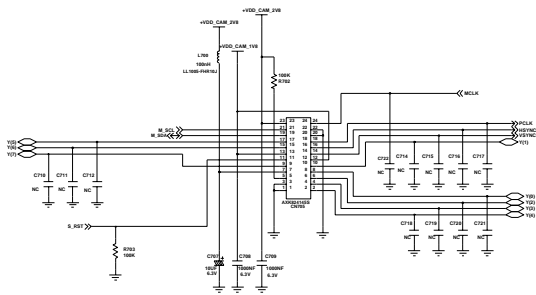

CAMERA

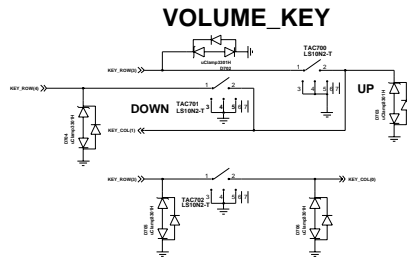

CAMERA_KEY

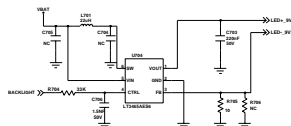
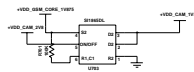

LCD BACKLIGHT

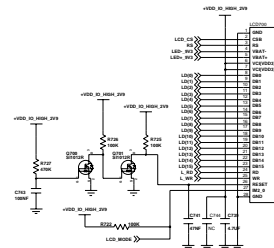

LCD CONNECTOR

