

< GSM >

	MODE		
	ANT_SEL0	ANT_SEL1	ANT_SEL2
GGM00000 TX	H	H	L
GGM00100 TX	H	L	L
GGM00000 RX	L	L	L
GGM00000 RX	L	L	H
GGM00000 RX	L	H	L
GGM00000 RX	L	H	H
UMTS 2100 RX/TX	H	L	H

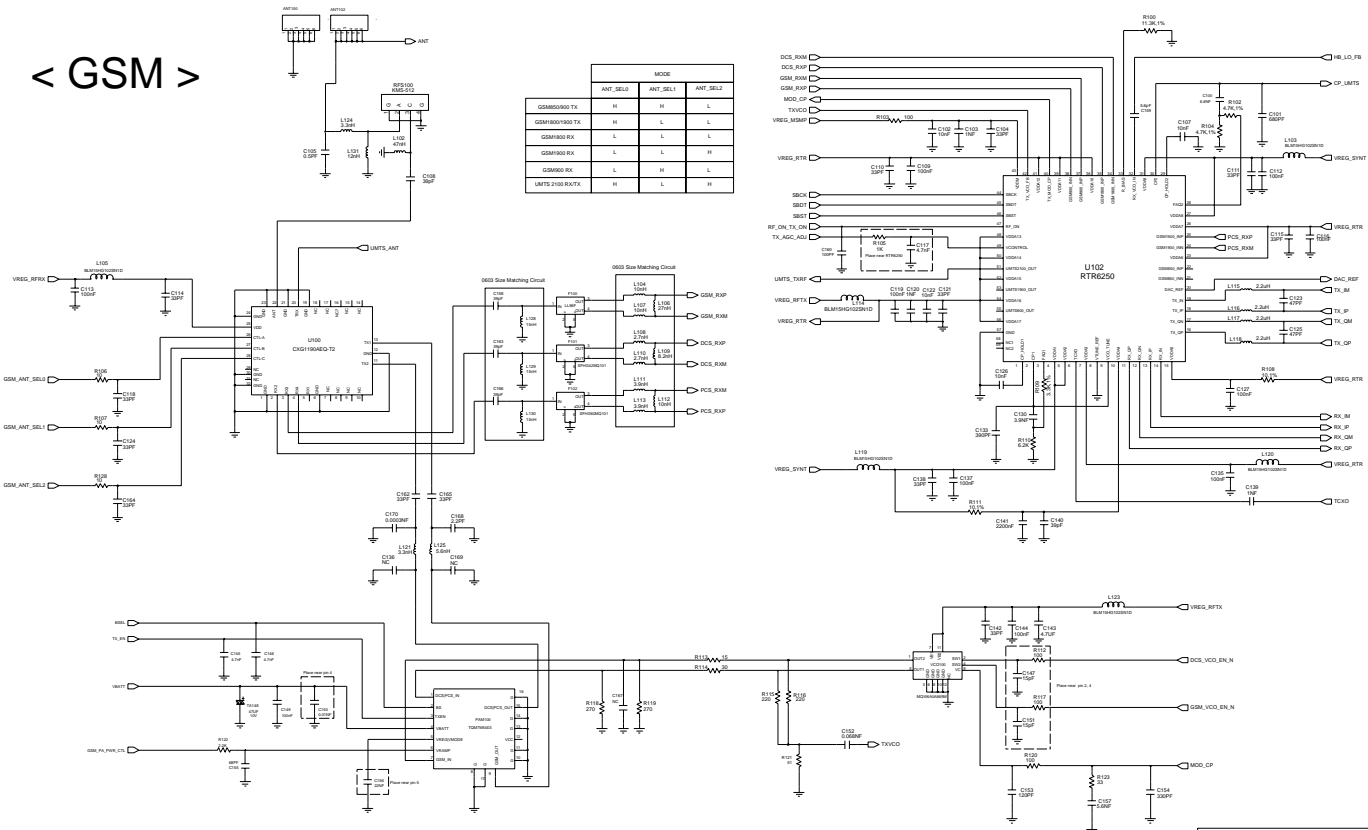

< WCDMA >

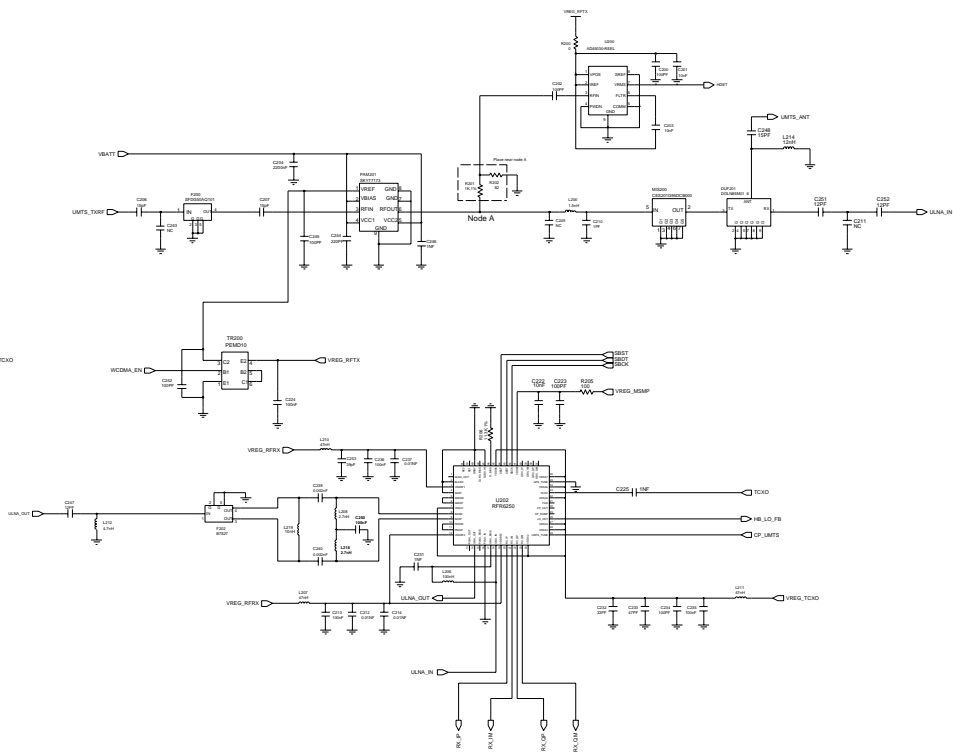
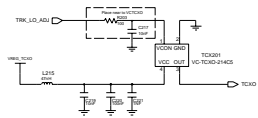

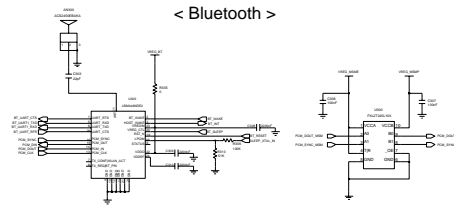
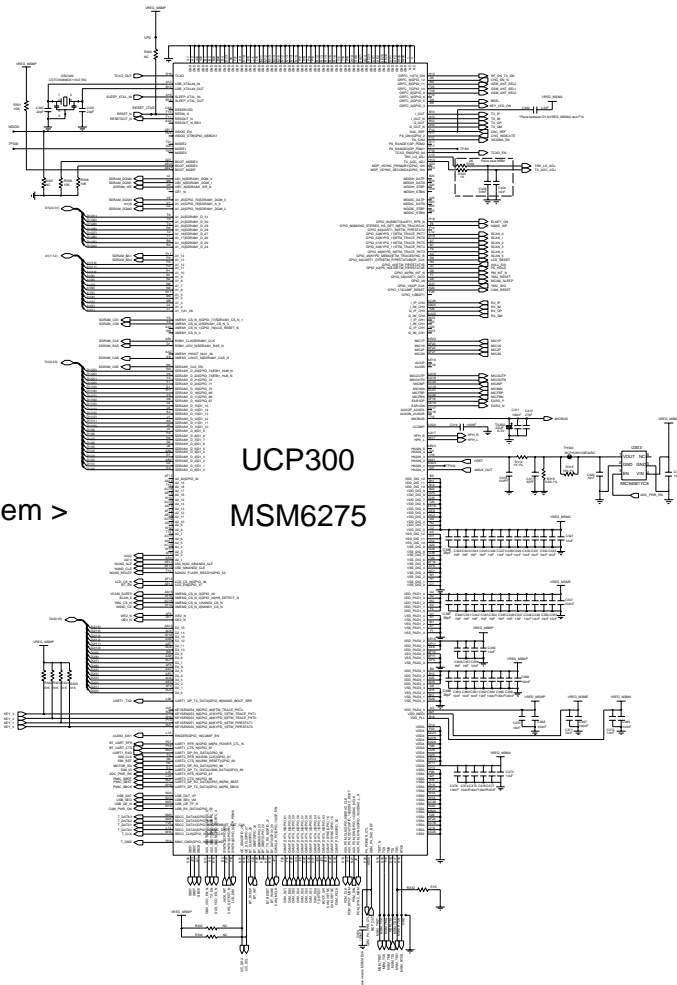

< Keypad LED Power >

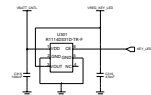

< USB Filter >

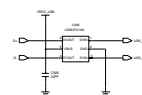

< MIC Feedback >

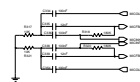

< VBATT Control >

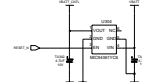

< USIM / T-Flash Connector >

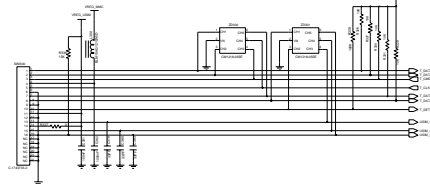

< Memory 1G / 512M >

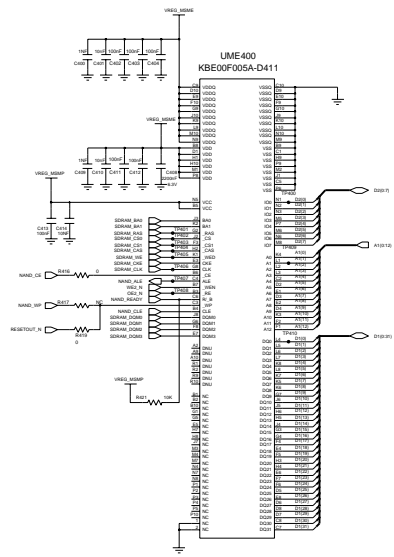

< Earjack / IF Connector >

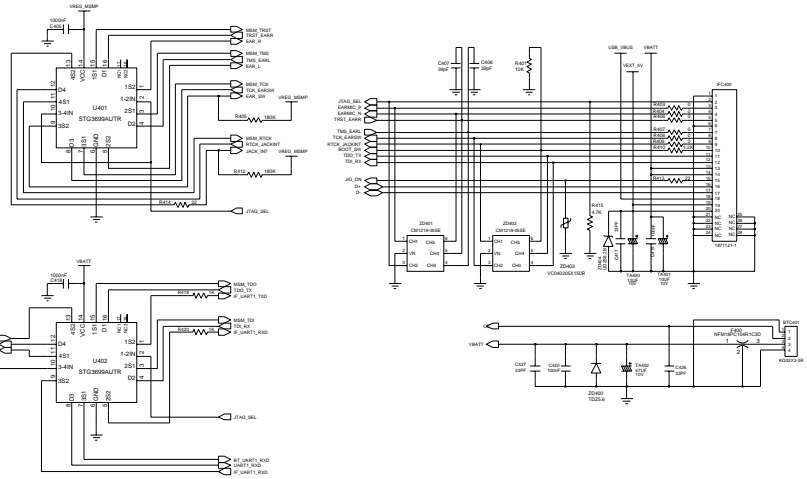

< Test JTAG PAD >

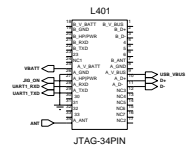

< Hall IC >

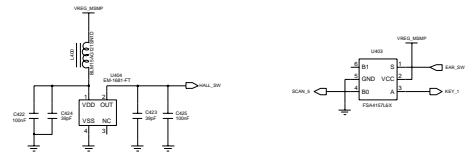



< Power Management IC >

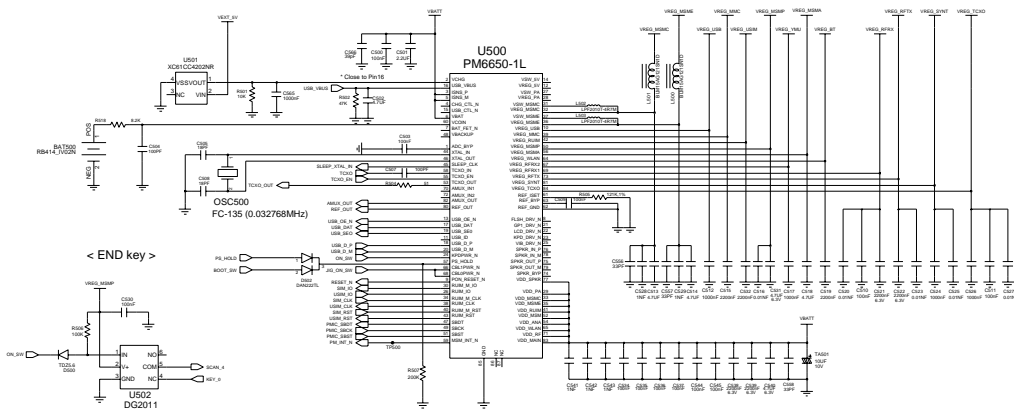

Power	Voltage
VREG_TCAD	2.80V
VREG_SF1N	2.80V
VREG_SF1P	2.80V
VREG_SF1X	2.80V
VREG_SF1	2.20V
VREG_SF2A	2.80V
VREG_SF2P	2.80V
VREG_SF2M	1.80V
VREG_SF2N	2.20V
VREG_SF2S	1.30V
VREG_SF2U	2.20V

< END key >

< Charging IC >

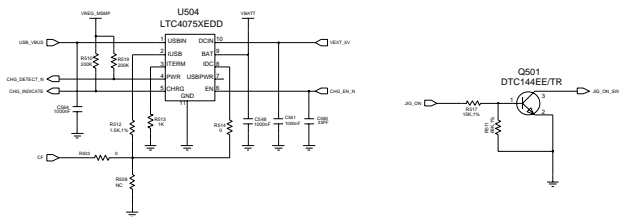

< Motor >

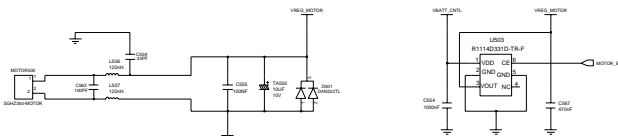

< Audio >

< Phone Mic Path >

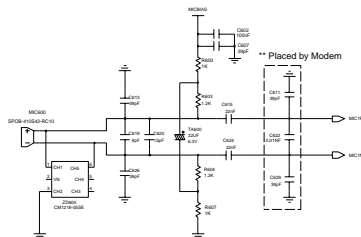

< Earphone Mic Path >

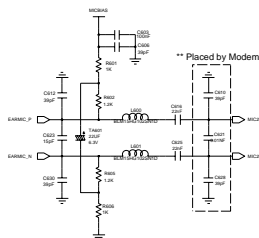

< Speaker Path >

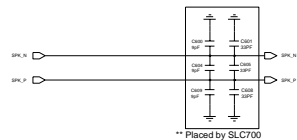

< Earphone Path >

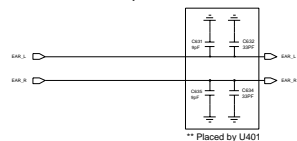

< Melody IC >

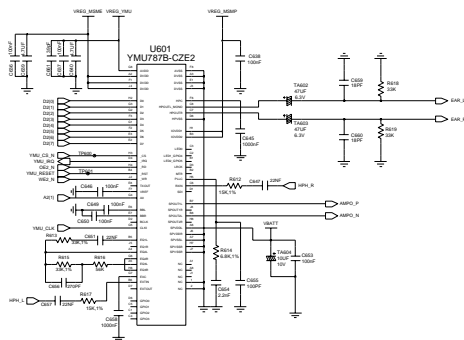
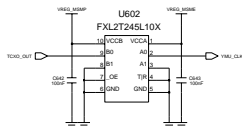

< Audio Switch 1 >

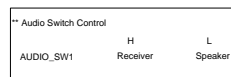
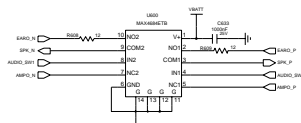

< Slide Connector >

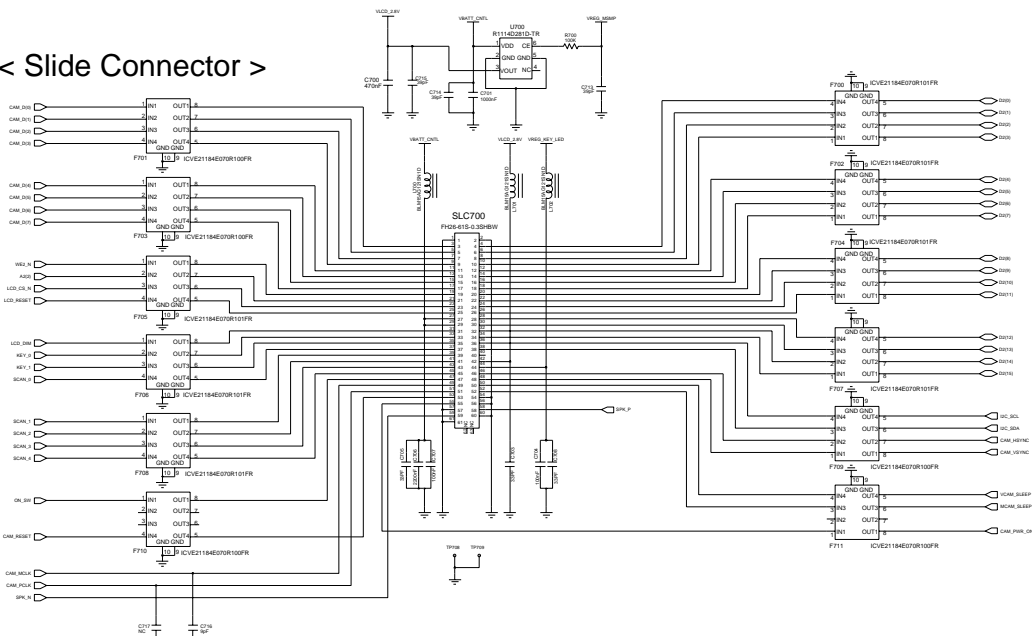

< Side Volum Key >

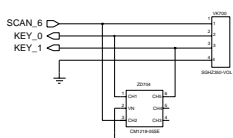

< Side Camera Key >

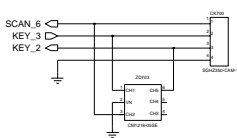

< Main Key >

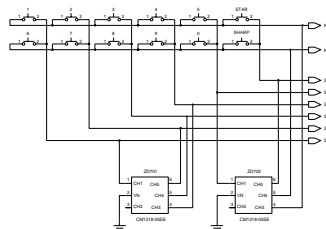

< EL KEYPAD >

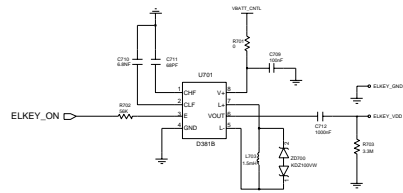

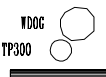
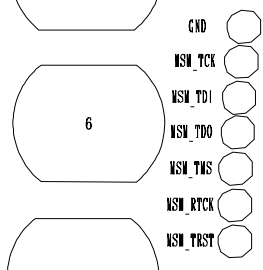
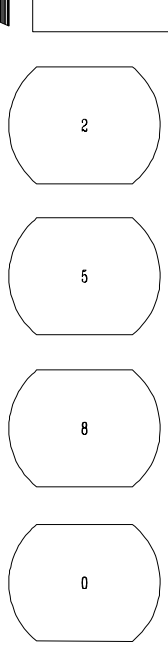
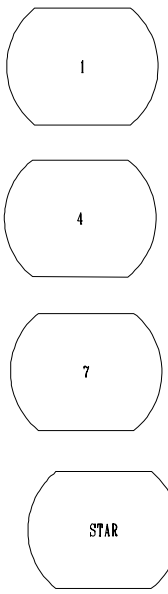
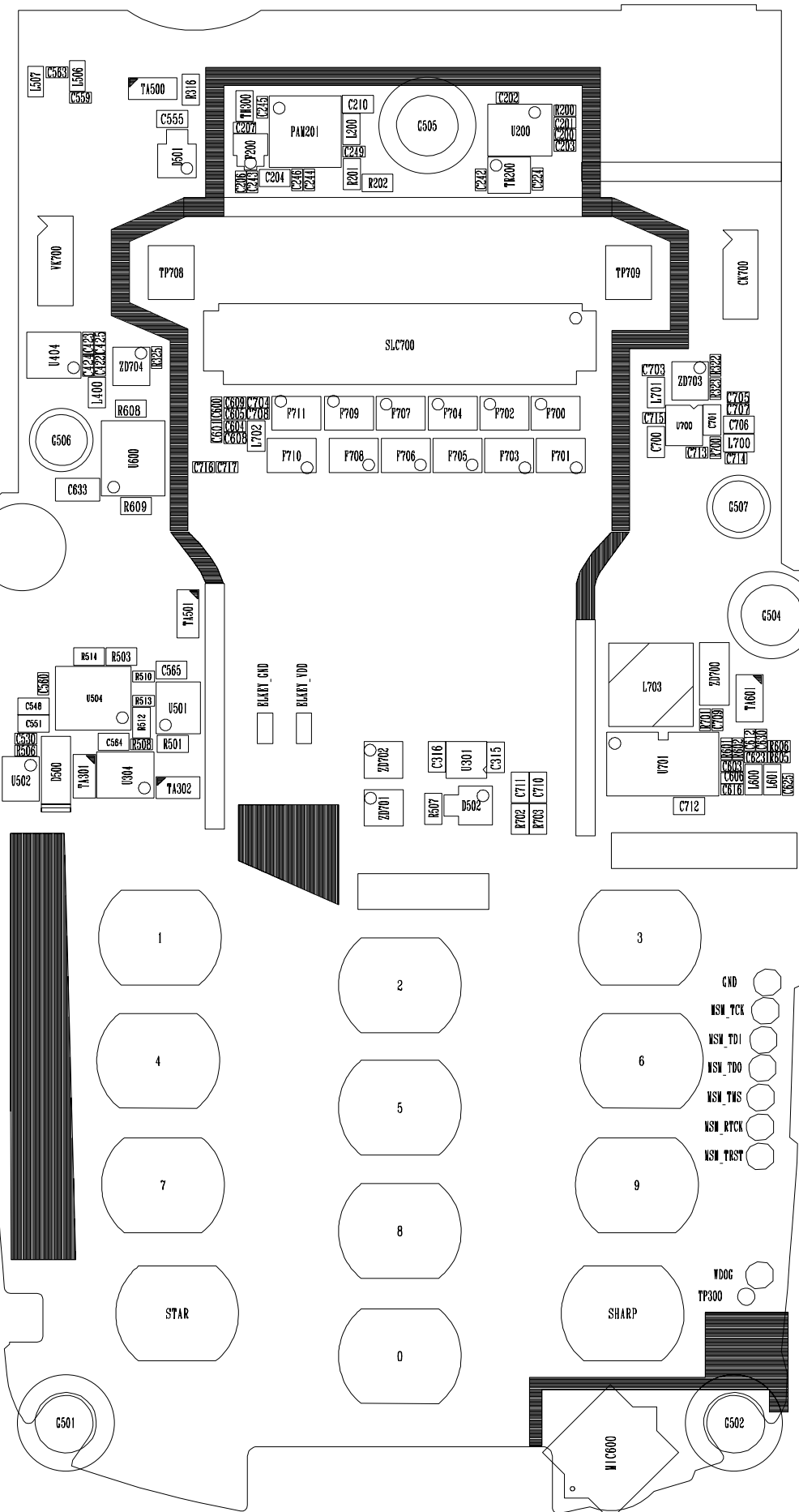

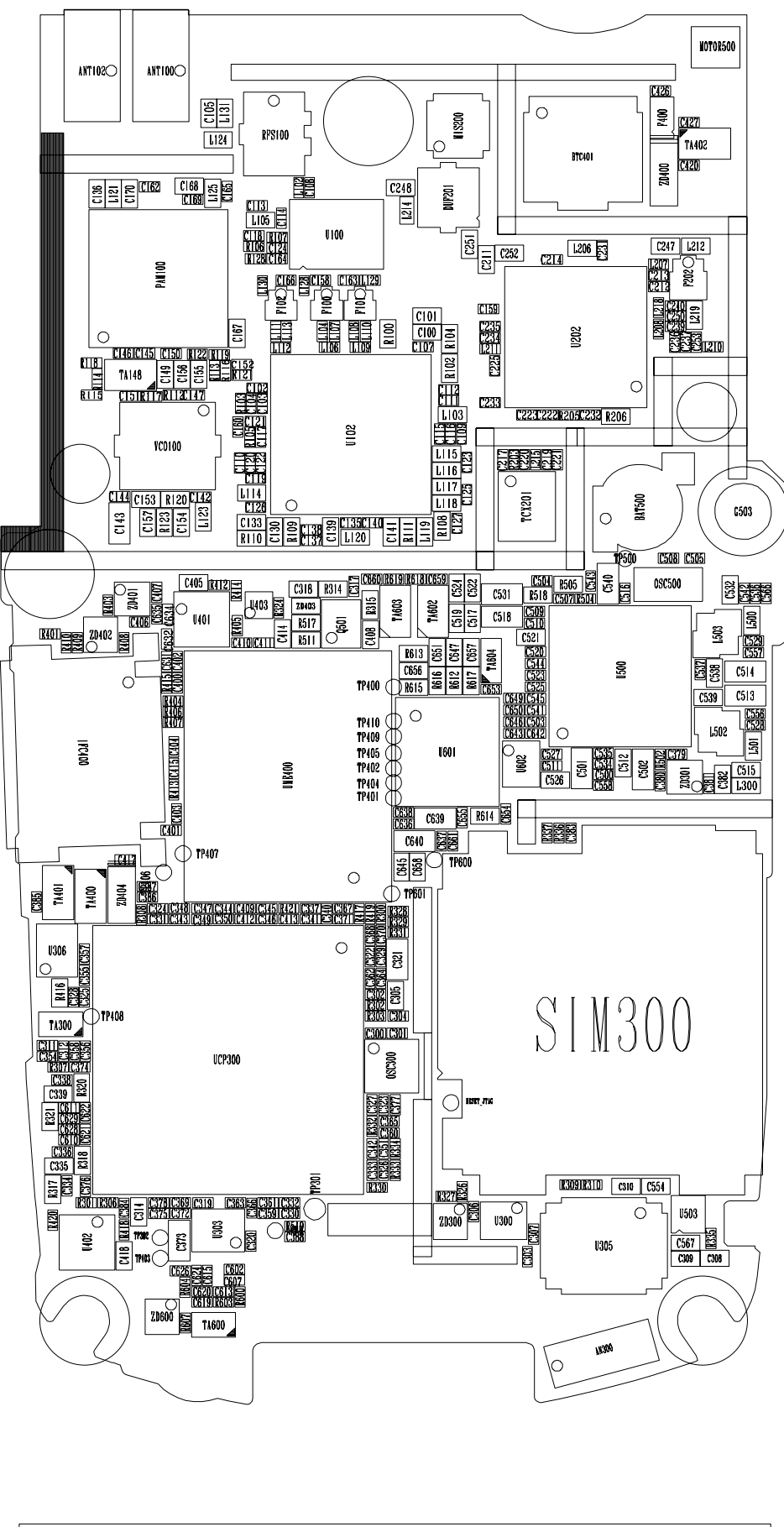

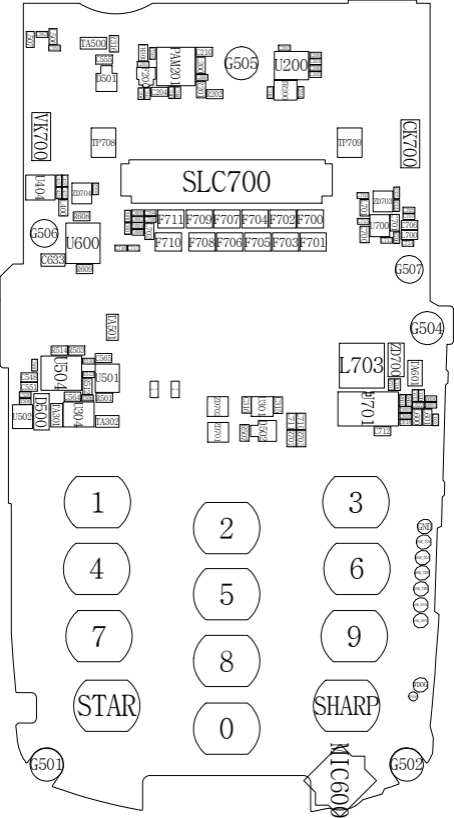

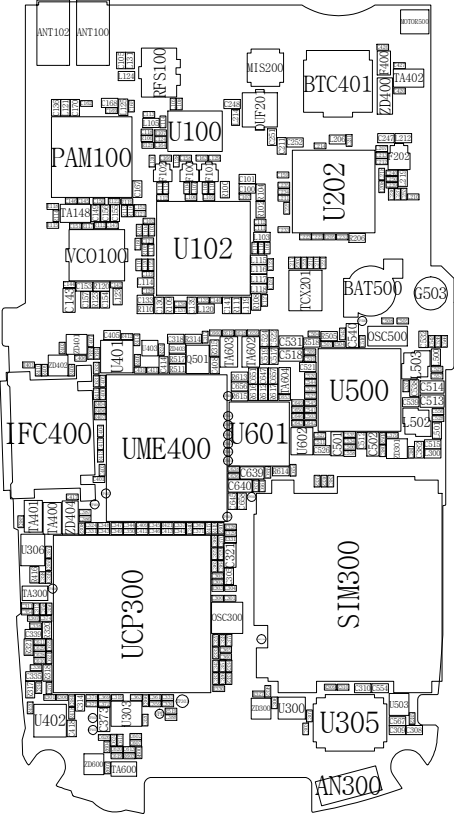

L401