

C106	7B	C365	7A	C387	7B	C474	8A	C956	6A	L452	8A	R366	7A	R951	6B	V851	6A
C107	7A	C366	8A	C388	7B	C476	8A	C957	6A	L453	8A	R368	7A	R952	6A	X251	5A
C108	7B	C367	8A	C389	7A	C481	8A	C958	6A	L454	8A	R369	7A	R953	6A	X252	5B
C110	8B	C368	8A	C390	7A	C483	7A	C959	6A	L852	6B	R370	8A	R954	6A	X271	7C
C111	7B	C369	7A	C392	7A	C484	8A	C961	6A	L853	6B	R390	8A	R955	6B	X450	9A
C113	7B	C370	8A	C393	7A	C487	8A	C968	6B	L874	2B	R391	7A	R957	6A	X2253	9B
C157	7B	C371	7A	C399	7A	C490	9A	C1173	7B	L8871	3B	R395	7A	R958	6A	Z171	7B
C158	7B	C372	7A	C450	8A	C847	6B	C3364	9C	N450	8A	R396	7A	R959	6A	Z850	6B
C160	8B	C373	7A	C451	7A	C851	6B	C3365	9C	R101	7A	R399	7A	R960	6A	Z851	6B
C164	7A	C375	7A	C452	8A	C855	6B	C3367	9C	R102	7A	R457	9A	R961	6A	Z950	6A
C165	7B	C376	7A	C453	8A	C856	6B	C3369	8C	R103	7B	R843	6B	R962	6A		
C171	7B	C377	7A	C455	9A	C857	6B	C8870	3B	R104	8B	R850	6B	R963	6B		
C172	7B	C379	7A	C456	8A	C858	6B	C8874	2B	R105	7B	R851	6B	R1500	9C		
C242	2A	C380	7A	C457	9A	C859	6B	D102	8B	R158	7B	R853	6B	R8872	2B		
C245	3A	C381	7A	C458	7A	C860	6B	D105	8B	R159	7B	R854	6B	R8873	2B		
C356	6A	C382	7A	C459	9A	C873	2B	D171	8B	R161	7A	R855	6B	R9963	6B		
C361	8A	C383	7A	C460	8A	C950	6B	D361	7A	R362	6A	R857	6B	V151	7B		
C362	7A	C384	7A	C470	8A	C952	6A	D450	9A	R363	6A	R858	6B	V361	6A		
C363	7A	C385	7A	C471	8A	C953	6A	L450	8A	R364	7A	R859	6B	V850	6B		
C364	8A	C386	7B	C473	8A	C954	6B	L451	8A	R365	7A	R950	6B	V950	6A		

Confidential
Copyright © Siemens AG

Achtung : Höhenprofil C24-42 (gilt nur fuer Entwicklung)
Liefervarianten siehe : V24851-Z2000-A1-4-35

Datum		21.03.2001
Bearb.	Lange	
Gepr.	MP RD KLF7	
Norm		
10	995	18.10.2002
9	993	12.09.2002
8	980	27.08.2002
7	978	30.07.2002
Zust.	Mitteilung	Datum
Name		
L55 Mainboard		
Marlin Bluetooth B2.1		
WIRING DIAGRAM (SOLDER SIDE 1)		
Siemens AG		
8609		
Blatt		
1+		
Created by BOM number: A5B00900112136-995		

PROPRIETARY DATA, COMPANY CONFIDENTIAL
ALL RIGHTS RESERVED

ALLE RECHTE VORBEHALTEN
ALS BETRIEBSGEHEIMNIS ANVERTRAUT

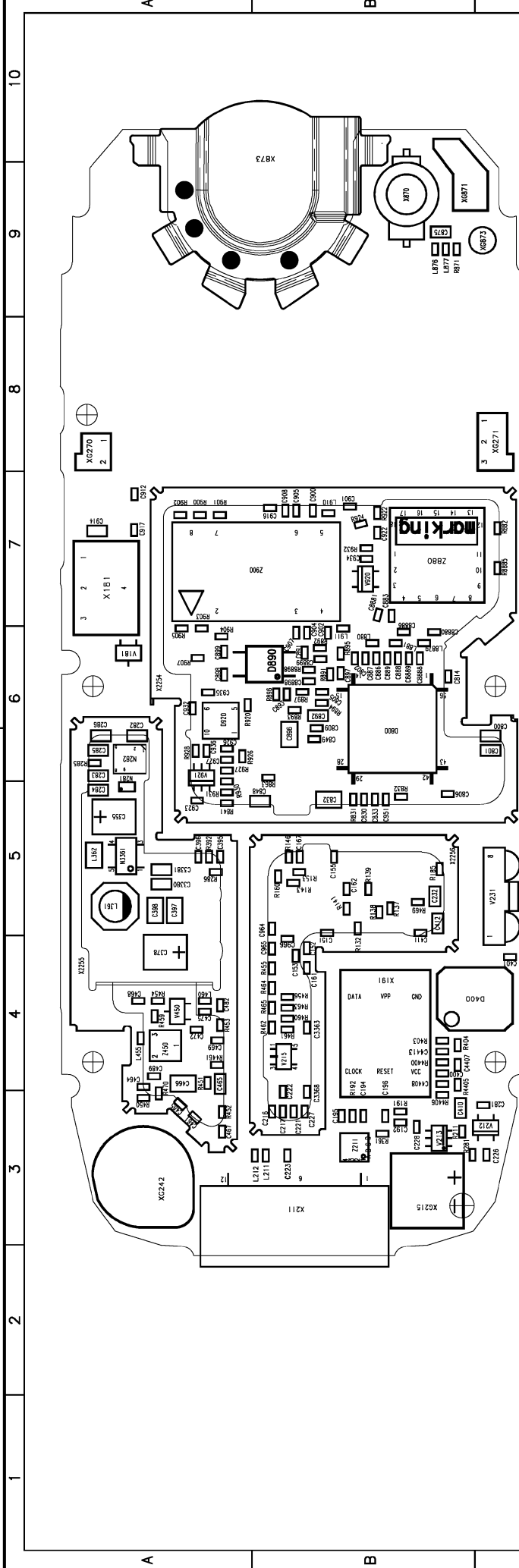

C151	5B	C281	3C	C466	4A	C849	6B	C908	7B	C3381	5A	L460	4A	R185	5B	R461	4B	R900	7A	R8885	7C	Z880	7B
C152	4B	C282	6A	C467	3A	C875	9B	C912	7A	C4407	4B	L876	9B	R191	3B	R462	4B	R901	7A	R8898	6B	Z900	7A
C153	5B	C284	5A	C469	4A	C886	6B	C916	7B	C4413	4B	L880	6B	R192	3B	R463	4B	R902	7A	V181	6A		
C161	4B	C285	6A	C472	4A	C887	6B	C917	7A	C8880	6B	L881	6B	R281	3B	R464	4B	R903	6A	V212	3C		
C162	5B	C286	6A	C475	4A	C888	6B	C922	7B	C8881	7B	L910	7B	R285	6A	R465	4B	R904	6A	V213	3B		
C167	5B	C355	5A	C482	4A	C889	6B	C923	5A	C8886	6B	L911	6B	R286	5A	R469	5B	R905	6A	V215	4B		
C192	3B	C378	4A	C485	3A	C891	6B	C926	6A	C8888	6B	L8879	6B	R361	3B	R831	5B	R920	6A	V450	4A		
C194	3B	C395	5A	C489	4A	C892	6B	C927	6A	C8889	6B	N281	5A	R392	5A	R832	5B	R922	7B	V920	7B		
C195	3B	C396	5A	C800	6C	C893	6B	C932	6A	C8898	6B	N282	6A	R403	4B	R841	5A	R924	7B	V921	5A		
C196	3B	C397	5A	C801	6C	C896	6B	C934	7B	C8899	6B	N3361	5A	R404	4B	R863	6B	R926	6A	X181	7A		
C216	3B	C398	5A	C802	6B	C897	6B	C935	6A	D400	4B	R132	5B	R450	3A	R871	9B	R927	6A	X191	4B		
C217	3B	C400	4B	C805	6B	C898	6A	C936	6A	D800	6B	R137	5B	R451	4A	R882	7C	R928	5A	X211	3B		
C221	3B	C401	4C	C806	5B	C899	6A	C951	5B	D890	6A	R138	5B	R452	3A	R891	6B	R930	5A	X870	9B		
C222	3B	C410	3B	C809	6B	C900	7B	C964	5B	D920	6B	R139	5B	R453	4A	R892	6B	R931	5A	X873	10B		
C223	3B	C411	5B	C814	6B	C901	7B	C965	4B	L211	3B	R141	5B	R454	4A	R893	6B	R932	7B	X2254	5A		
C226	3C	C412	5B	C830	5B	C902	6B	C966	4B	L212	3B	R143	5B	R455	4B	R894	6B	R4400	4B	X2255	5A		
C227	3B	C461	3A	C832	5B	C904	6B	C3363	4B	L361	5A	R146	5B	R456	4B	R895	6B	R4405	4B	X2256	5A		
C228	3B	C464	4A	C833	5B	C905	7B	C3368	3B	L362	5A	R153	5B	R459	4A	R896	6B	R4406	3B	Z211	3B		
C232	5B	C465	3A	C848	5A	C907	6B	C3380	5A	L455	4A	R160	5B	R460	4B	R897	6B	R4461	4A	Z450	4A		

Confidential
 Copyright © Siemens AG

Achtung : Höhenprofil C24...42 (gilt nur fuer Entwicklung)
 Liefervarianten siehe : V24851-Z2000-A1-4-35

		Datum		21.03.2001	
		Beerb.		Lange	
		Gepr.		MP RD KLF7	
		Norm			
10		995		18.10.2002	
9		993		12.09.2002	
8		980		27.08.2002	
7		978		30.07.2002	
Zust.		Mittelung		Datum	
1		2		3	
4		5		6	
7		8		9	
10		11		12	
		L55 Mainboard		3:1	
		Marlin Bluetooth B2.1		Blatt	
		WIRING DIAGRAM (SOLDER SIDE 2)		8609	
		Siemens AG		Siemens AG	
		Created by BOM number: A5B0090012136-995			

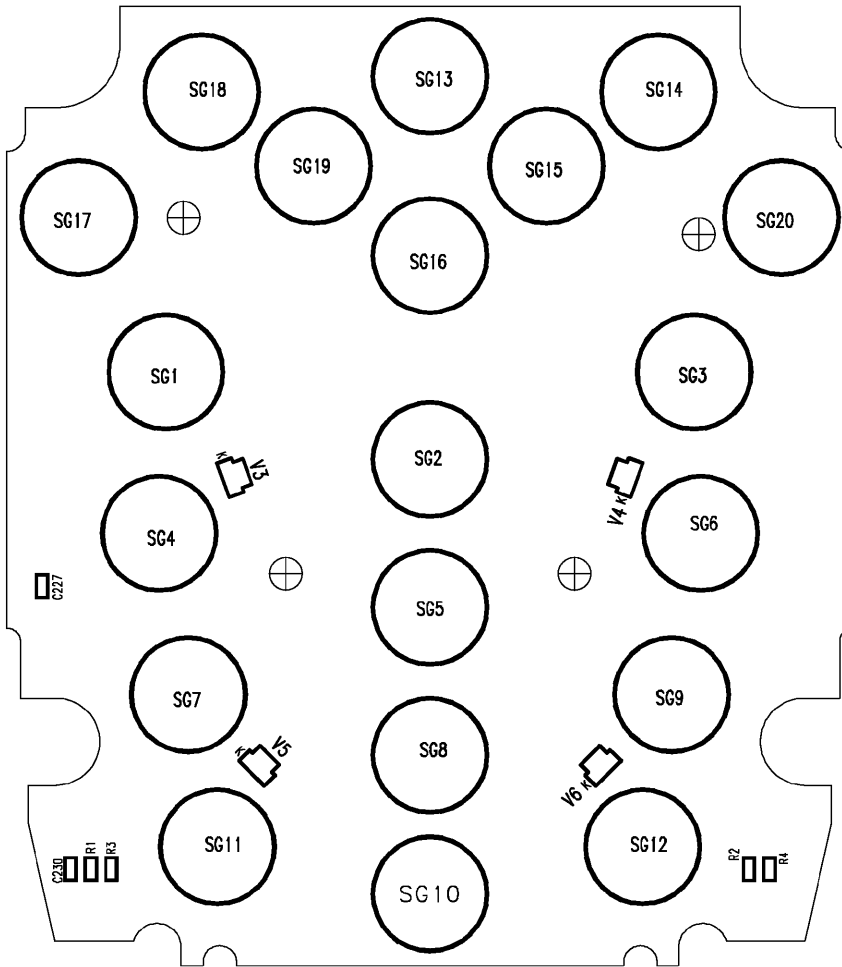

C227	1B
C230	1C
R1	1C
R2	4C
R3	1C
R4	4C
V3	2B
V4	3B
V5	2C
V6	3C

Achtung : Höhenprofil C24____-____-____-42 (gilt nur fuer Entwicklung)
Liefervarianten siehe : V24851-Z2000-A1--35

Confidential
Copyright © Siemens AG

				Datum	29.04.2002	L55 MMI Assembled with 4 LED WHITE WIRING DIAGRAMM (SOLDER SIDE 1)	3:1
				Bearb	Horn		
				Gepr.			
				Norm			
				MP POB RD MCH72			
2	1056	09.07.2002	HH	Siemens AG		13580	Blatt
1	582	29.04.2002	HH				1+
Zust.	Mitteilung	Datum	Name	(Created by BOM number: A5B00900105523-1056)			

- TP367 7A
- TP452 10A
- TP840 7B
- TP841 6B
- TP850 7B
- TP950 7A

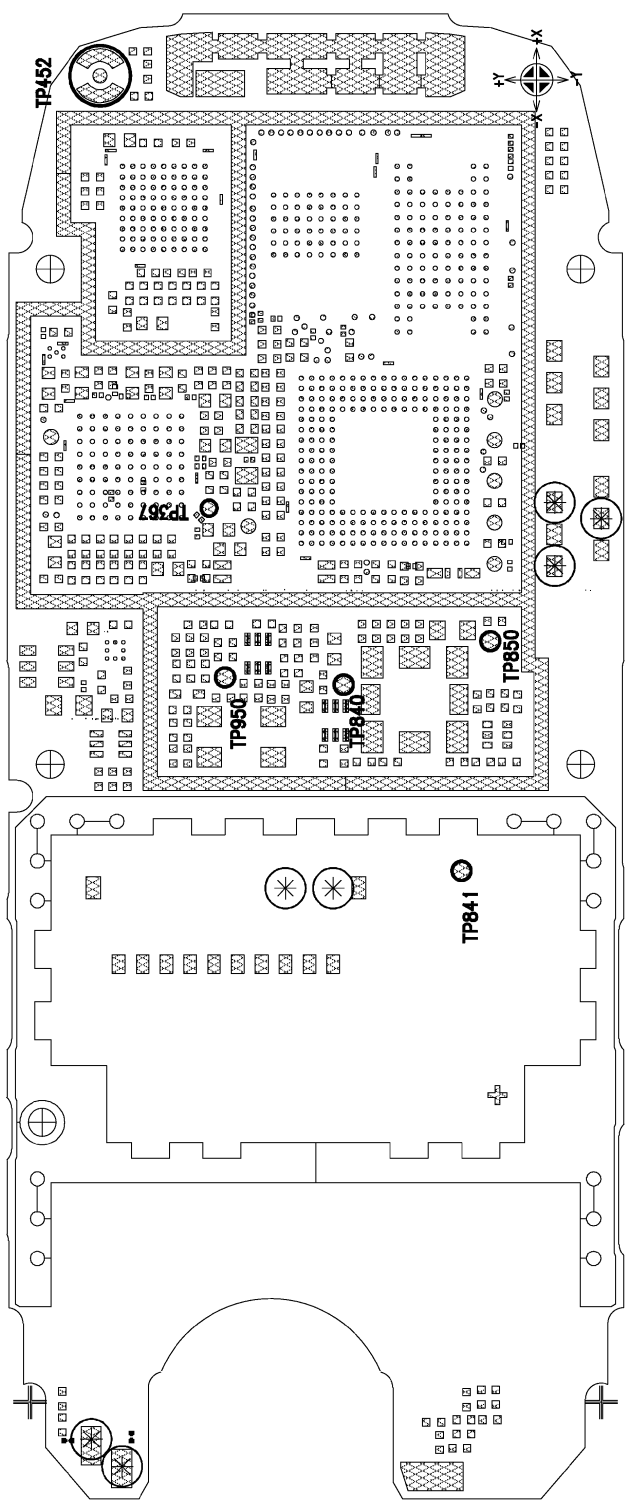

Confidential
 Copyright © Siemens AG

L55 Mainboard		21.03.2001		Date	
Marlin Bluetooth B2.1		Lange		Date	
TESTPOINT DIAGRAM (SIDE 1)		MP RD KLF7		Date	
3:1		Gepr.		Date	
Blatt		Norm		Date	
1+		Lge		Date	
Siemens AG		Lge		Date	
8610		Str		Date	
Created by BOM number: A5B00900101015-978		Lge		Date	
		Name		Date	
		Zust.		Date	
		Mittelung		Date	

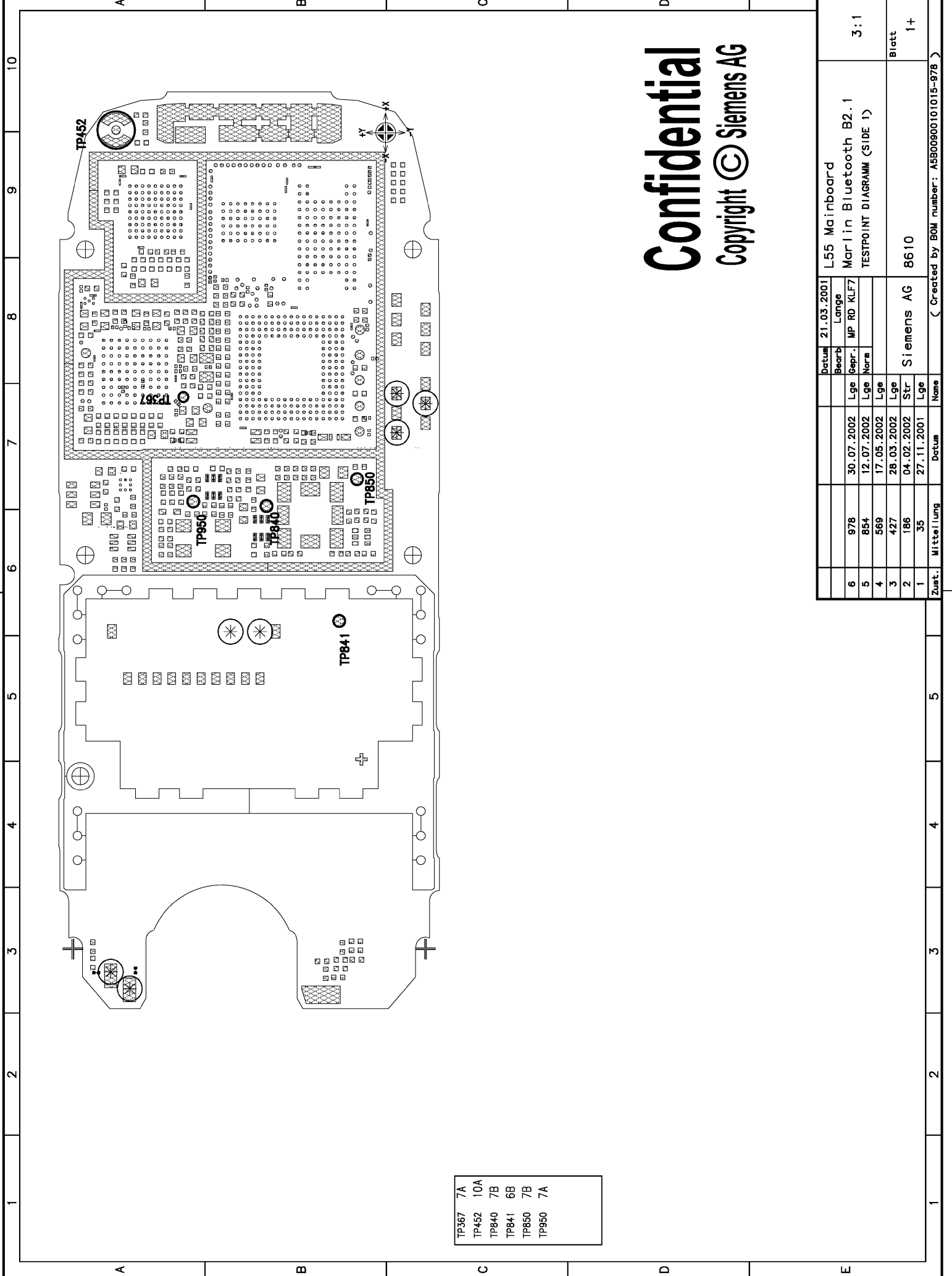

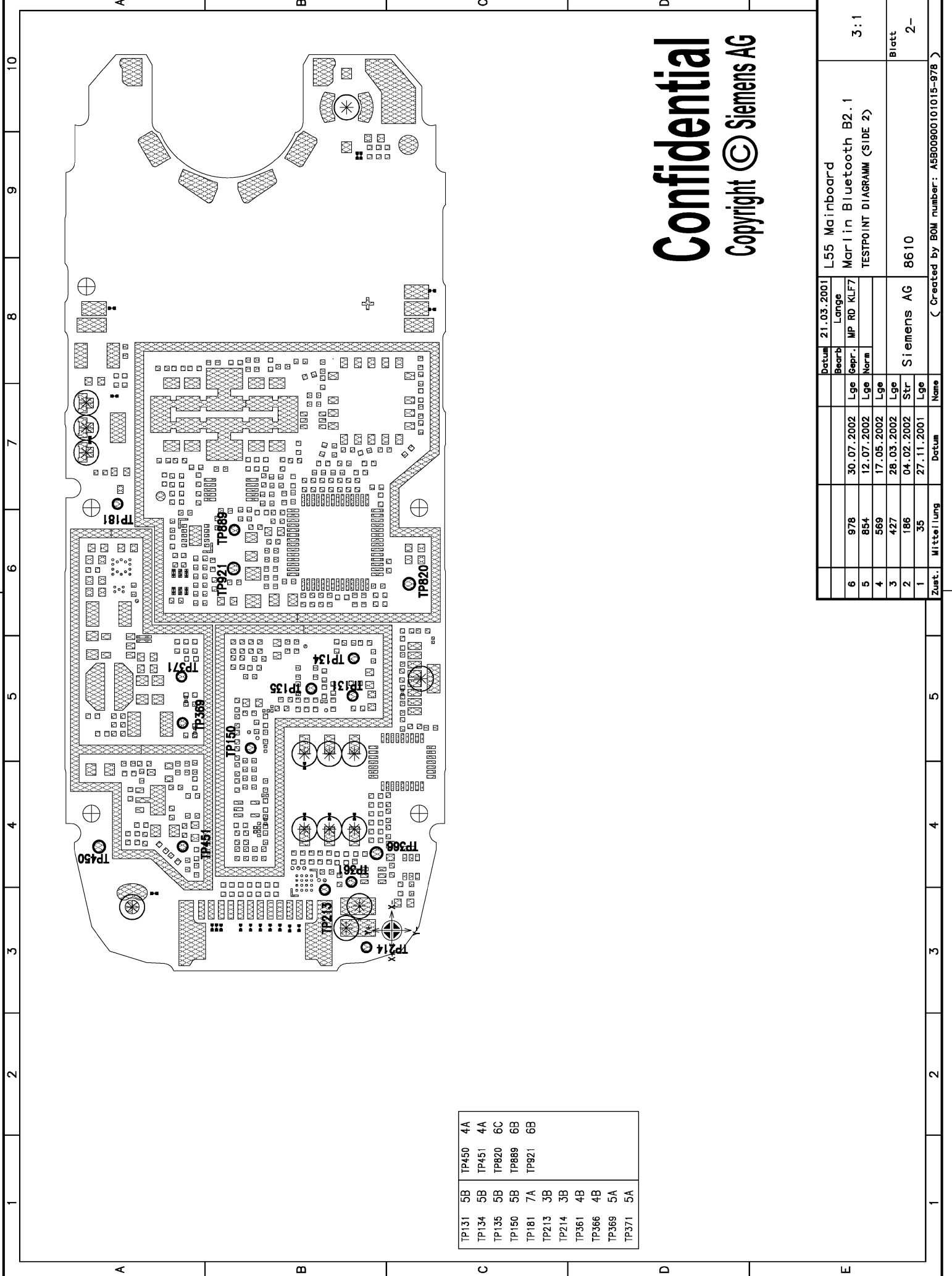

TP131	5B	TP450	4A
TP134	5B	TP451	4A
TP135	5B	TP820	6C
TP150	5B	TP889	6B
TP181	7A	TP921	6B
TP213	3B		
TP214	3B		
TP361	4B		
TP366	4B		
TP369	5A		
TP371	5A		

Confidential
 Copyright © Siemens AG

L55 Mainboard		21.03.2001		Date	
Marlin Bluetooth B2.1		Beerb.		Lange	
TESTPOINT DIAGRAM (SIDE 2)		Gepr.		MP RD KLF7	
		Lge			
		Lge			
		Lge			
Siemens AG		04.02.2002		Str	
8610		27.11.2001		Lge	
		Datum		Name	
Zust.		Mittelung		5	
1		4		3	
2		2		4	
3		3		5	
4		4		6	
5		5		7	
6		6		8	
7		7		9	
8		8		10	
9		9		A	
10		10		B	
A		A		C	
B		B		D	
C		C		E	
D		D			
E		E			

PROPRIETARY DATA, COMPANY CONFIDENTIAL
ALL RIGHTS RESERVED

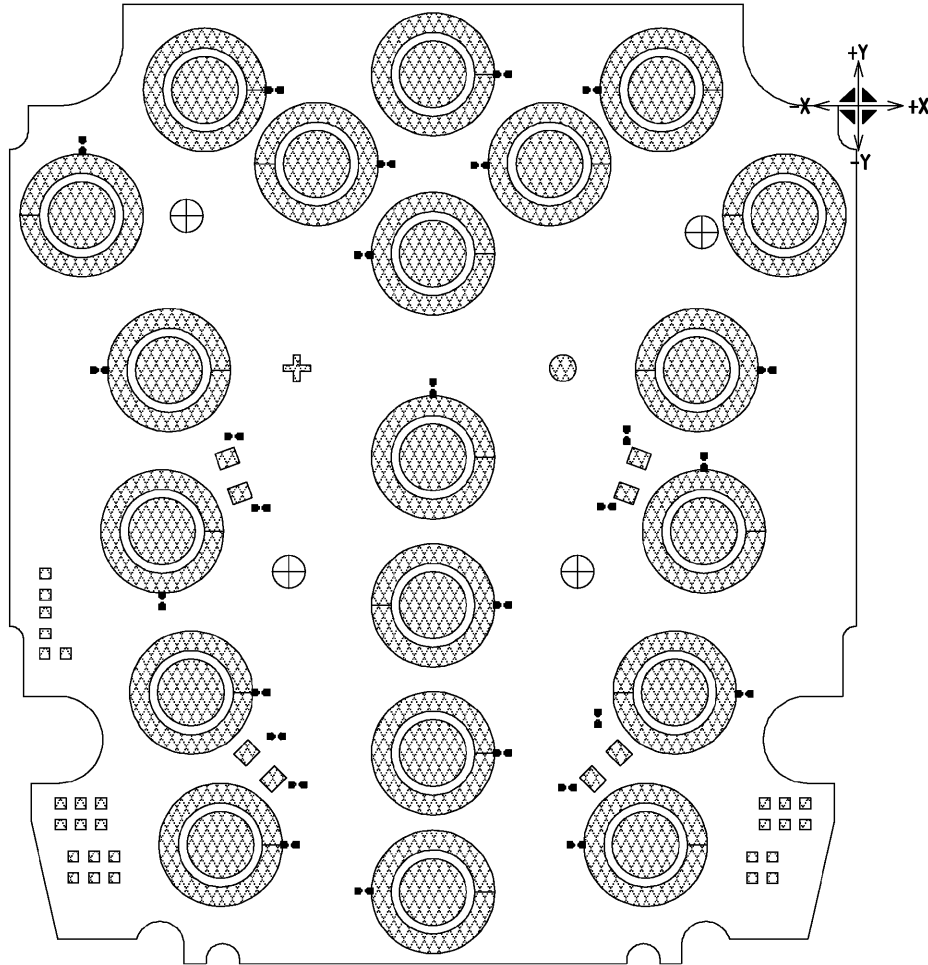

ALS BETRIEBSGEHEIMNIS ANVERTRAUT
ALLE RECHTE VORBEHALTEN

Confidential
Copyright © Siemens AG

				Datum	29.04.2002	L55 MMI Assembled with 4 LED WHITE TESTPOINT DIAGRAMM (SIDE 1)	3:1
				Bearb	Horn		
				Gepr.			
				Norm			
				MP P08 RD MCH72			
2	1056	09.07.2002	HH	Siemens AG		13581	Blatt
1	582	29.04.2002	HH				1+
Zust.	Mitteilung	Datum	Name	(Created by BOM number: A5B00900105523-1056)			

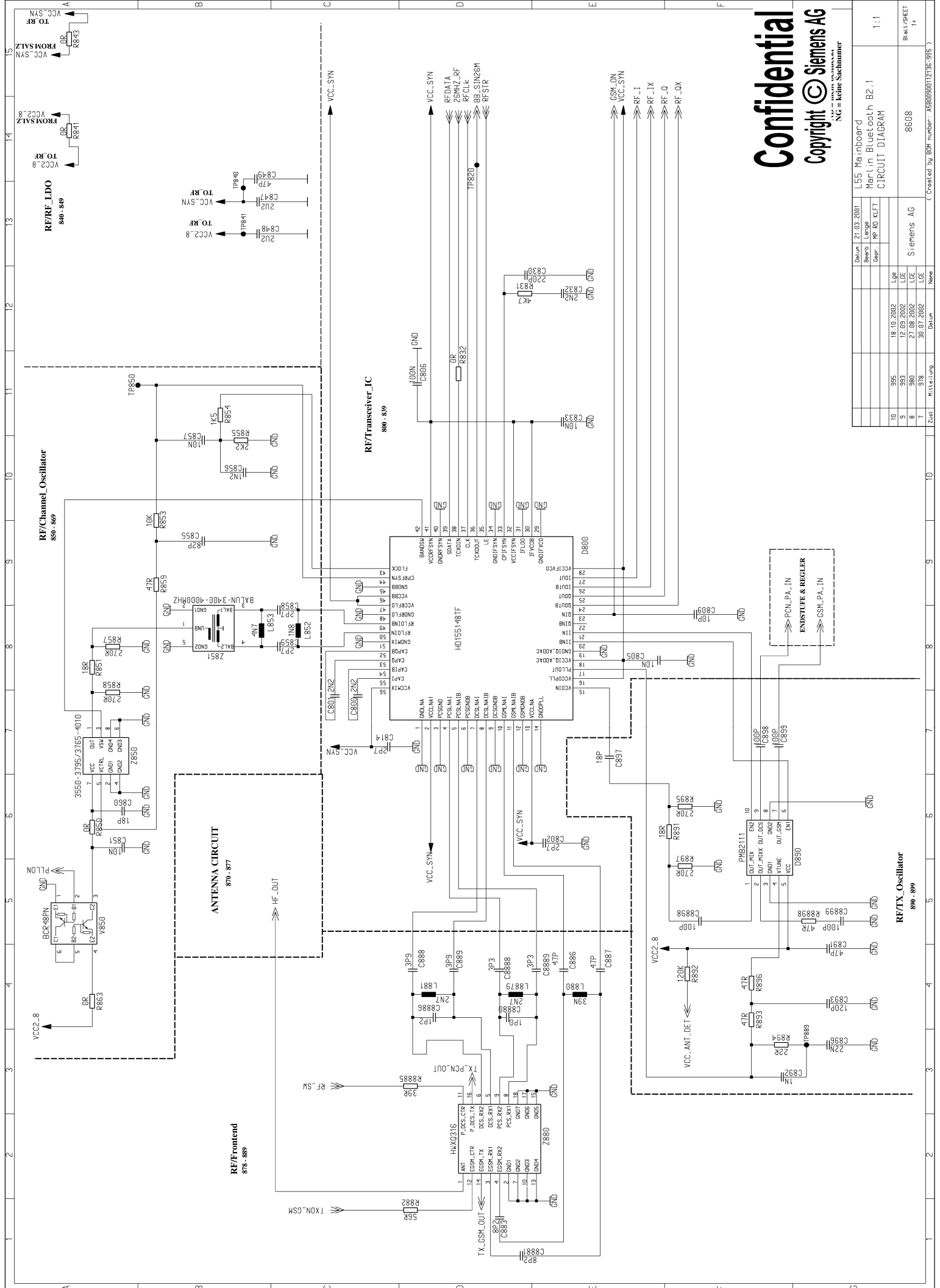

Proprietary data, Company confidential.
 alle Rechte vorbehalten

Als Betriebsgeheimnis anvertraut

Confidential
 Copyright © Siemens AG
 NG = keine Sachnummer

Date		Description	
Verf.	Gepr.	Bezeichnung	Gr.
10	995	18.10.2002	Lge
9	993	12.09.2002	LCE
8	980	21.08.2002	LCE
7	976	30.07.2002	LCE
		Wartung	
Zust.			

L55 Mainboard		1:1	
Marlin Bluetooth B2.1		Blatt/SHEET	
CIRCUIT DIAGRAM		1+	
Siemens AG		8608	
NG = keine Sachnummer		(Created by BOM number: A50009011365_955)	

RF/PA
900 - 919

RF/Power_Control
920 - 949

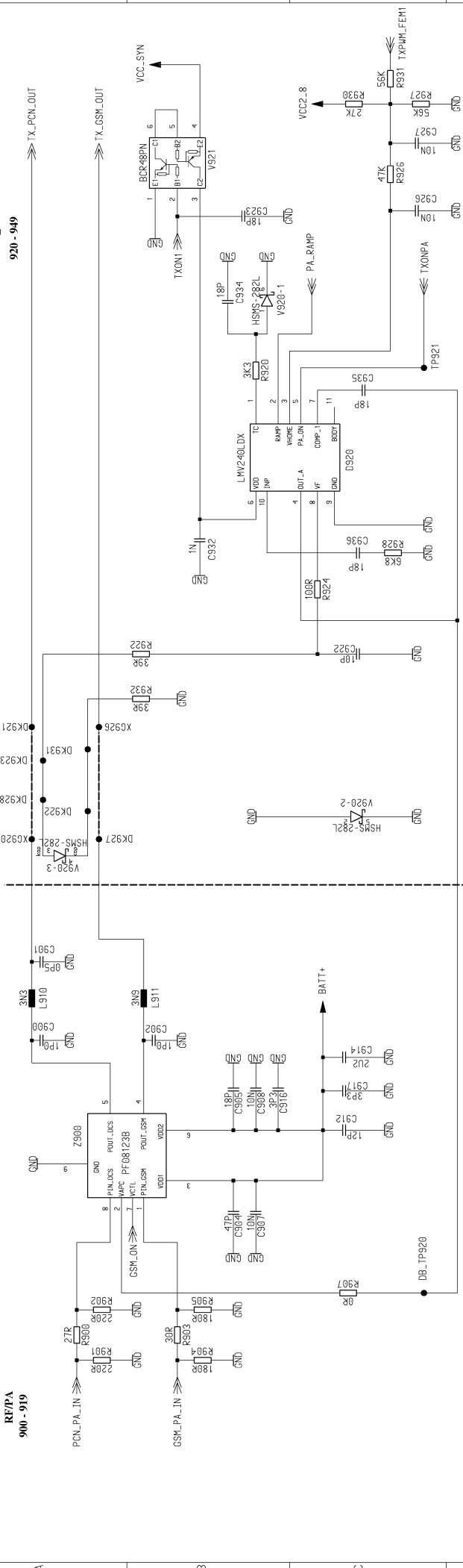

RF/Crystal_Oscillator
950 - 999

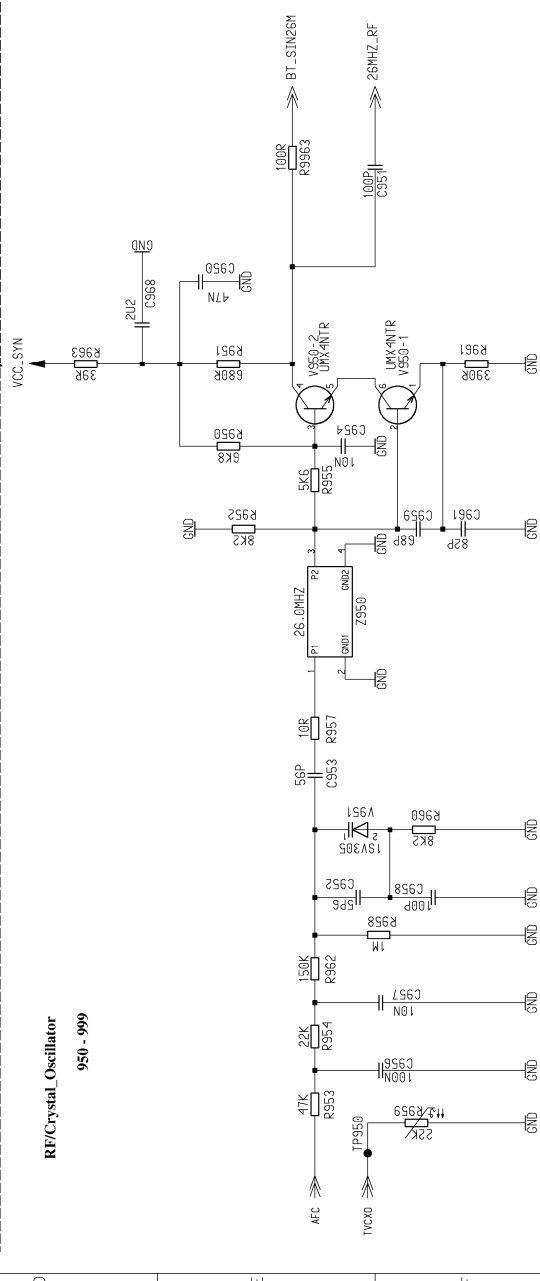

Proprietary data, Company confidential.
all rights reserved

Alle Rechte vorbehalten
Siemens AG

Confidential
Copyright © Siemens AG

NP = nicht bestückt
NG = keine Sachnummer

Date		Description	
Verf.	Gepr.	Bezeichnung	Umfang
10	995	L55 Mainboard	1:1
9	993	Marlin Bluetooth B2.1	
8	980	CIRCUIT DIAGRAM	
7	915	Siemens AG	
6	915	8608	
5	915	Blatt/SHEET	2+
4	915	Blatt/SHEET	2+
3	915	Blatt/SHEET	2+
2	915	Blatt/SHEET	2+
1	915	Blatt/SHEET	2+

Logic/Battery_Interface 181-185

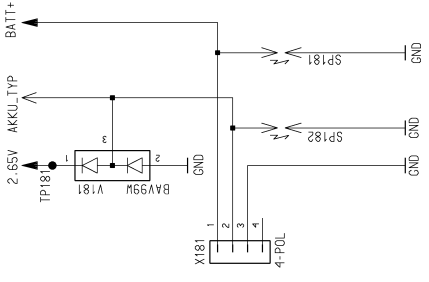

Logic/Speaker_Circuit 241-250

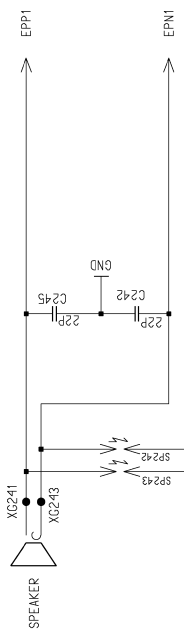

Logic/Display_Interface 251-270

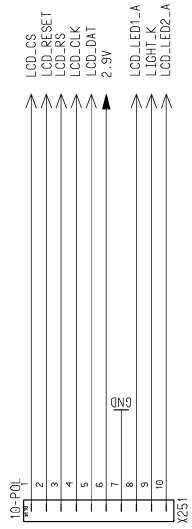

Display_Frame

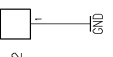

SIDEKEYS 270-275

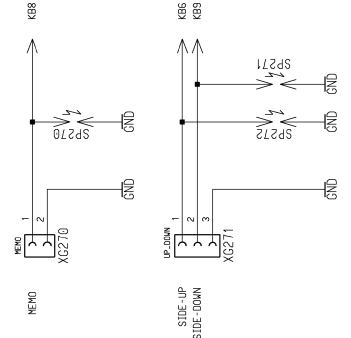

L55 Mainboard Marlin Bluetooth B2.1 CIRCUIT DIAGRAM		
Datum	21.03.2001	
Bearb	Langbe	
Gepr.	HP RD KLF7	
Lfd	18.10.2002	Name
LCE	12.09.2002	
LCE	21.08.2002	
LCE	30.01.2002	
Zust	Wartung	Datum
995		
993		
980		
976		
8608	Siemens AG	
BlaL/SHEET	3*	
(Created by BOM number: A5B050801121365_995)		

INTERFACE LOGIK/HF
2450 - 2499

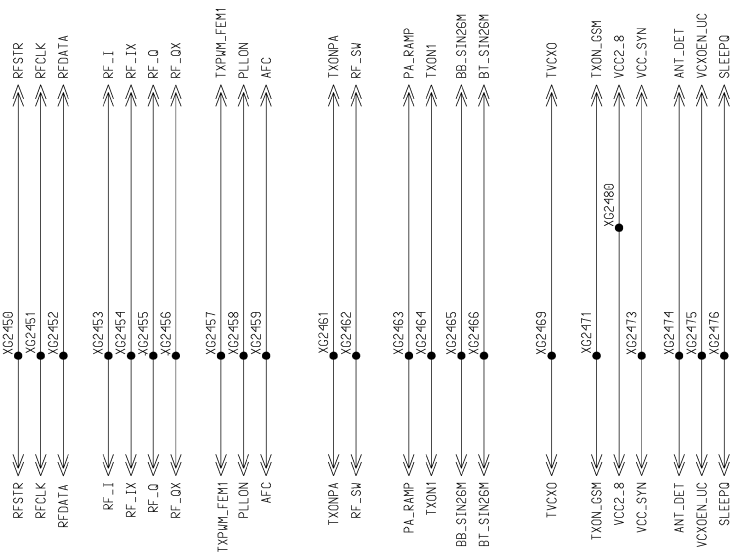

Electromechanic/RF
2253 - 2255

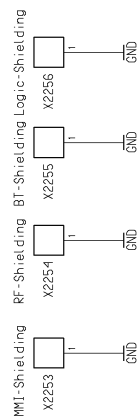

INTERFACE FOR LAYOUT
2800 - 2999

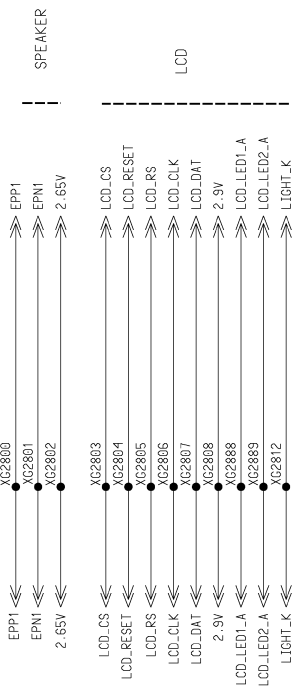

Bidirectional analogue RX/TX modulated signal

reference frequency connection

Power up Power amplifier

analogue power amplifier ramping signal
Switching-signal for PA-control IC

26 Mhz reference frequency

temperature sensor X-tal

VCC RF

DETECTION internal/external Antenna

SIDE-KEY

BATT-CON

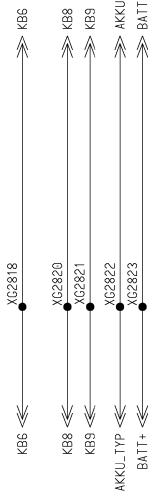

L55 Mainboard Marlin Bluetooth B2.1 CIRCUIT DIAGRAM		1:1	
Datum	21.03.2001	Upr	
Bearb		Upr	
Gepr.		Upr	
10	995	18.10.2002	LGE
9	993	12.09.2002	LGE
8	990	21.08.2002	LGE
7	976	30.07.2002	LGE
Zust	Wartung	Datum	Name
			Siemens AG
			8608
			Blatt/SHEET 4+
(Created by BOM number: 4500000112135_995)			

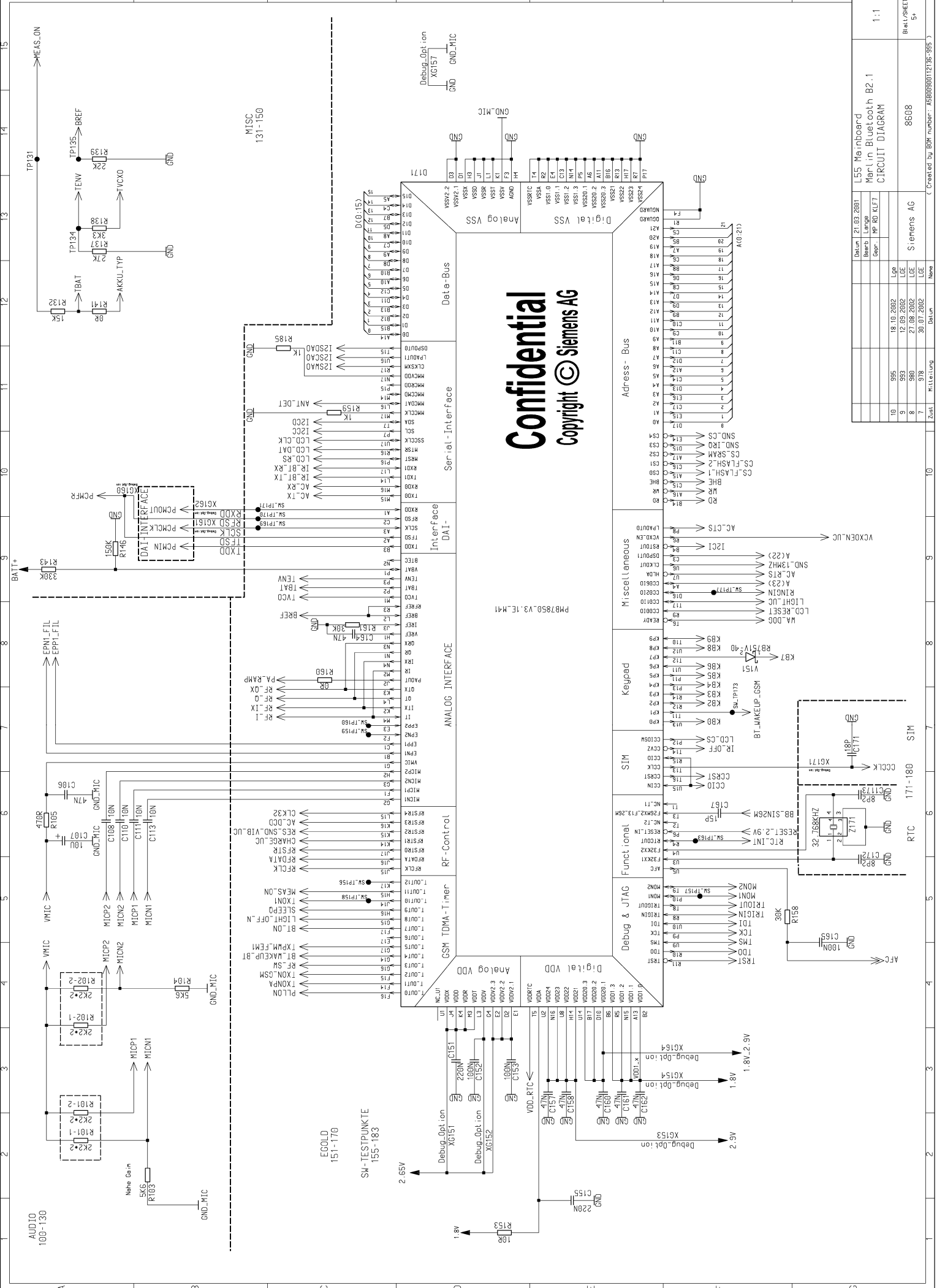

Confidential
Copyright © Siemens AG

Date		Description	
21.03.2001		Beib. Sprache	NP RD KLF7
18.10.2002	Lge		
12.09.2002	LCE		
21.08.2002	LCE		
30.01.2002	LCE		
Zust.		Name	
10	995	18.10.2002	Lge
9	993	12.09.2002	LCE
8	980	21.08.2002	LCE
7	918	30.01.2002	LCE
Wartung		Datum	
Siemens AG		8608	
		Blatt/SHEET 5*	
(Created by BOM number: A5000801136_995)			

Date		Description	
21.03.2001		Beib. Sprache	NP RD KLF7
18.10.2002	Lge		
12.09.2002	LCE		
21.08.2002	LCE		
30.01.2002	LCE		
Zust.		Name	
10	995	18.10.2002	Lge
9	993	12.09.2002	LCE
8	980	21.08.2002	LCE
7	918	30.01.2002	LCE
Wartung		Datum	
Siemens AG		8608	
		Blatt/SHEET 5*	
(Created by BOM number: A5000801136_995)			

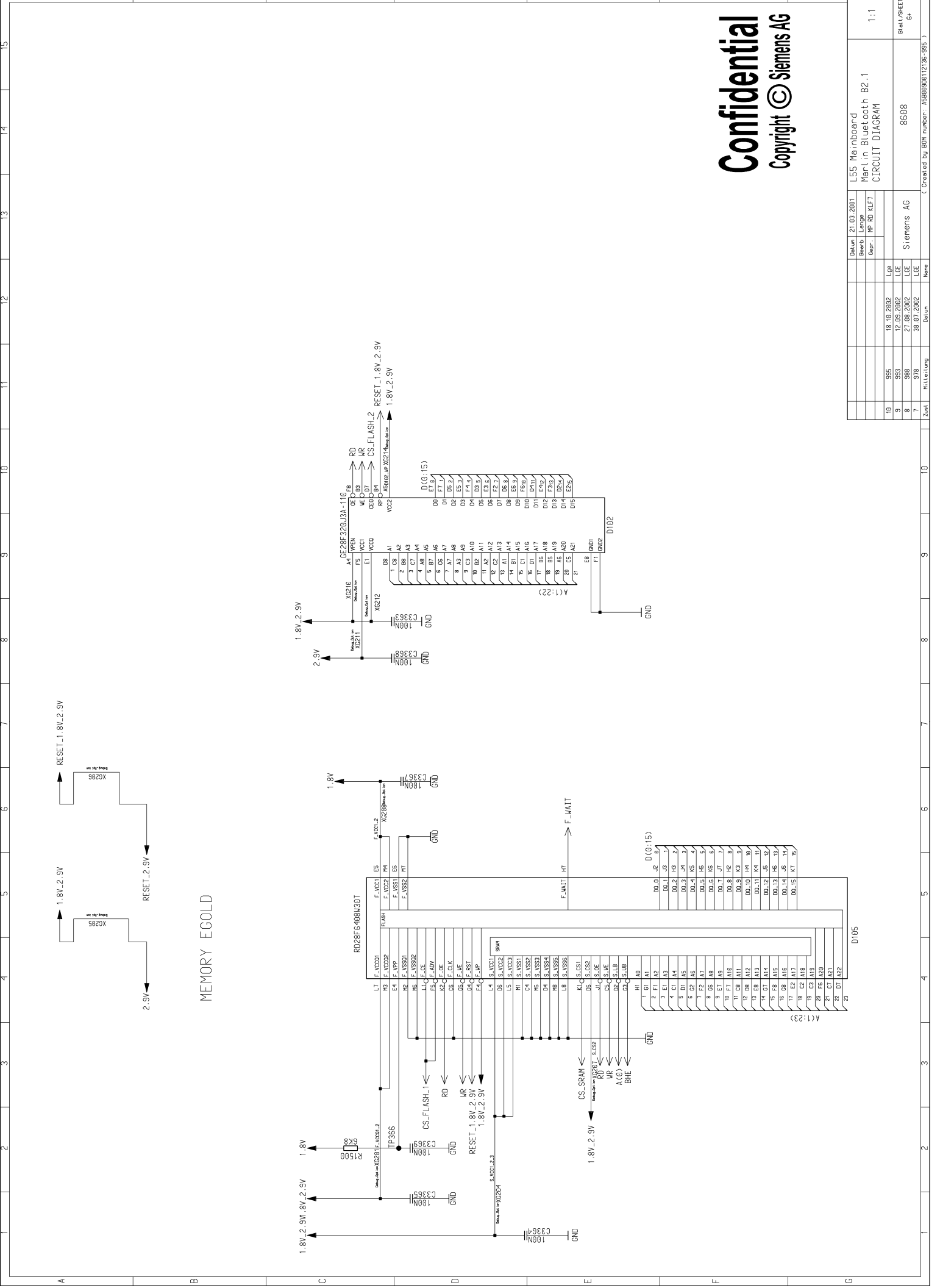

Confidential

Copyright © Siemens AG

L55 Mainboard		Marlin Bluetooth 82.1	
CIRCUIT DIAGRAM			
Date:		21.03.2001	
Bearb. Langbe		NP RD KLF7	
Gepr.:		:	
Lage:		:	
Lage:		18.10.2002	
Lage:		12.09.2002	
Lage:		21.08.2002	
Lage:		30.07.2002	
Name:		Siemens AG	
Zust:		Wartung	
Blatt/SHEET		8608	
Blatt/SHEET		6+	
(Created by BOM number: 45808080113135_995)			

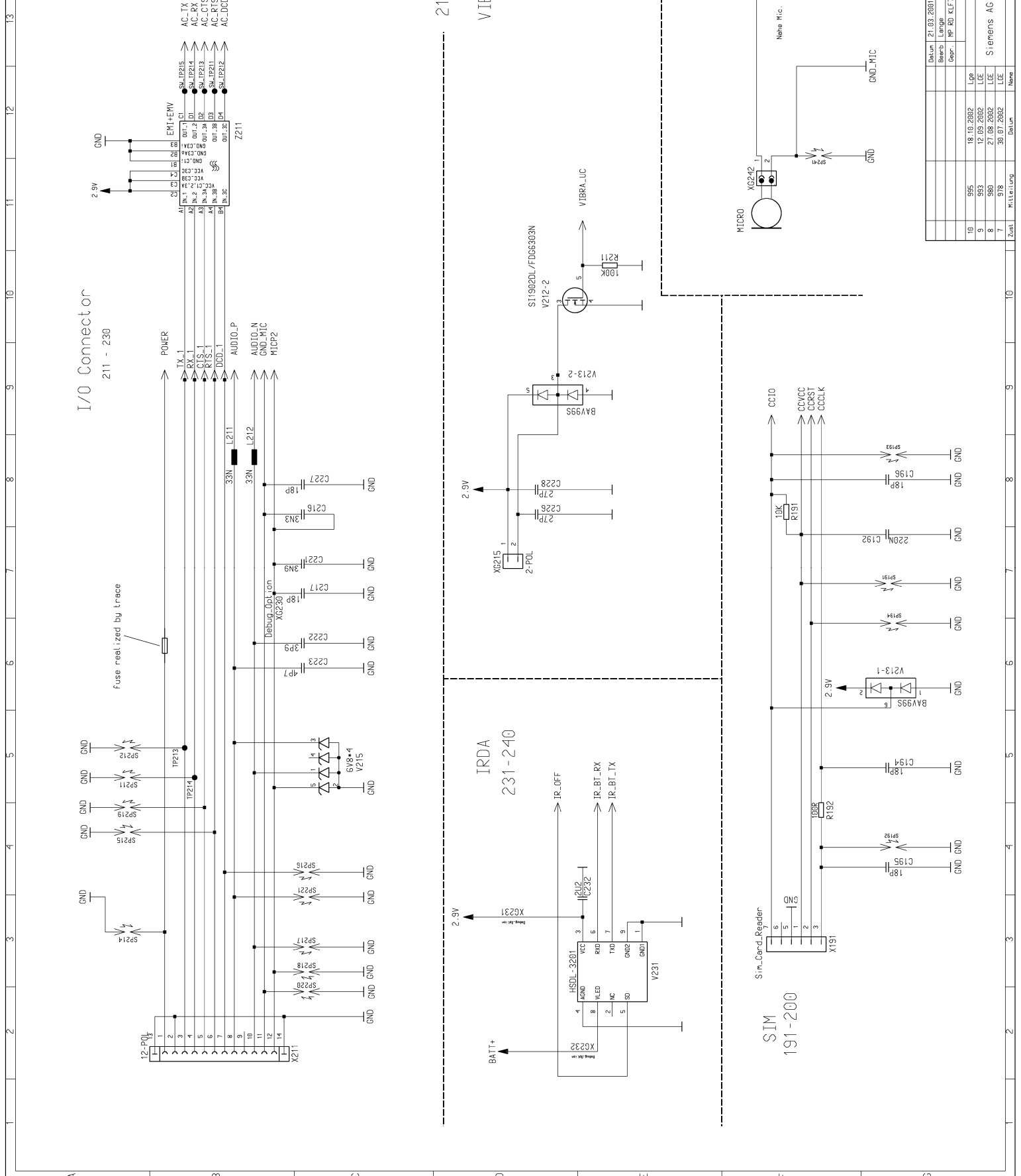

Item	Qty	Part No.	Description	Unit
10	995	18.10.2002	L55 Mainboard	
9	993	12.09.2002	Marlin Bluetooth B2.1	
8	980	21.08.2002	CIRCUIT DIAGRAM	
7	915	30.01.2002	Siemens AG	
6			8608	
5			(Created by BOM number: A5B0080012135_995)	

Item	Qty	Part No.	Description	Unit
10	995	18.10.2002	L55 Mainboard	
9	993	12.09.2002	Marlin Bluetooth B2.1	
8	980	21.08.2002	CIRCUIT DIAGRAM	
7	915	30.01.2002	Siemens AG	
6			8608	
5			(Created by BOM number: A5B0080012135_995)	

MMI CONNECTOR
271-280

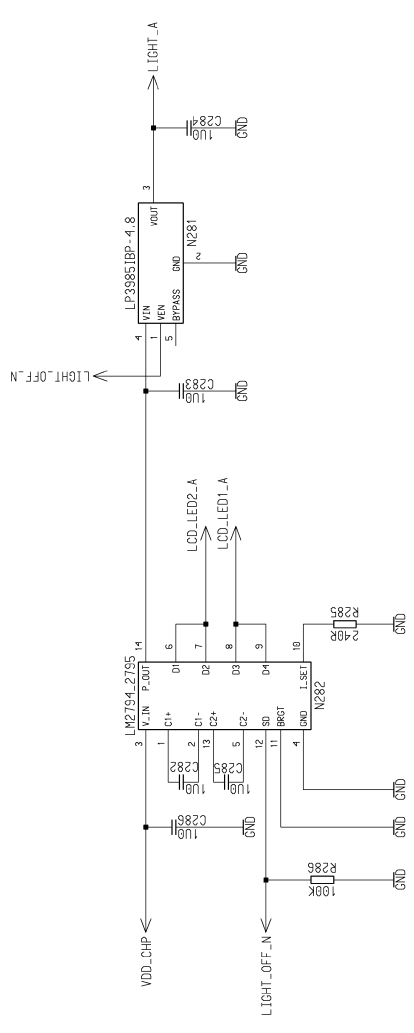
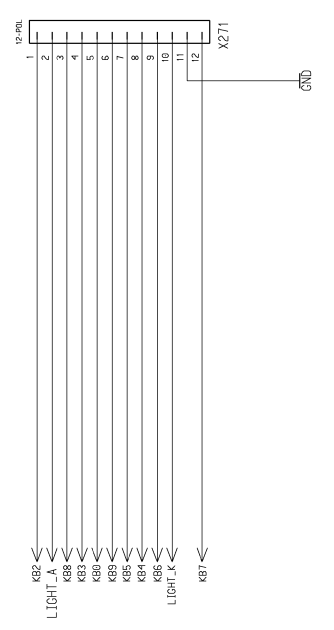

Backlight Voltage

Logic/Application_Processor
400-449

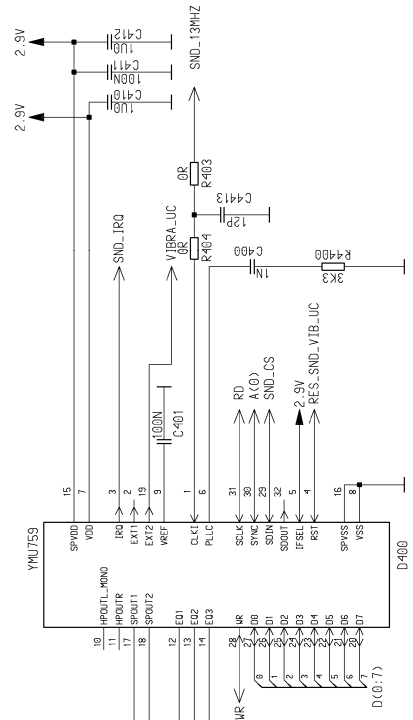

LIGHT_Circuit_MMI

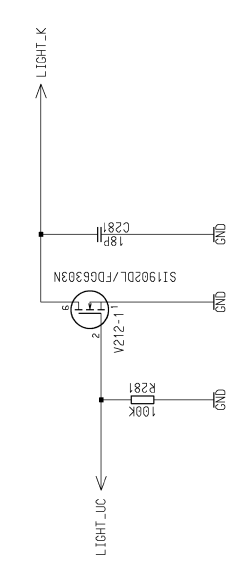

Date		L55 Mainboard	
Beib	Lang	Marlin Bluetooth B2.1	
Grp	Grp	CIRCUIT DIAGRAM	
10	995	Lge	
9	993	LCE	
8	990	LCE	
7	918	LCE	
Zust		Name	
Siemens AG		8608	
Wartung		(Created by BOM number: 45808080112136_995)	
1:1		Blatt/SHEET	
		8+	

POWER SUPPLY
361 - 399

Step_Down

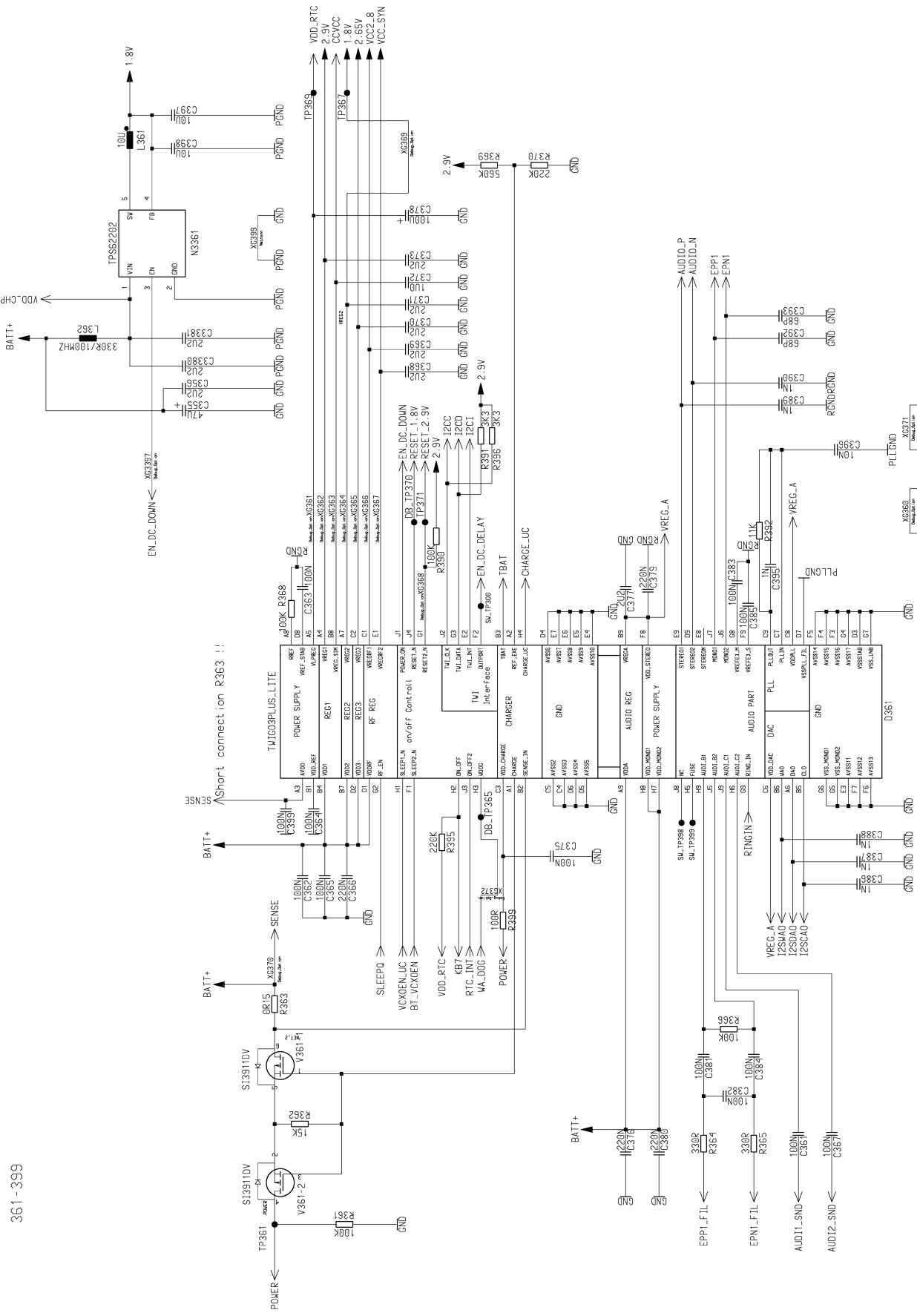

all rights reserved
Proprietary data, Company confidential.

Alle Rechte vorbehalten
Als Betriebsgeheimnis anvertraut

Item No.	Description	Quantity	Unit	Material
10	995		Lge	
9	993		LGE	
8	980		LGE	
7	918		LGE	
			Material	
Name: Siemens AG				
Date: 21.03.2001				
Drawing: L55 Meinboard				
Version: Marlin Bluetooth 82.1				
Part No: NP RD KLF7				
Scale: 1:1				

Confidential
Copyright © Siemens AG

(Created by BOM number: 456088001363_995)
Date: 21.03.2001

BLUETOOTH
450-499

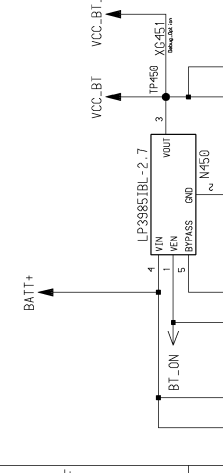
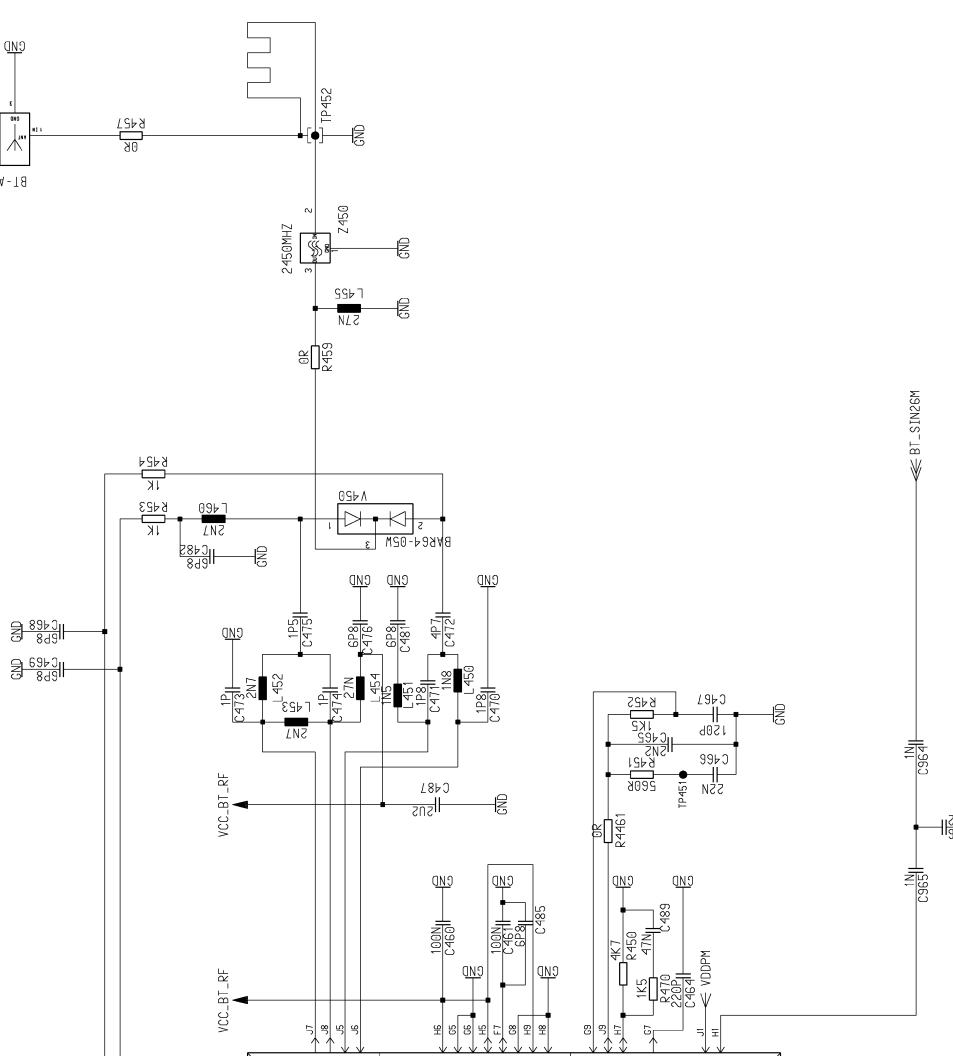
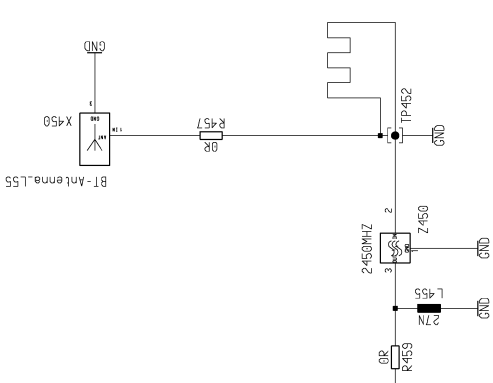

Bauteile sind am
EGOLD platziert

Confidential
Copyright © Siemens AG

Datum	21.03.2001
Beerb	
Langb	
VP	RD
KLF7	
Gepr.	
Siemens AG	
Lage	18.10.2002
LOE	9 993
LOE	12.09.2002
LOE	21.08.2002
LOE	990
LOE	30.01.2002
Name	8608
Zust	Wartung
Datum	

(Created by BOM number: 450009001121365_995)

RF/Antenna_Circuit
870 - 877

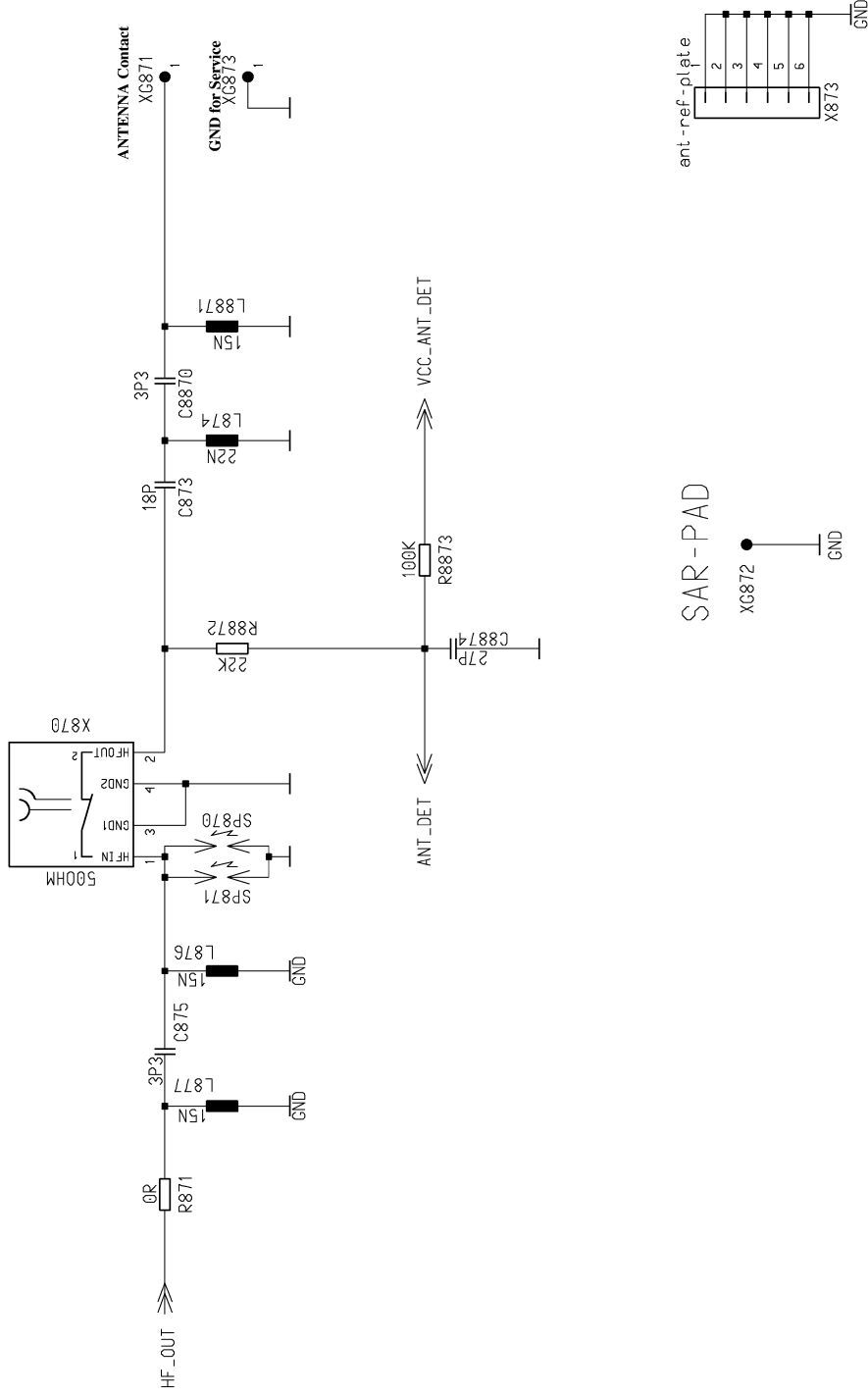

SAR - PAD

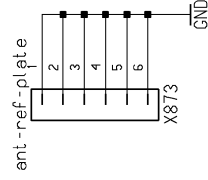

Confidential
Copyright © Siemens AG

Datum		21.03.2001		L55 Mainboard		1:1	
Bearb.		Länge		Marlin Bluetooth B2.1		Blatt/SHEET	
Gepr.		MP RD KLF7		CIRCUIT DIAGRAM		11-	
10		995		18.10.2002		LGE	
9		993		12.09.2002		LGE	
8		980		27.08.2002		LGE	
7		978		30.07.2002		LGE	
Zust.		Mitteilung		Name		Datei	
				Siemens AG		8608	
						(Created by BOM number: A5809500112136-995)	