

DATE	07.08.2002	K1 B2-4B Main Board
USER	Brandstov	Assembly Variant
APP'D		TOP HIERARCHY LEVEL
REF	P03 RD ML7	SCHEMATIC
Siemens AG	38878	sheet 1
VERS.	CHANGE NUMBER	DATE
1	5-520	13.05.2003
(Created by BOM number: A5B03901085257520)		

RF/Power_Control
920 - 949

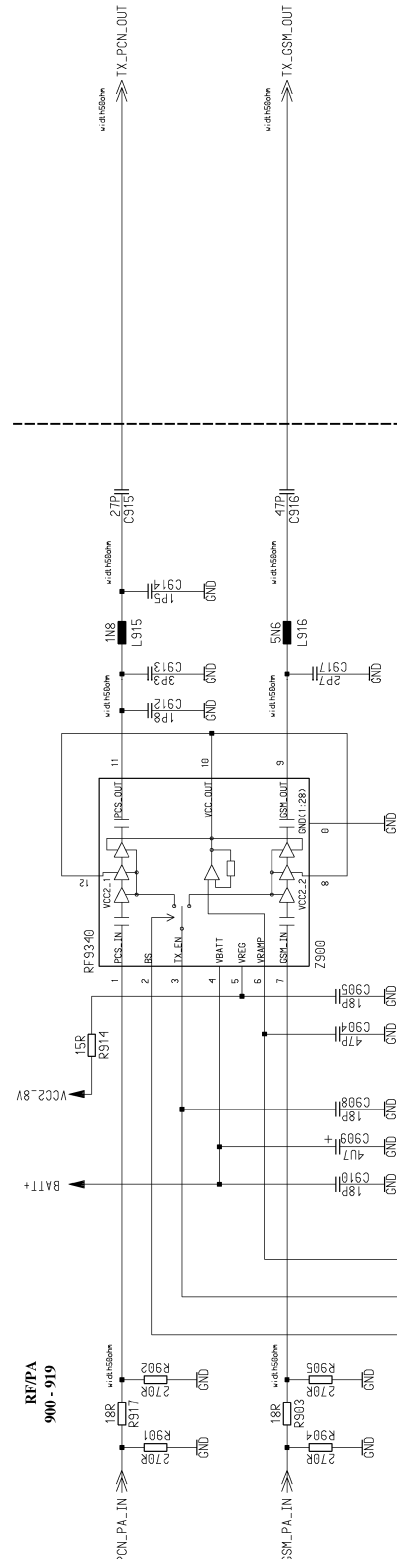

RF/Crystal_Oscillator
950 - 999

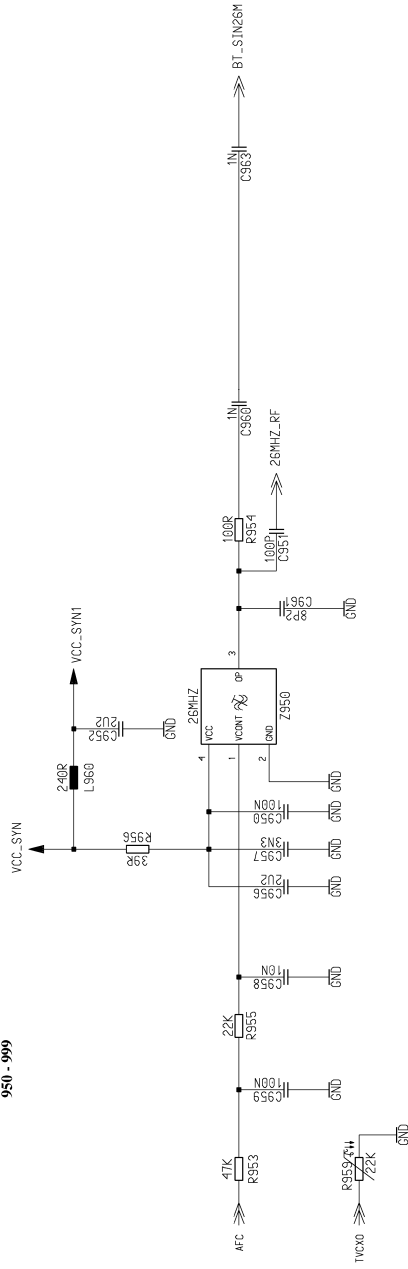

Proprietary data, Company confidential.
all rights reserved

Alle Rechte vorbehalten
SAP-Ident: 38878 / BOM / 000 / 01 Created/Changed: HOVALDT, ...

Confidential
Copyright © Siemens AG

DATE	07.08.2002	K1 B2-4B Main Board	sheet2
USER	Braunskov	Assemlu Variant	1:1
APP'D		TOP-HIERARCHY LEVEL	
		SCHEMATIC	
		Siemens AG	38878
VERS. CHANGE NUMBER	1	DATE	13.05.2003
	5-520		
(Created by BOM number: A5B0090010852-520)			

INTERFACE LOGIK/HF
3300-3399

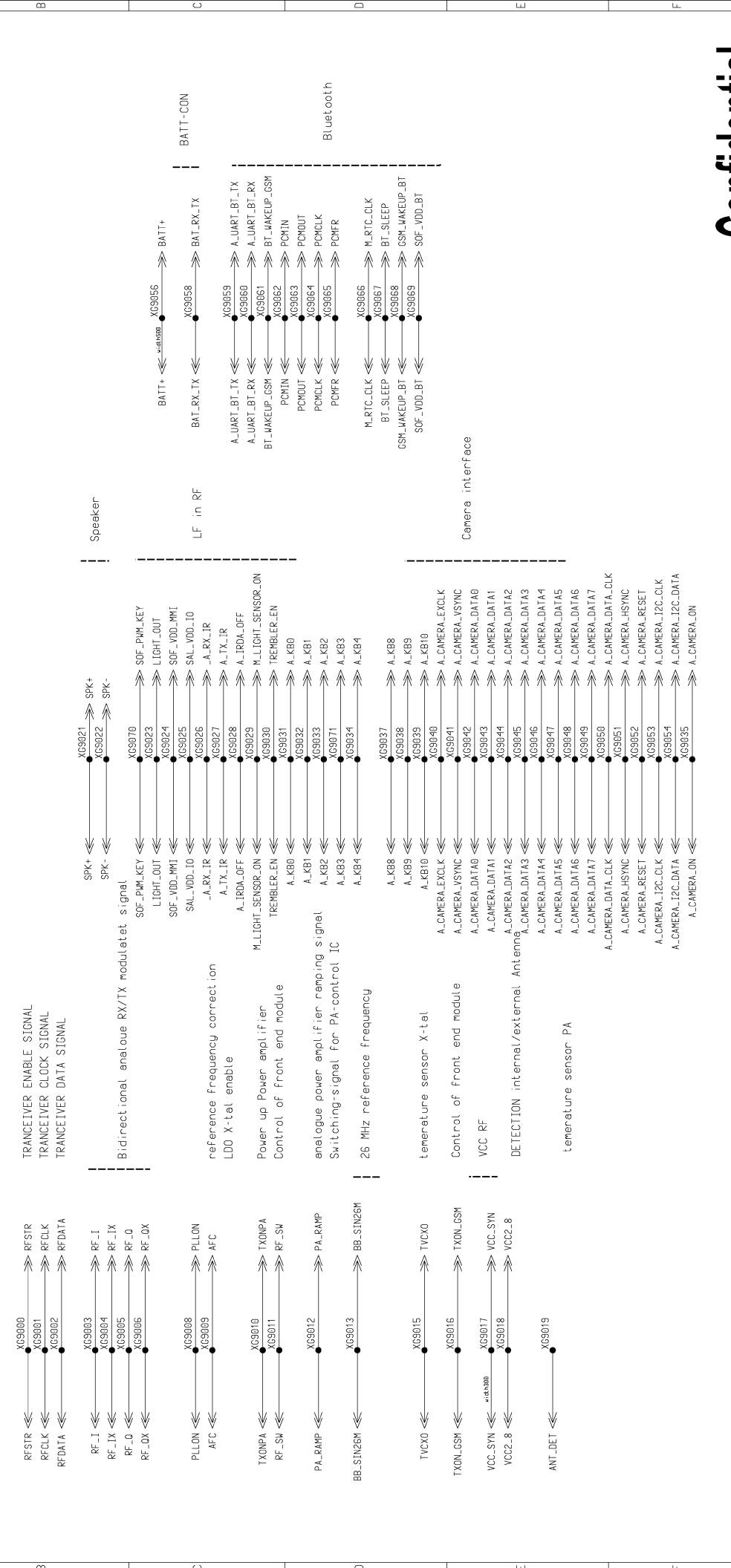

DATE	07.08.2002	K1 B2-4B Main Board
USER	Brenndisov	Assemblu Variant
APP'D		TOP HIERARCHY LEVEL
WIP	P03 RD AML7	SCHEMATIC
VERS.	1	Siemens AG
CHANGE NUMBER	5-420	38878
DATE	13.05.2003	
NAME		

(Created by BOM number: A5B003001085425700)

Confidential
Copyright © Siemens AG

MODEM MEMORY
2431-2450

MODEM DEBUG POINTS
2451-2499

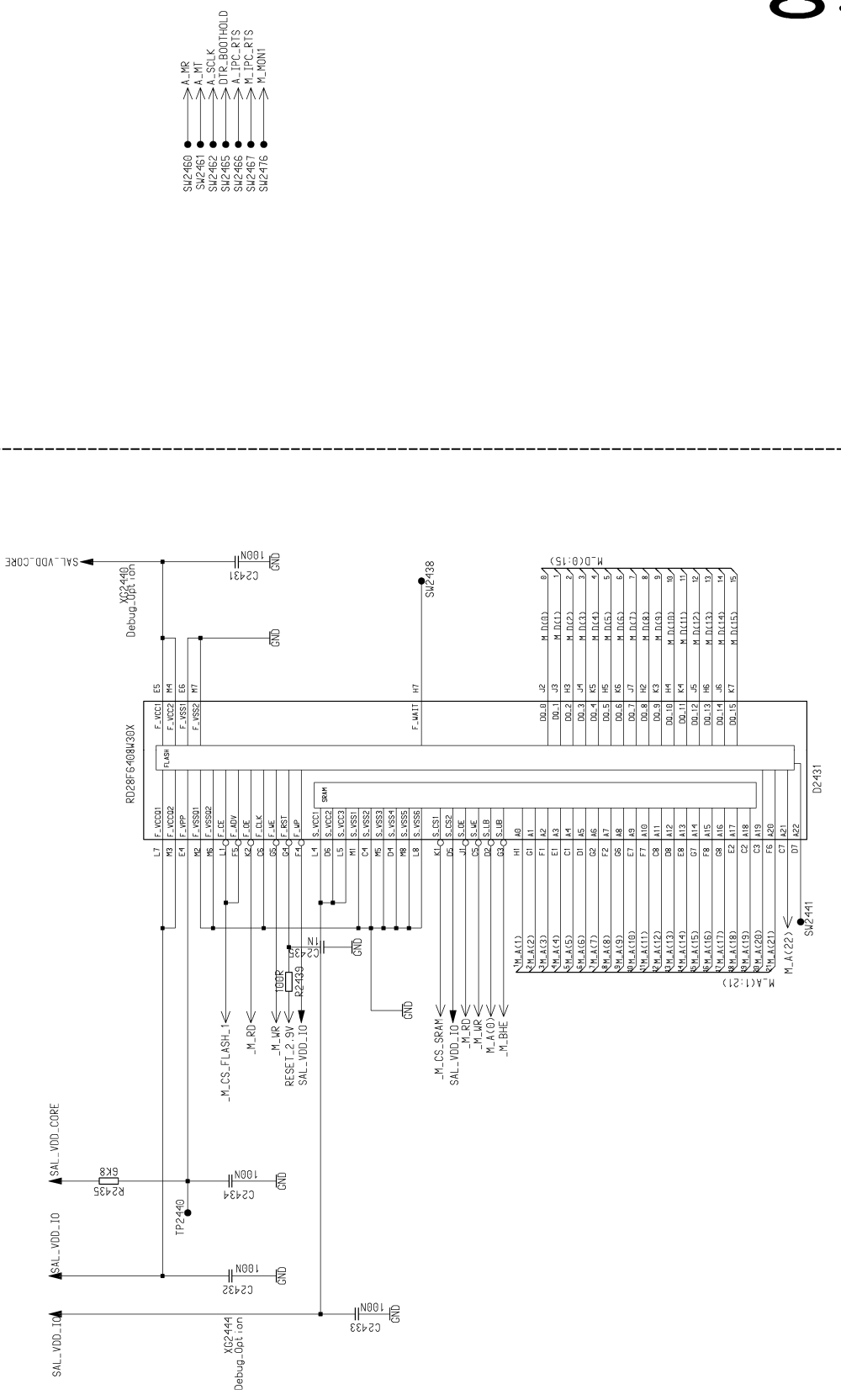

Confidential
Copyright © Siemens AG

DATE	07.08.2002	K1 B2-4B Main Board Assemlu Variant TOP HIERARCHY LEVEL SCHEMATIC	Siemens AG	38878	sheet6			
USER	Braenduskov							
APP'D								
VERS	1	CHANGE NUMBER	5-520	DATE	13.05.2003	ch	NAME	
(Created by BOM number: A5800900108562-5700)								

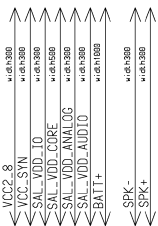

SALZBURG
BASEBAND_POWERSUPPLY
2800-2859

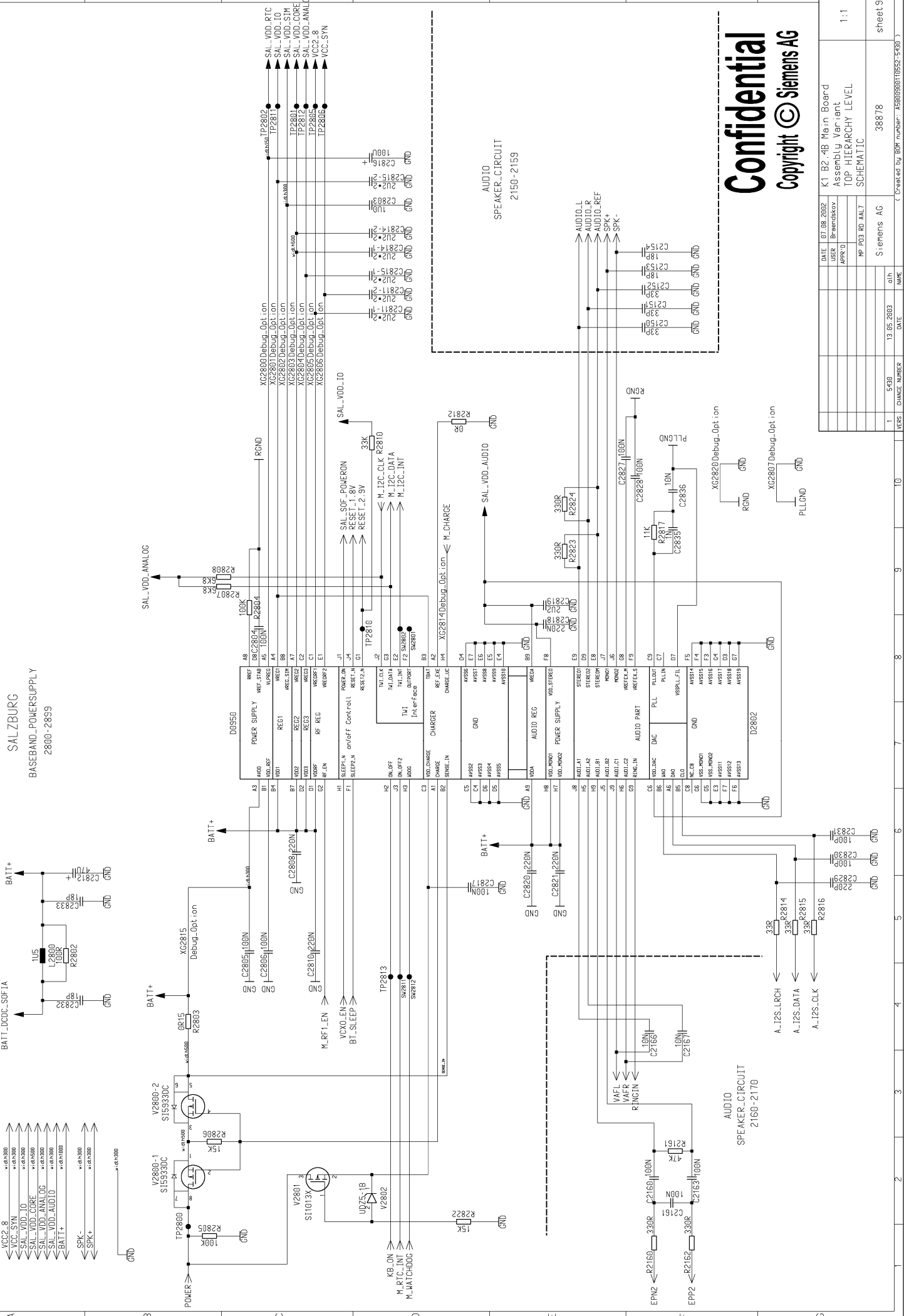

Alle Rechte vorbehalten
Proprietary data, Company confidential.
all rights reserved

Alle Rechte vorbehalten
Proprietary data, Company confidential.
all rights reserved

Confidential
Copyright © Siemens AG

DATE	USER	APP'D	WF	DESCRIPTION
07.08.2002	Brandensky			K1 B2-4B Main Board
				Assembly Variant
				TOP HIERARCHY LEVEL
				SCHEMATIC

VERS.	CHANGE NUMBER	DATE	BY	NAME
1	5-520	13.05.2003	gjh	Siemens AG

38878 sheet 9
(Created by BOM number: A5800901.0852.5700)

FM-RADIO
1100-1150

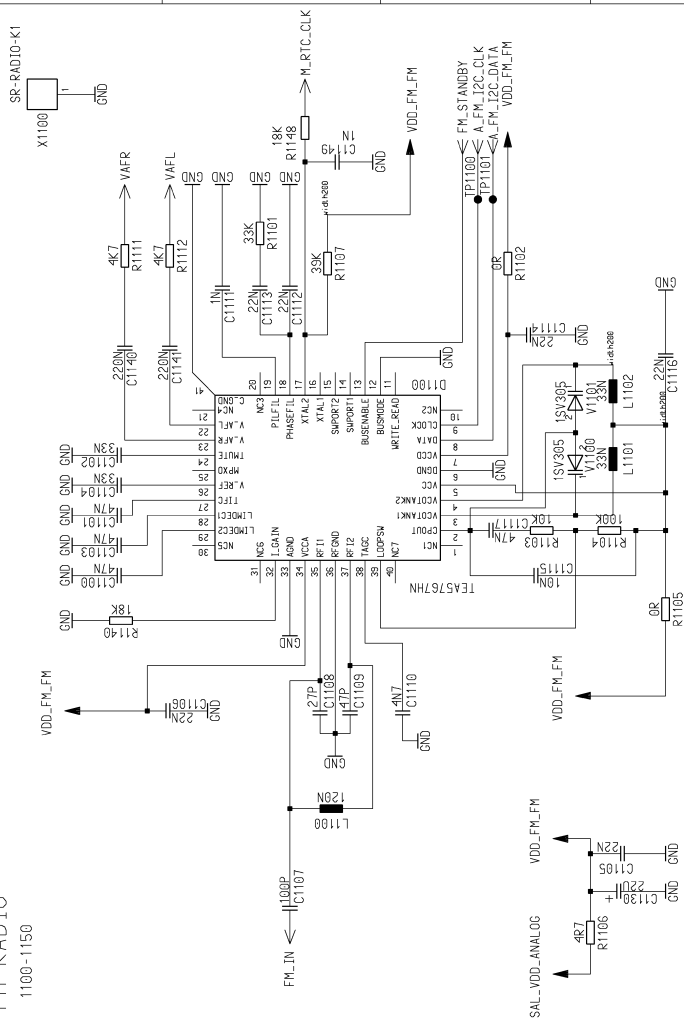

NAVI KEY
1151-1180

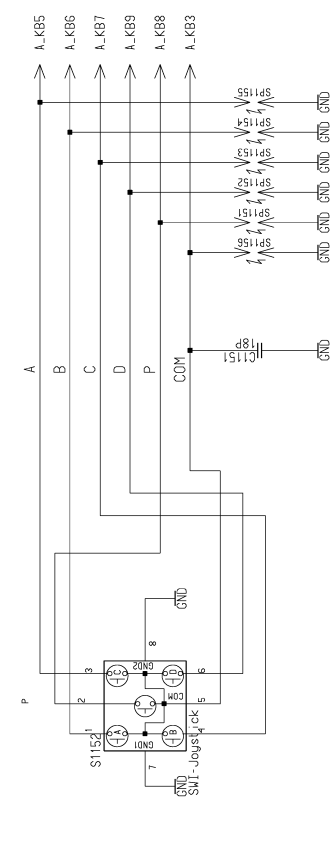

DETECT SWITCH
1181-1199

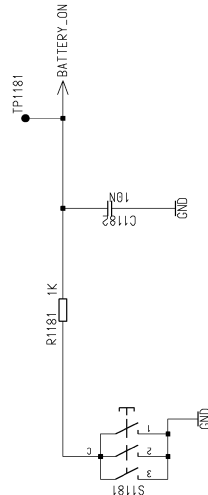

LIGHT SENSOR
1600-1650

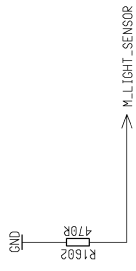

Confidential
Copyright © Siemens AG

DATE	07.08.2002	K1 B2-4B Main Board	sheet 10
USER	Brenndiskov	Assembly Variant	
APP'D		TOP HIERARCHY LEVEL	1:1
REF	P03 RD AML7	SCHEMATIC	
Siemens AG		38878	
VERS. / CHANGE NUMBER	1 / 5-03	DATE	13.05.2003
		auth. NAME	
		DATE	
(Created by BOM number: A580090108525300)			

RF/Antenna_Circuit
870 - 877

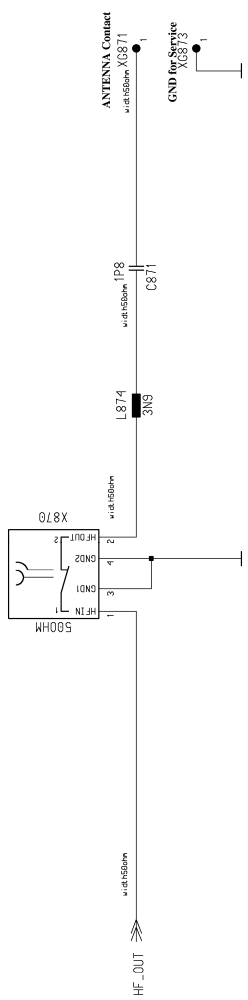

Confidential
Copyright © Siemens AG

DATE	07.08.2002	K1 B2-4B Main Board	Sheet 11
USER	Brenndskov	Assemblu Variant	
APP'D		TOP HIERARCHY LEVEL	
		SCHMATIC	
		RF_P03_RD_AML7	
		Siemens AG	38878
			(Created by BOM number: ASB00801085275200)
VERS.	CHANGE NUMBER	DATE	DATE
1	5-20	13.05.2003	01.05.2003

PROPRIETARY DATA, COMPANY CONFIDENTIAL
ALL RIGHTS RESERVED

ALS BETRIEBSGEBEHNIS ANVERTRAUT
ALLE RECHTE VORBEHALTEN

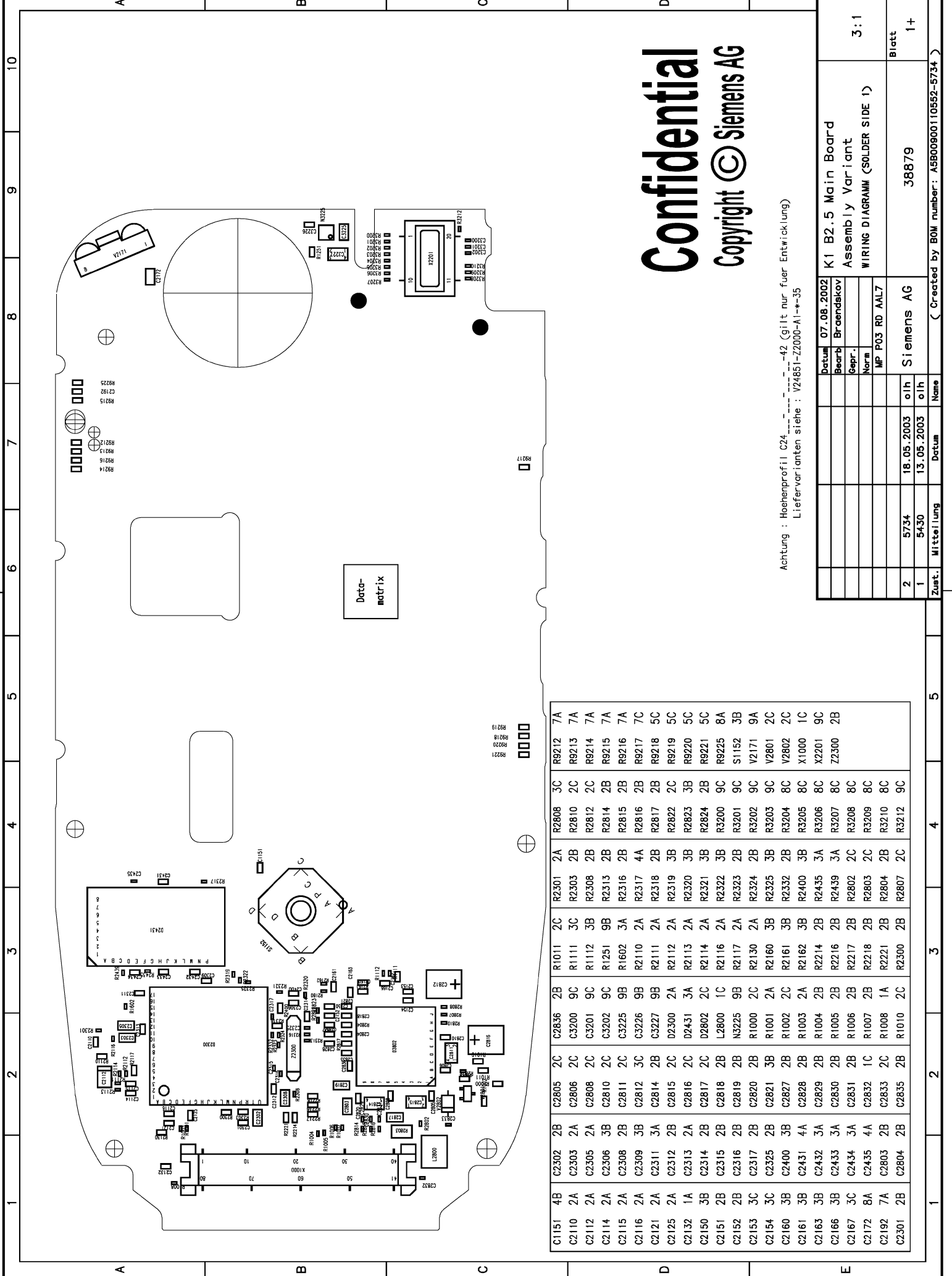

Confidential
 Copyright © Siemens AG

Achtung : Höhenprofil C24-----42 (gilt nur fuer Entwicklung)
 Liefervarianten siehe : V24851-Z2000-A1-4-35

Datum		07.08.2002	
Bearb.		Br-cendekov	
Gepr.			
Norm			
MP		P03 RD AAL7	
o/h		Siemens AG	
o/h		38879	
Blatt		1+	

(Created by BOM number: A5B00900110552-5734)

C1151	4B	C2302	2B	C2805	2C	C2836	2B	R1011	2C	R2301	2A	R2808	3C	R9212	7A
C1210	2A	C2303	2A	C2806	2C	C3200	9C	R1111	3C	R2303	2B	R2810	2C	R9213	7A
C1211	2A	C2305	2A	C2808	2C	C3201	9C	R1112	3B	R2308	2B	R2812	2C	R9214	7A
C1214	2A	C2306	3B	C2810	2C	C3202	9C	R1251	9B	R2313	2B	R2814	2B	R9215	7A
C1215	2A	C2308	2B	C2811	2C	C3225	9B	R1602	3A	R2316	2B	R2815	2B	R9216	7A
C1216	2A	C2309	3B	C2812	3C	C3226	9B	R2110	2A	R2317	4A	R2816	2B	R9217	7C
C1219	2A	C2311	3A	C2814	2B	C3227	9B	R2111	2A	R2318	2B	R2817	2B	R9218	5C
C1212	2A	C2312	2B	C2815	2C	D2300	2A	R2112	2A	R2319	3B	R2822	2C	R9219	5C
C1213	1A	C2313	2A	C2816	2C	D2431	3A	R2113	2A	R2320	3B	R2823	3B	R9220	5C
C1215	3B	C2314	2B	C2817	2C	D2802	2C	R2114	2A	R2321	3B	R2824	2B	R9221	5C
C1215	2B	C2315	2B	C2818	2B	L2800	1C	R2116	2A	R2322	3B	R3200	9C	R9225	8A
C1215	2B	C2316	2B	C2819	2B	N3225	9B	R2117	2A	R2323	2B	R3201	9C	S1152	3B
C1215	3C	C2317	2B	C2820	2B	R1000	2C	R2130	2A	R2324	2B	R3202	9C	V2171	9A
C1215	3C	C2325	2B	C2821	3B	R1001	2C	R2160	3B	R2325	3B	R3203	9C	V2801	2C
C1216	3B	C2400	3B	C2827	2B	R1002	2C	R2161	3B	R2332	2B	R3204	8C	V2802	2C
C1216	3B	C2431	4A	C2828	2B	R1003	2A	R2162	3B	R2400	3B	R3205	8C	X1000	1C
C1216	3B	C2432	3A	C2829	2B	R1004	2B	R2214	2B	R2435	3A	R3206	8C	X2201	9C
C1216	3B	C2433	3A	C2830	2B	R1005	2B	R2216	2B	R2439	3A	R3207	8C	Z2300	2B
C1217	3C	C2434	3A	C2831	2B	R1006	2B	R2217	2B	R2802	2C	R3208	8C		
C1217	8A	C2435	4A	C2832	1C	R1007	2B	R2218	2B	R2803	2C	R3209	8C		
C2192	7A	C2803	2B	C2833	2C	R1008	1A	R2221	2B	R2804	2B	R3210	8C		
C2301	2B	C2804	2B	C2835	2B	R1010	2C	R2300	2B	R2807	2C	R3212	9C		

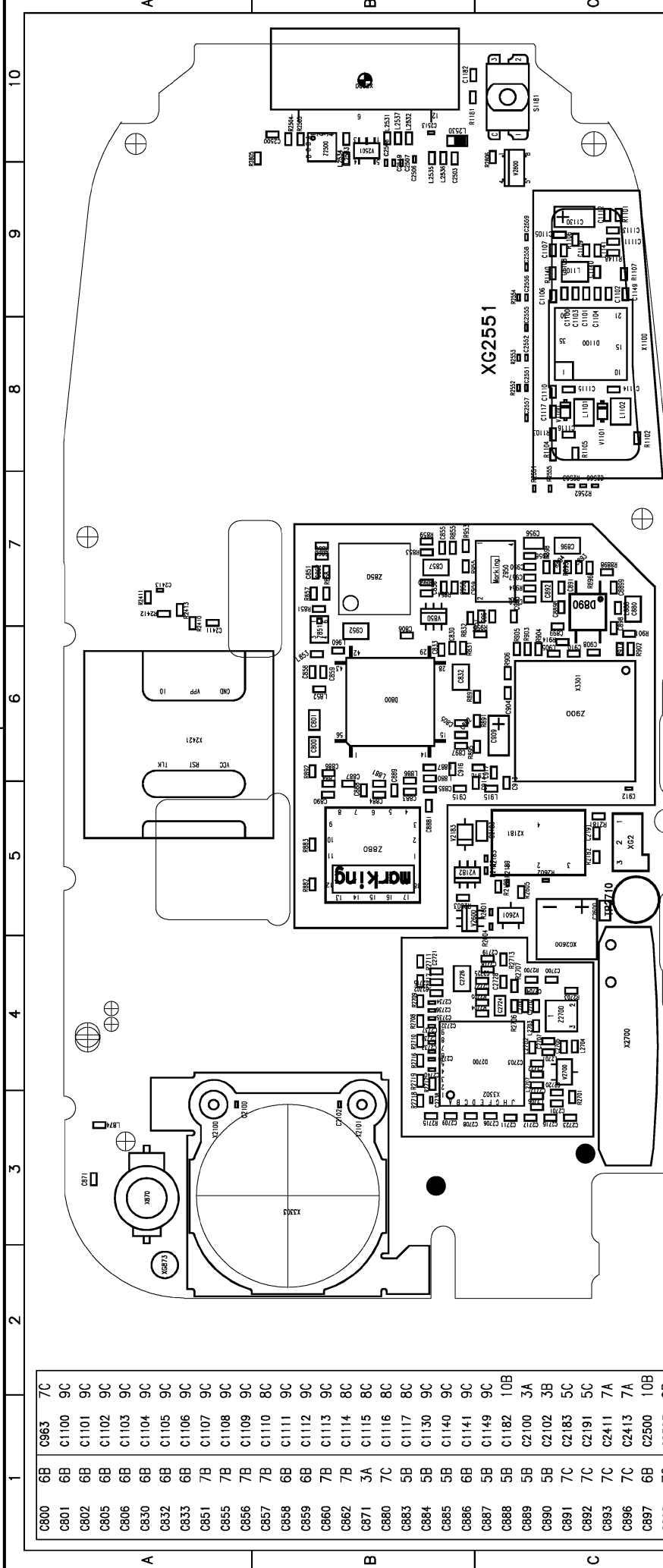

Confidential
Copyright © Siemens AG

Achtung : Höhenprofil C24-----42 (Gilt nur fuer Entwicklung)
Liefervarianten siehe : V24851-Z2000-A1-4-35

R2806	9C	X870	3A	Z880	5B
R8898	7C	X1100	9C	Z900	6C
S1181	10C	X2100	3A	Z950	7C
V850	7B	X2101	3B	Z2500	10B
V1100	8C	X2181	5C	Z2700	4C
V1101	8C	X2421	5A		
V2182	5B	X2500	10B		
V2183	5B	X2700	4C		
V2501	10B	X3301	5B		
V2600	5B	X3302	4C		
V2601	5C	X3303	4B		
V2700	4C	Z850	7B		
V2800	10C	Z851	7B		

R2806	9C	R1181	10B	R2603	5B
R8898	7C	R2181	5C	R2604	5C
S1181	10C	R2182	5C	R2605	5C
V850	7B	R2183	5C	R2700	4C
V1100	8C	R2187	5C	R2701	3C
V1101	8C	R2188	5C	R2703	4C
V2182	5B	R2189	5C	R2704	4C
V2183	5B	R2410	6A	R2705	4C
V2501	10B	R2411	7A	R2706	4C
V2600	5B	R2412	7A	R2707	4C
V2601	5C	R2413	7A	R2708	4B
V2700	4C	R2504	10B	R2709	4B
V2800	10C	R2505	10B	R2710	4B
		R2551	7C	R2711	4B
		R2552	8C	R2712	4B
		R2553	8C	R2713	4C
		R2554	9C	R2715	3B
		R2555	7C	R2716	4B
		R2556	7C	R2717	4B
		R2562	7C	R2718	3B
		R2563	7C	R2718	3B
		R2601	5C	R2719	4B
		R2602	5C	R2805	9B

C800	6B	C963	7C
C801	6B	C1100	9C
C802	6B	C1101	9C
C805	6B	C1102	9C
C806	6B	C1103	9C
C830	6B	C1104	9C
C832	6B	C1105	9C
C833	6B	C1106	9C
C851	7B	C1107	9C
C855	7B	C1108	9C
C856	7B	C1109	9C
C857	7B	C1110	8C
C858	6B	C1111	9C
C859	6B	C1112	9C
C860	7B	C1113	9C
C862	7B	C1114	8C
C871	3A	C1115	8C
C880	7C	C1116	8C
C883	5B	C1117	8C
C884	5B	C1130	9C
C885	5B	C1140	9C
C886	6B	C1141	9C
C887	5B	C1149	9C
C888	5B	C1182	10B
C889	5B	C2100	3A
C890	5B	C2102	3B
C891	7C	C2183	5C
C892	7C	C2191	5C
C893	7C	C2411	7A
C896	7C	C2413	7A
C897	6B	C2500	10B
C898	7C	C2503	9B
C899	6C	C2506	10B
C904	6C	C2507	9B
C905	6C	C2508	9B
C908	6C	C2513	10B
C909	6C	C2549	9B
C910	6C	C2551	8C
C912	5C	C2552	8C
C913	6C	C2555	8C
C914	6C	C2556	9C
C915	5B	C2557	8C
C916	6B	C2558	9C
C917	6C	C2559	9C
C950	7C	C2560	7C
C951	7C	C2600	5C
C952	6B	C2700	4C
C956	7C	C2701	3C
C957	7C	C2702	4B
C958	7B	C2703	4C
C959	7B	C2704	4C
C960	7C	C2705	4C
C961	7C	C2706	3C

Datum		07.08.2002	
Beerb.		Br-cendakov	
Gepr.			
Norm			
MP		P03 RD AAL7	
Blatt		3:1	
Name		Siemens AG	
Datum		18.05.2003	
Name		38879	
Datum		13.05.2003	
Name		Siemens AG	
Datum		18.05.2003	
Name		38879	
Datum		13.05.2003	
Name		Siemens AG	
Datum		18.05.2003	
Name		38879	
Datum		13.05.2003	
Name		Siemens AG	

Created by BOM number: A5800900110552-5734

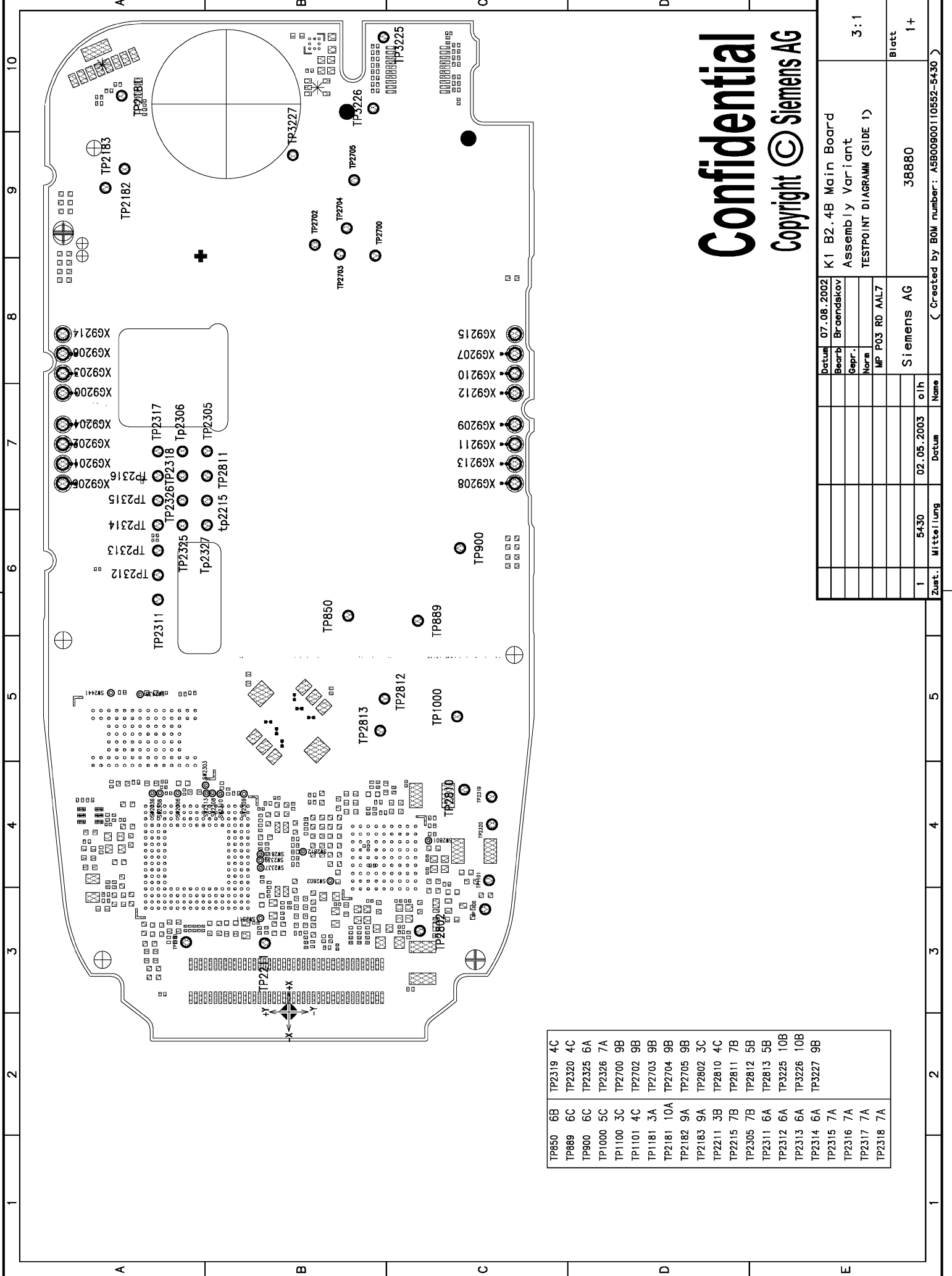

Confidential
 Copyright © Siemens AG

Datum	07.08.2002	K1 B2.4B Main Board
Bearb.	Br-cendekov	Assembly Variant
Gepr.		TESTPOINT DIAGRAM (SIDE 1)
Norm.		
IMP	P03 RD AAL7	
Siemens AG		38880
Blatt		1+

Zust. 1 5430 02.05.2003 o/h Name
 Datum
 Created by BOM number: A5B00900110552-5430

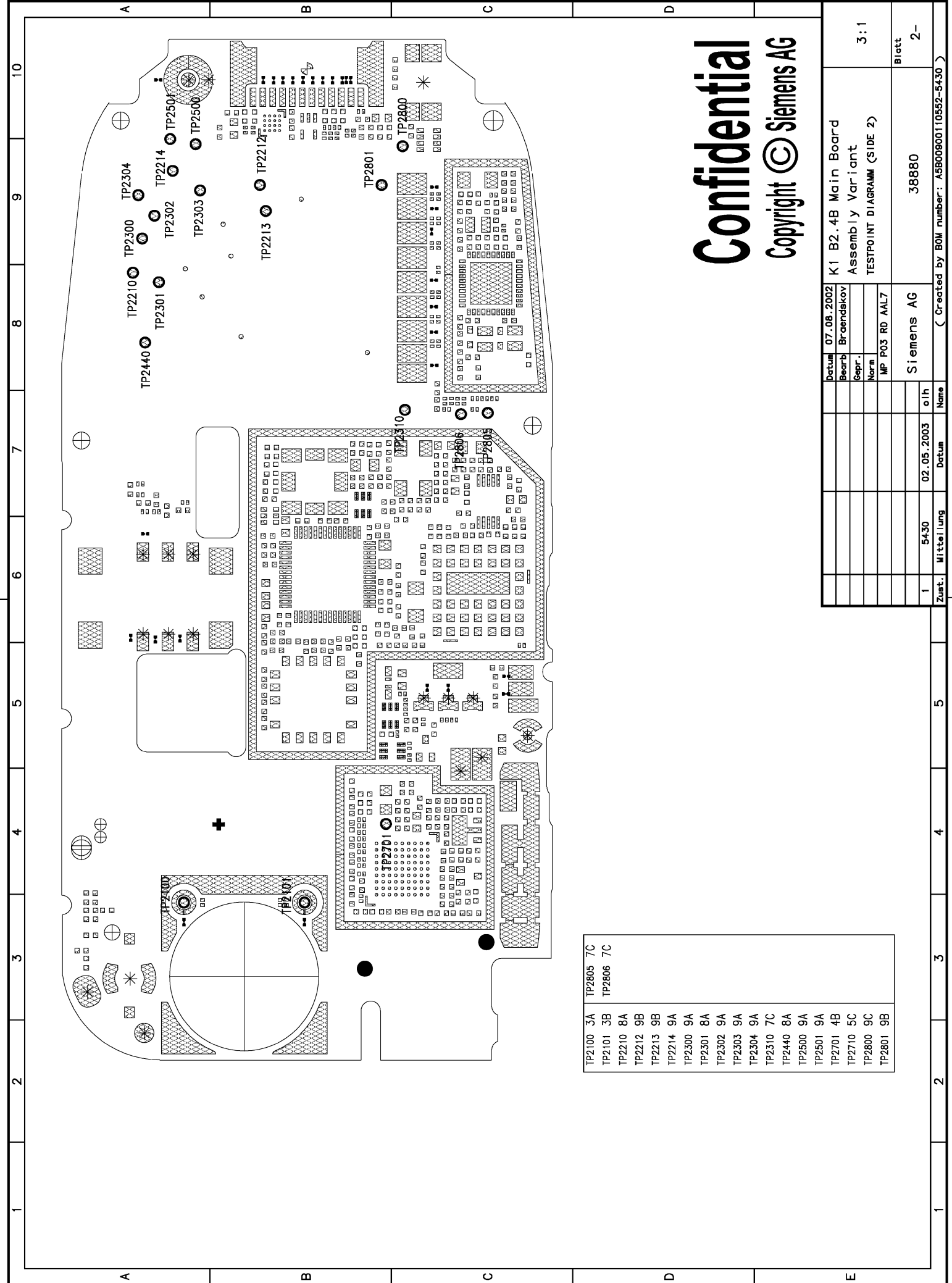

Confidential
 Copyright © Siemens AG

TP2100 3A	TP2805 7C
TP2101 3B	TP2806 7C
TP2210 8A	
TP2212 9B	
TP2213 9B	
TP2214 9A	
TP2300 9A	
TP2301 8A	
TP2302 9A	
TP2303 9A	
TP2304 9A	
TP2310 7C	
TP2440 8A	
TP2500 9A	
TP2501 9A	
TP2701 4B	
TP2710 5C	
TP2800 9C	
TP2801 9B	

Datum	07.08.2002	K1 B2.4B Main Board Assembly Variant TESTPOINT DIAGRAM (SIDE 2)	3:1		
Bearb.	Bracenskov				
Gepr.					
Norm.	MP P03 RD AAL7				
		Siemens AG	38880	Blatt	2-
Zust.	1	5430	Mitteilung	02.05.2003	o/h
					Name
(Created by BOM number: A5800900110552-5430)					

BOARD TO BOARD CONNECTOR
1100-1199

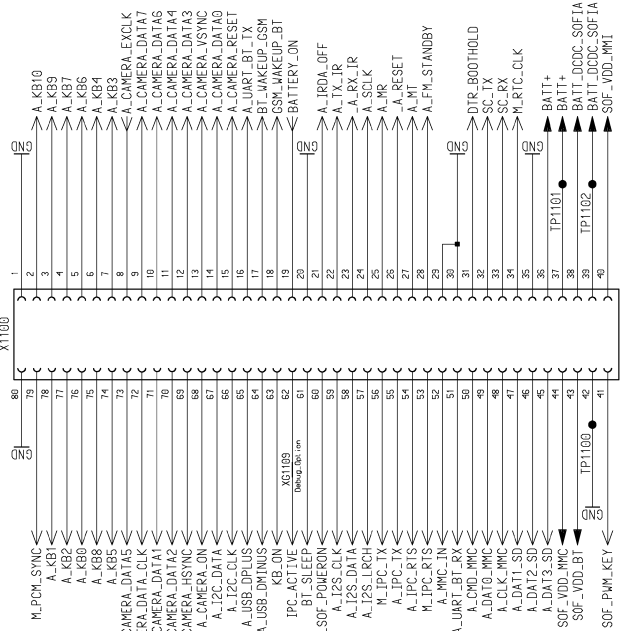

DISPLAY CONNECTOR
1000-1099

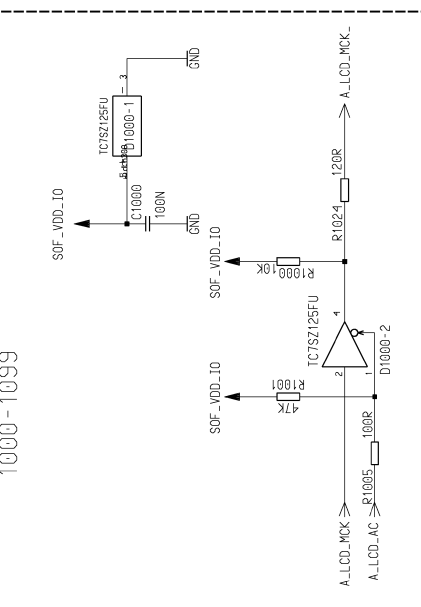

KEYS
1200-1299

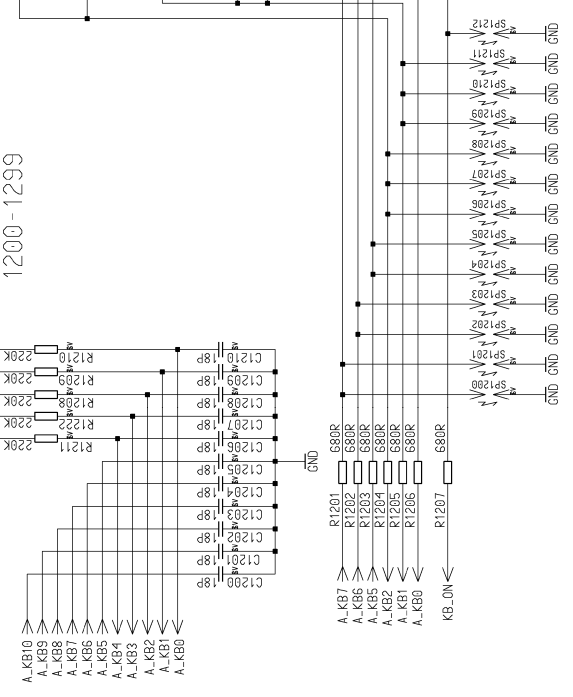

MAIN KEYS

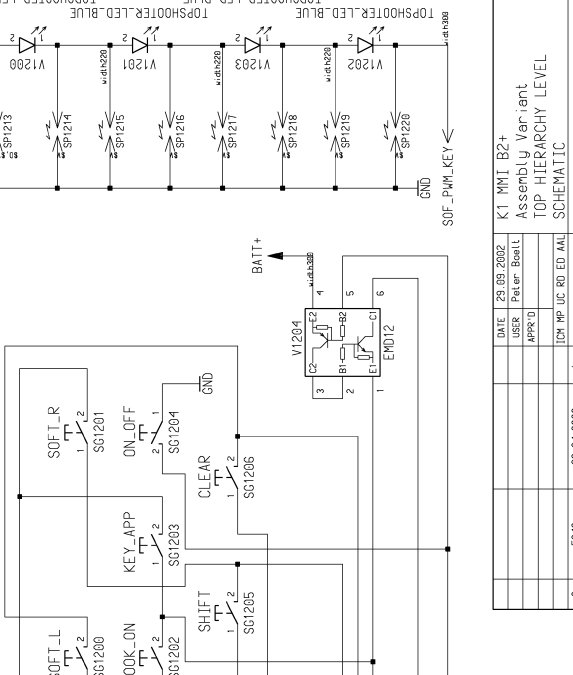

DATE	29.09.2002	K1 MMI B2+	1:1
USER	Peter Boel	Assembly Variant	TOP HIERARCHY LEVEL
APP'D			SCHEMATIC
ICM NP UC RD ED M/L			
VERS. CHANGE NUMBER		Siemens AG	32406
		pin	30.04.2003
		pin	05.03.2003
		pin	04.03.2003
		NAME	
		DATE	

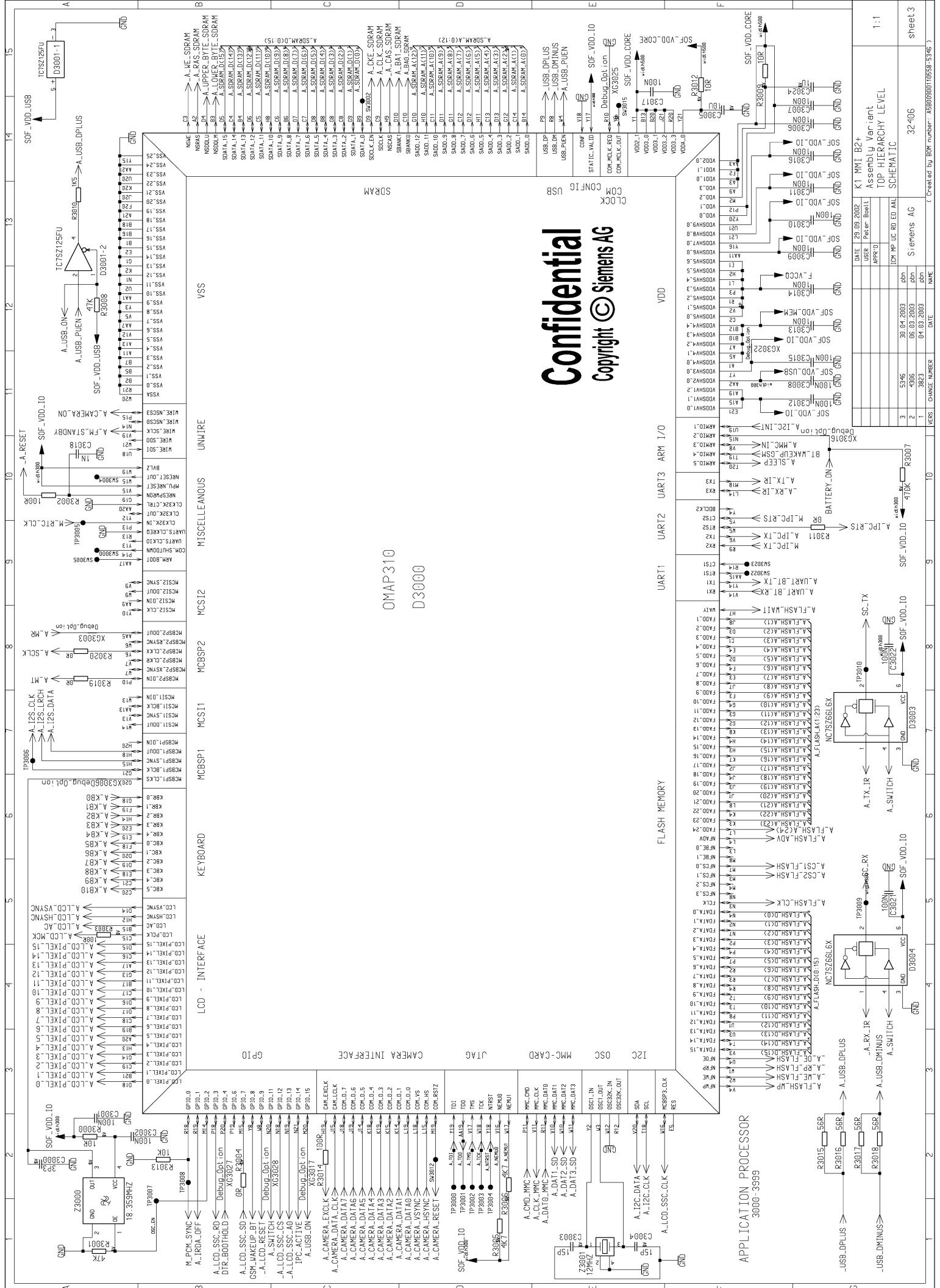

Confidential
Copyright © Siemens AG

DATE	USER	APP'D	ICM	HP	UC	RD	ED	MAIL	NAME
29.09.2002 <td>Peter Basell <td></td> <td></td> <td></td> <td></td> <td></td> <td></td> <td></td> <td></td> </td>	Peter Basell <td></td> <td></td> <td></td> <td></td> <td></td> <td></td> <td></td> <td></td>								
30.04.2003 <td>phn</td> <td></td> <td></td> <td></td> <td></td> <td></td> <td></td> <td></td> <td></td>	phn								
05.03.2003 <td>phn</td> <td></td> <td></td> <td></td> <td></td> <td></td> <td></td> <td></td> <td></td>	phn								
04.03.2003 <td>phn</td> <td></td> <td></td> <td></td> <td></td> <td></td> <td></td> <td></td> <td></td>	phn								

VERS.	CHANGE NUMBER	DATE	NAME
1	5346	04.03.2003	phn
2	5305	05.03.2003	phn
3	5346	04.03.2003	phn

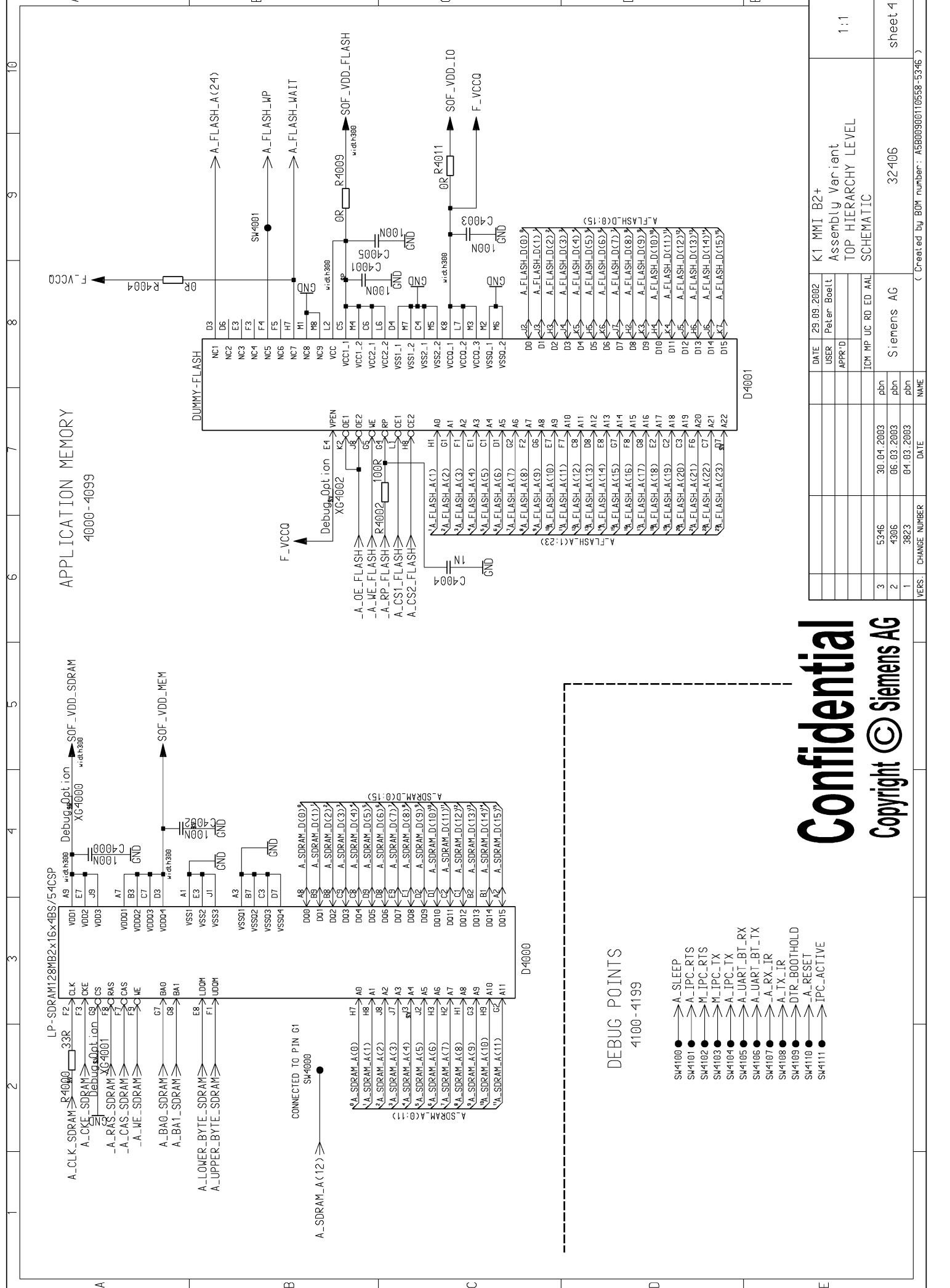

APPLICATION MEMORY
4000 - 4099

DEBUG POINTS
4100 - 4199

- SW4100 ● A_SLEEP
- SW4101 ● A_IPC_RTS
- SW4102 ● M_IPC_RTS
- SW4103 ● M_IPC_TX
- SW4104 ● A_IPC_TX
- SW4105 ● A_UART_BT_RX
- SW4106 ● A_UART_BT_TX
- SW4107 ● A_RX_IR
- SW4108 ● A_TX_IR
- SW4109 ● DTR_BOOTHOLD
- SW4110 ● A_RESET
- SW4111 ● IPC_ACTIVE

Confidential
Copyright © Siemens AG

Proprietary data, company confidential.
All rights reserved

Alle Betriebsgeheimnisse anvertraut
Alle Rechte vorbehalten

DATE	29.09.2002	USER	Peter Boelt
APPR'D		ICM MP UC RD ED AAL	
VERS.	CHANGE NUMBER	DATE	NAME
3	5346	30.04.2003	pbn
2	4306	06.03.2003	pbn
1	3823	04.03.2003	pbn
Siemens AG		K1 MMI BZ+	
TOP HIERARCHY LEVEL		Assembly Variant	
SCHEMATIC		1:1	
32406		Sheet 4	
(Created by BOM number : ASB009001T0558-5346)			

Confidential
 Copyright © Siemens AG

- R1200 6B
- R1201 6B
- R1202 5B
- R1203 5B
- R1204 5B
- R1205 5B
- R1207 5B
- R1212 6B
- V1200 7B
- V1201 6C
- V1202 7C
- V1203 6C

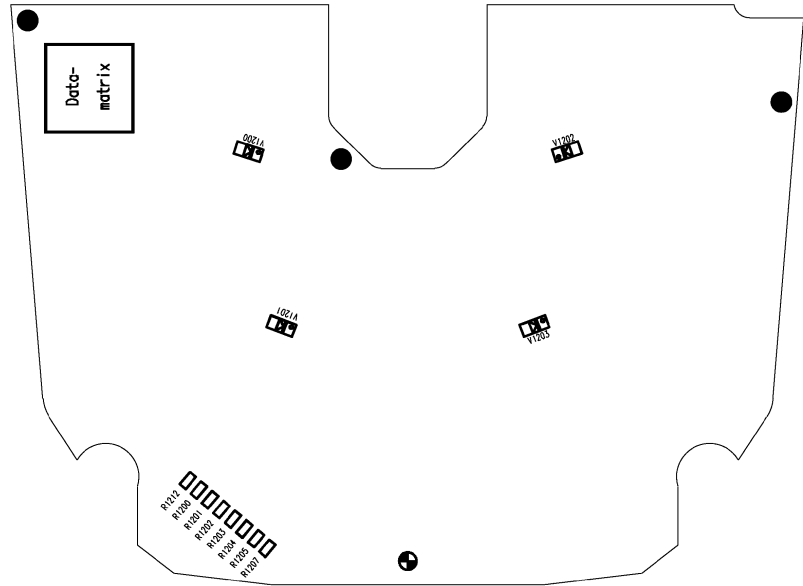

Achtung : Höhenprofil C24...42 (gilt nur fuer Entwicklung)
 Liefervarianten siehe : V24851-Z2000-A1-v-35

Datum	29.09.2002	K1 MMI B2+	Blatt	3:1
Bearb.	Peter Boelch	Assembly Variant		
Gepr.		WIRING DIAGRAM (SOLDER SIDE 1)		
Norm.				
	10W MP UC RD ED AAL			
	5346	05.05.2003	pbn	
	4306	06.03.2003	pbn	
	3823	05.03.2003	pbn	
Zust.	Mitteilung	Siemens AG	32407	1+
Name				

Created by BOM number: A5B00900110558-5346

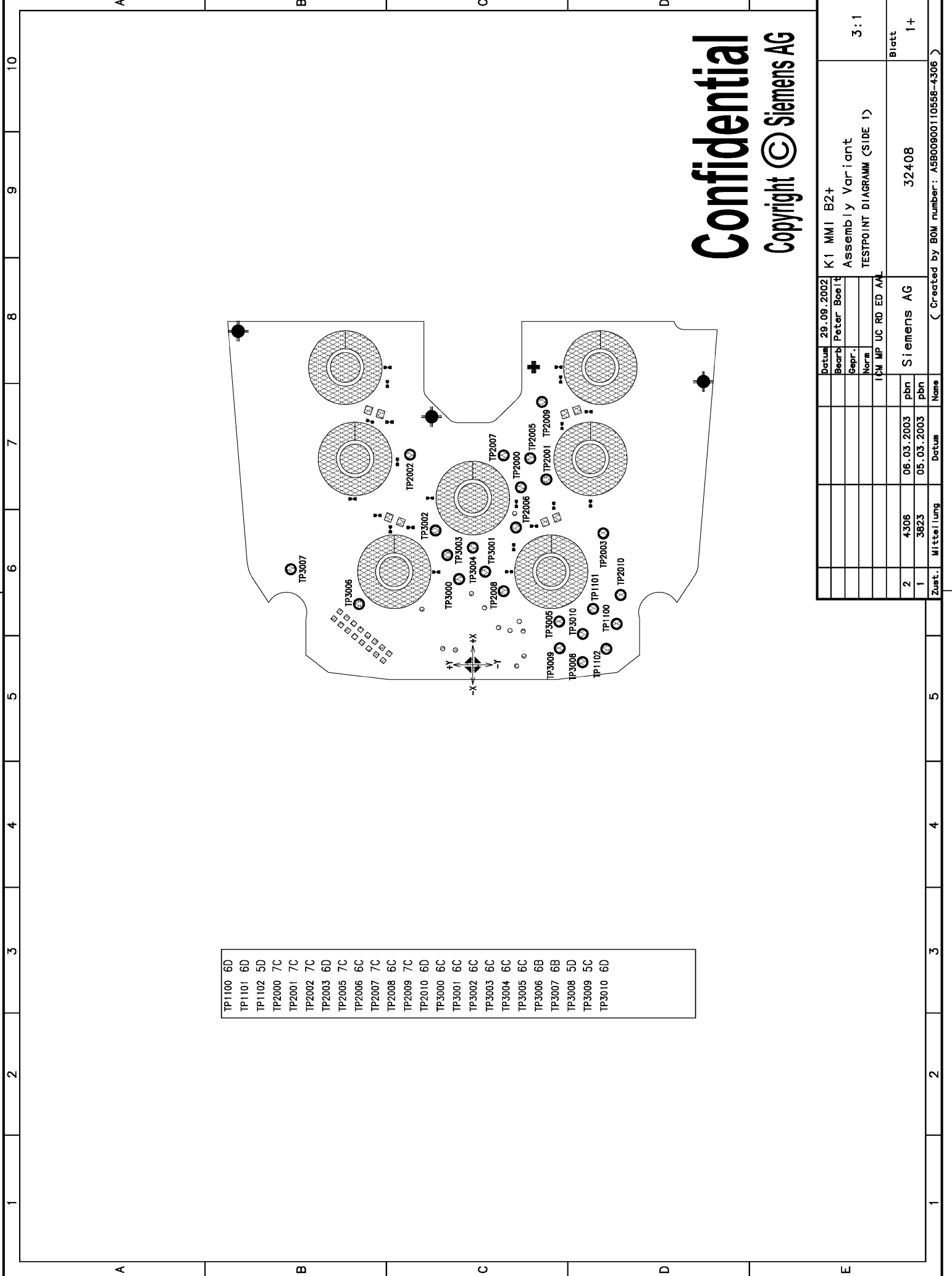

- | | |
|--------|----|
| TP1100 | 6D |
| TP1101 | 6D |
| TP1102 | 5D |
| TP2000 | 7C |
| TP2001 | 7C |
| TP2002 | 7C |
| TP2003 | 6D |
| TP2005 | 7C |
| TP2006 | 6C |
| TP2007 | 7C |
| TP2008 | 6C |
| TP2009 | 7C |
| TP2010 | 6D |
| TP3000 | 6C |
| TP3001 | 6C |
| TP3002 | 6C |
| TP3003 | 6C |
| TP3004 | 6C |
| TP3005 | 6C |
| TP3006 | 6B |
| TP3007 | 6B |
| TP3008 | 5D |
| TP3009 | 5C |
| TP3010 | 6D |

Confidential
 Copyright © Siemens AG

Datum	29.09.2002	K1 MMI B2+	Blatt	3:1
Bearb.	Peter Boelch	Assembly Variant		
Gepr.		TESTPOINT DIAGRAM (SIDE 1)		
Norm.				
	1/2W MP UC RD ED AAL			
		Siemens AG	32408	Blatt
				1+
				(Created by BOM number: A5B00900110558-4306)

Zust.	Mitteilung	Datum	Name
2	4306	06.03.2003	pbn
1	3823	05.03.2003	pbn

