



HITA-02886

SERVICE MANUAL

CAUTION:

Before servicing this chassis, it is important that the service technician read the "Safety Precaution" and "Product Safety Notices" in this service manual.

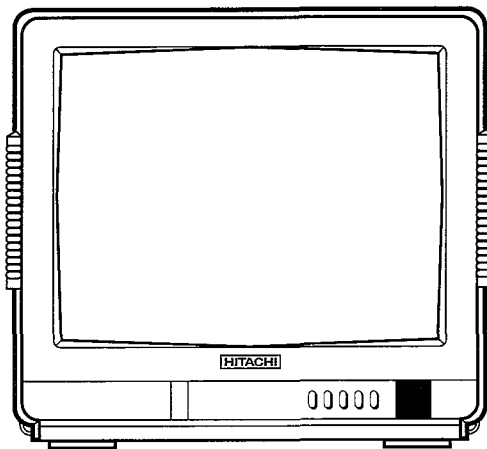

2111

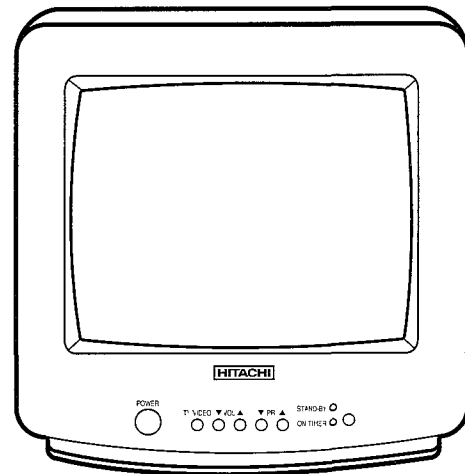

14 / 2011

TECHNICAL SPECIFICATIONS

TV standard	625 lines	Speaker	3W 8ohm, 7.7x7.7cm (14 inch) 3W 8ohm, 7.7x7.7cm (20 inch) 3W 8ohm, 11x5cm (21 inch)
Number of Program	100 Programs	Power consumption	Approx. 49W (14 inch) Approx. 59W (20 inch) Approx. 59W (21 inch)
Aerial input impedance	75 ohm unbalanced	Picture tube	V34cm Type(14 inch) V48cm Type(20 inch) V51cm Type(21 inch)
Focusing	Electro static	Dimensions;	Width ··· 366mm(14 inch), 490mm(20 inch), 530mm(21 inch) Height ··· 337mm(14 inch), 446mm(20 inch), 456mm(21 inch) Depth ··· 400mm(14 inch), 467mm(20 inch), 475mm(21 inch) Weight ··· 9.9kg(14 inch), 19.0kg(20 inch), 20.0kg(21 inch)
Mains voltage	220-240V~50Hz		
Fuses	F4AH 250V AC		
Programme selectors	Channel UP/DOWN buttons with 100 programme remote control		

■ SAFETY PRECAUTION and PRODUCT SAFETY NOTICE

SAFETY PRECAUTIONS

WARNING: The following precautions should be observed.

- 1 Do not install remove or handle the picture tube in any manner unless shatter proof goggles are worn. People not so equipped should be kept while picture tubes are handled. Keep the picture tube away from the body while handling.
2. When service is required, an isolation transformer should be inserted between the power line and the receiver before any service is performed on the chassis.
3. When replacing the chassis in the cabinet, ensure all the protective devices are put back in place, such as barriers, non-metallic knobs, adjustment or compartment covers or shields, isolation resistors/capacitors, etc.
- 4 When service is required, observe the original lead dressing. Extra precaution should be taken to assure correct lead dressing in the high voltage circuitry area. Particularly note the R G B. lead dressing. Ensure they are dressed well away from the horizontal scan and F.B.T circuitry.
5. Always use the manufacturer's replacement component. Always replace original spacers and maintain lead lengths. Especially critical components are indicated thus Δ on the parts list and should not be replaced by other makes. Furthermore, where a short circuit has occurred, replace these components that indicate evidence of overheating.
6. Before returning a serviced receiver to the customer, the service technician must thoroughly test the unit to be certain that it is completely safe to separate without danger of electrical shock, and be sure that no protective device built into the instrument by the manufacturer has become defective, or inadvertently damaged during servicing.
Therefore, the following checks are recommended for the continued protection of the customers and service technicians.

INSULATION

Insulation resistance should not be less than $10M\Omega$ at 500V DC between the mains poles and any accessible metal parts.

Also, no flashover or breakdown should occur during the dielectric strength test, applying 3kV AC or 4.25kV DC for two seconds between the main poles and accessible metal parts.

HIGH VOLTAGE

High voltage should always be kept at the rated value of the chassis and no higher. Operating at higher voltages may cause a failure of the picture tube or high voltage supply, and also, under certain circumstances could produce X-radiation levels moderately in excess of design levels. The high voltage must not, under any circumstances, exceed 27kV on the chassis.

X-RADIATION

TUBES: The primary source of X-radiation in this receiver is the picture tube. The tube utilised for the above mentioned function in this chassis is specially constructed to limit X-radiation.

For continued X-radiation protection, replace tube with the same type as the original HITACHI approved type.

PRODUCT SAFETY NOTICE

Many electrical and mechanical parts in HITACHI television receivers have special safety related characteristics. These characteristics are often not evident from visual inspection, nor can the protection afforded by them necessarily be obtained by using replacement components rated for higher voltage, wattage, etc. Replacement parts which have these special safety characteristics are identified by marking with a Δ on the schematics and the replacement parts list contained in this Service Manual.

The use of a substitute replacement component which does not have the same safety characteristics as the HITACHI recommended replacement one, shown in the parts list in this Service Manual, may create electrical shock, fire, X-radiation, or other hazards.

Product Safety is continuously under review, and new instructions are issued from time to time. For the latest information, always consult the current HITACHI Service Manual. A subscription to, or additional copies of HITACHI Service Manuals, may be obtained at a nominal charge from your HITACHI HOME ELECTRONICS (EUROPE) LTD office.

TUBE DISCHARGE

The line output stage can develop voltages in excess of 25kV; if the E.H.T. cap is required to be removed, discharge the anode to chassis via a high value resistor, prior to its removal from the tube.

■ BLOCK DIAGRAM

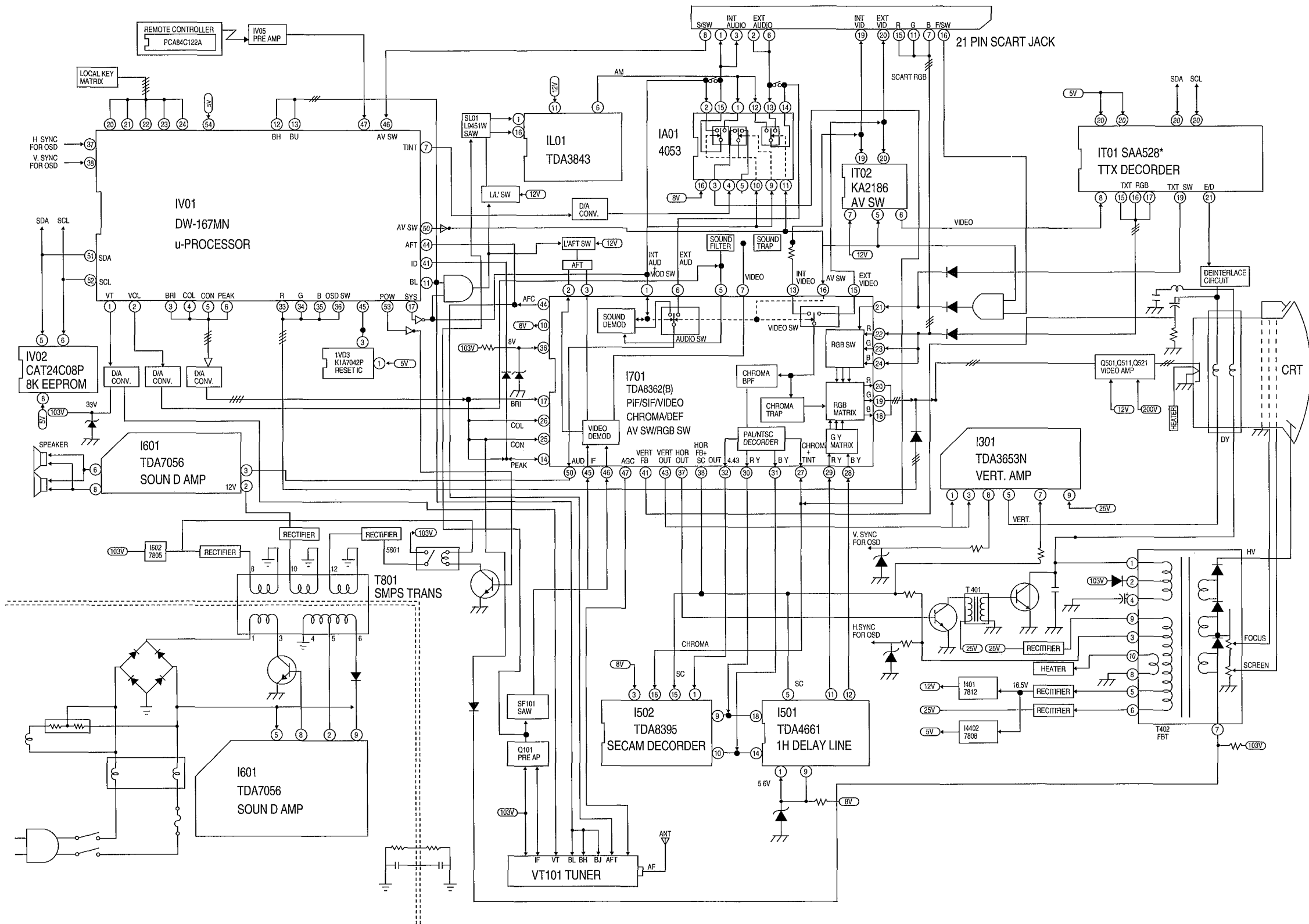

■ CIRCUIT DESCRIPTION

The function of the circuits used in this chassis are described in this chapter. For the component numbers used in this description, refer to the circuit diagram.

1. Small signal part with TDA8362

TDA8362 is realized in BIMOS process; the high frequency bipolar process is used for video processing and the MOS process is used for the digital part

TDA8362 combines all small signal functions, except the tuning, required for a colour television receiver.

Newly developed internal circuitry, such as integrated luminance delay line, chroma bandpass and trap, PLL sound demodulator and switches, reduce the number of required pins, external components and alignments

The reference tuned circuit is the only remaining alignment for this 52 pins (S-Dil) TV-processor.

The alignment-free SECAM add-on colour decoder circuit (TDA8395) can be used for applications with automatic standard switching

The internal functions of TDA8362 are

- Completely symmetrical AC-coupled vision I.F. amplifier and synchronous video demodulator
- A.G.C. detector suite for positive and negative modulation
- Tuner A.G.C., for PNP tuners
- Sample and hold A.F.C. circuit, with internal 90° phase shift
- Video pre-amplifier
- Inputs and switches for external audio, CVBS and S-VHS signals
- Sound I.F. limiter, automatic PLL demodulator and pre-amplifier with DC volume control
- Separate supply pin to start the horizontal circuitry from the mains rectifier
- Horizontal synchronization circuit with 2 control loops
- Vertical synchronization circuit with 2 control loops
- Vertical and horizontal drive circuits
- PAL/NTSC colour decoder, with automatic standard switching
- Chroma filters (bandpass and trap) with automatic system adaption
- Luminance delay line
- Peaking circuit in the luminance channel
- Mute function
- X-ray protection possibility

1.1 Vision I.F. amplifier, video demodulator and identification circuit.

- The vision I.F. amplifier consists of three AC-coupled differential stages. The gain control per stage is more than 20dB, which results in a total gain control of 64dB min. The amplifier is completely symmetrical, which has the advantage of a less critical application, the I.F. amplifier input can be coupled directly to the SAW-filter output. The input impedance is 2k Ω in parallel with 3pF. The input sensitivity for on-set of A.G.C. is 70 μ V (typ), for I.F. frequencies between 38.9MHz and 58.75MHz
- The reference carrier for the video demodulator is obtained via passive regeneration of the picture carrier. The reference tuned circuit is connected between pin 2 and 3. The IC can handle positive and negative modulated signals, the polarity of the demodulation can be switched at pin 1 (open=neg modulation, high=pos.modulation).
- A transmitter identification circuit operates independently of the synchronization circuit, to allow separate use of the front-end section and the display section of the TDA8362

1.2 A.G.C., tuner A.G.C. and A.F.C

- The A.G.C. detector operates at top-sync level for signals with negative modulation and at peak-white level for positive modulated signals. This A.G.C. detector is gated for negative modulated signals to reduce sensitivity to impulsive noise. The time constant capacitor (C117) is connected externally at pin 48.
- The tuner AGC take-over point can be set by adjusting the DC-voltage at pin 49, with a potentiometer of 10k Ω (VR101). The tuner A.G.C. (pin 47) is an open collector output stage with an output swing of 2mA min. the voltage swing, required by the tuner, can be obtained with an external resistor network, connected at pin 47. Pin 47 may rise 2V above the actual supply voltage level for min. gain.
- The A.F.C. circuit is driven by the same reference signal as the video demodulator. A sample and hold circuit avoids video break-through from the video demodulator to the A.F.C. voltage. The A.F.C. output voltage range is from 0 to 8V.

723

1.3. Sound circuit

- The sound carrier which is present at the video output pin 7 is fed via the sound bandpass to the sound input at pin 5. This has a double function; sound I.F. input (AC) and volume control (DC). The filtered intercarrier signal is fed to an amplifier/limiter circuit and demodulated by a PLL demodulator. This PLL demodulator tunes automatically to the incoming frequency, hence no alignment is required. The A.F. signal (pin 50) has an amplitude of 700mVrms at maximum volume control setting ($f = \pm 50\text{kHz}$). This volume control voltage is between 0 and 5V.

The de-emphasis capacitor (C601) is connected externally at pin 1. The noncontrolled audio signal (Peritelevision) is also obtained from pin 1 via an amplifier buffer stage (Q601 & Q602) and has an amplitude of 500mVrms ($\Delta f = \pm 50\text{kHz}$).

Audio input signal from an external source with an amplitude up to 350mVrms (+/-6dB) can be fed to pin 6. The audio switch is controlled via the pin 16, as described in Chapter 1.8. The volume control operates upon the external audio input signal, when TDA8362 is switched to the external mode.

1.4. Horizontal and vertical synchronization

- The incoming video signal, pin 15 for the video signal is fed to the synchronization separator circuit. Internally the black level and the top sync level are detected, next the synchronization pulses are amplified to a fixed level and sliced at 50% of that level. In this way a very good synchronization performance is obtained. The Separated synchronization pulses are fed to the first phase detector circuit and to the coincidence detector. The components which determine the loop gain of the first phase detector are connected at pin 40 (C404, C405 and R407). The coincidence detector is only used to detect whether the line oscillator is synchronized, not for transmitter identification. The second phase detector generates the pulses for the horizontal driver stage (pin 37). The loop filter capacitor (C403) is connected at pin 39. Horizontal shift can be obtained by a potentiometer and series resistor (VR401) connected at pin 39. The TDA8362 has separate start-up circuit for the horizontal oscillator (pin 36). In case this feature is used for starting the horizontal deflection the resistor connected at the base of the horizontal driver transistor must be connected to the start supply as well (pin 37 is an open collector). For applications which do not require a start-up function pin 36 must be connected to the main supply voltage (pin 10).
- The vertical drive pulses (pin 43) are generated by a divider circuit. The vertical ramp generator components are connected at pin 42. Capacitor C308 is charged via resistors (R311, VR302, R308) connected to +33V AC and DC feedback voltage from the vertical deflection stage must be connected at pin 41.

1.5. Integrated video filters

- The TDA8362 has an alignment-free internal chroma bandpass and trap circuit. These filters are realized by means of gyrator circuits and they are tuned by tracking to the frequency of the X-tal controlled oscillator.
- The luminance delay and the delay required for peaking are also realized by gyrator circuits. The peaking circuit can be controlled by μ -processor output voltage.

1.6. Colour decoder.

- The colour decoder contains an alignment-free X-tal oscillator, a killer circuit and the colour difference signals demodulators.

The decoder adapts automatically for PAL and NTSC signals. With the SECAM add-on decoder TDA8395 an alignment free multi-standard decoder with automatic selection can be built. This makes the application of the TDA8362 very flexible.

The following applications are possible.

- PAL-only

Connect one or two crystals to the IC (when just one crystal is used the other crystal pin has to be connected to ground via a resistor) and the hue control pin to the positive supply via a resistor of about 30k Ω . In this condition the decoder will not search for NTSC signals.

- PAL/NTSC

Connect one or two crystals to the IC and supply a control voltage between 0 and 5 V to the hue control pin. The decoder will identify PAL and NTSC signals at one or two frequencies. For the reception of the PAL-N and the PAL-M standard the two 3.5 MHz X-tals must be connected to pin 34. The switching between the X-tals must be made externally.

- PAL/SECAM

The chroma input signal for the SECAM decoder must be the same as that of the PAL decoder. This could be realized by means of an external switch which is connected in parallel with the internal video switch. In the TDA8362 we have a better alternative. When the NTSC option is not required the output signal of the switch can be obtained from the hue control input when this input is connected to the positive supply line via a suitable resistor.

- PAL/SECAM/NTSC

In this case the hue control must be active so that the previous application is not possible. Therefore an external video switch has to be added for this application.

In this chassis, PAL only and PAL/SECAM applications are possible. The burst phase detector locks the X-tal oscillator with the burst signal. Two gain modes provide an increased catching range when the PLL is un-locked and low ripple voltage and good noise immunity when the PLL is locked. The burst phase detector operates during the burst key period only, to prevent the PLL from being disturbed by the chroma signal.

The killer circuit switches-off the R-Y and B-Y demodulators at too low input signal condition (burst'amplitude). Proper hysteresis prevent constant on/off switching at a certain input level.

1.7. R.G.B output and input circuits

The colour difference signals are matrixed with the luminance signal to obtain the R, G, B output signals (pin 18, 19 and 20). Linear amplifiers have been chosen to interface external R, G, B signals (pin 22, 23 and 24) coming from the SCART connector. The contrast and brightness control operate both on internal and external signals. The data insertion pin 21 has a second detection level at 4V. Above this level the R, G, B outputs are blanked. In this way on-screen display (O.S D.) signals can be supplied directly to the inputs of the video output stages without any interaction to the RGB outputs of the colour decoder part of the TDA8362.

1.8. Switches for external audio, video

The audio video swtiches are controlled via the pin 16, according to the following table:

Level Pin 16	Int. Video	Ext. Video	Int Audio	Ext Audio
Dc<0.5V	ON	OFF	ON	OFF
DC>7.5V	OFF	ON	OFF	ON

2. Tuner

The board of this chassis is designed to use the tuner type VTSS-7SZ3, TEKE4-005B(120A), DT2-IV15P.

These have combined VHF/UHF (DT2-IV15P is UHF only), electronic tuning and band switching.

They can be used in applications with voltage synthesis tuning system.

The tuners fulfill all requirements concerning radiation, signal handling capacity and immunity for radiated interferences.

TYPE	STANDARD	PIF	BAND/CHANNEL
VTSS-7SZ3 (SHARP)	B/G	38.9MHz	VHF-1 : CH2-CH4 S1'-S3', S1-S2 VHF-3 : S3-S10 CH5-CH12 S11-S20 UHF : CH21-CH69
TEKE4-005B(120A) (J. ALPS)	B/G	38.9MHz	VHF-1 : CH2-CH4 S1'-S3', S1-S10 VHF-3 : CH5-CH12 S11-S20 S21-S41 (Hyper) UHF : CH21-CH69
DT2-IV15P	I	39.5MHz	UHF : CH21-CH69
TEKE4-	B/G-L L'	38.9MHz 34.5MHz	VHF-1 : CH2-CH4 S1'-S3', S1-S10 VHF-3 : CH5-CH12 S11-S20 S21-S41 (Hyper) UHF : CH21-CH69

3. SECAM decoder TDA8395

The TDA8395 is an alignment-free SECAM colour decoder and can be used in conjunction with the TDA8362. It includes the Cloche filter, demodulator and identification circuit. The TDA8395 application needs very few external components. The cloche filter is a gyrator-capacitor type filter. Its resonance frequency is controlled during the calibration period and offset during scan for the right resonance frequency. The required reference frequency for calibration must be connected at pin 1 and obtained from the TDA8362 (pin 32). The two (or three-) level sandcastle pulse has to be connected at pin 15 (TDA8362 pin 38) and used for generation of the blanking periods and provides clock information for the identification circuit.

The chroma signal at pin 16 connected to pin 27 of the TDA8362 is demodulated by a PLL demodulator, which uses the reference frequency and a bandgap reference to force the PLL to the desired demodulation characteristic.

Digital line identification is implemented to check the incoming signal for SECAM. If SECAM is detected and pin 1 will sink a current of 150µA. Together with the TDA8362 the voltage at this pin will become high (5.5V). In this case the colour difference signal outputs will be switched on. These outputs will be disconnected and high-ohmic when no SECAM is detected for two frame periods the demodulator will be initialized before trying again.

4. Baseband delay line TDA4665(U3661M)

The TDA4665 are integrated baseband delay lines of 64µs for colour television receivers. It can be connected to the TDA8362 and TDA8395 without the need of switches and alignments. The TDA4665 consists of two main blocks

- Two comb filters with a delay time of 64µsec
- Internal clock generation of 3MHz, line locked via the sandcastle pulse

TDA4665 operates according to the mode demanded by the colour transmission standard. In PAL mode it operates as a geometric adder to satisfy the requirements of PAL demodulation, in NTSC mode it reduces cross-colour interference (comb-filtering) and in SECAM mode the delay line repeats the colour difference signal on consecutive horizontal scan lines.

The colour difference signals are AC-coupled to pin 14 and 16 and clamped by the input stages. The internal clock drives the delay lines to obtain the required 64µsec. The clock pulses are derived from a 6MHz Current Controlled Oscillator which is line locked via a PLL with the sandcastle pulse, connected at pin 5. Sample and hold low pass filters suppress the clock signal. The delayed and un-delayed signal are added buffered and fed to the output pins 11 and 12.

5. Sound output stage TDA7056.

TDA7056 is a single A.F. output amplifier. It needs no peripheral components. It makes use of the Bridge-Tied-Load (BTL) principle. It has, at the same output voltage, a higher output power compared to a conventional single ended output stage. The TDA7056 delivers an output power of 1W into a loudspeaker load of 8Ω with 6V supply voltage and 3W into a 16Ω loudspeaker with 11V supply, without the need of an external heatsink. The gain is internally fixed at 40dB.

Special attention has been given to switch-on/off click suppression, and it has a good overall stability. The IC is short-circuit proof at all input conditions. Pin 50 of TDA8362 is AC coupled to the input pin 3 of TDA7056 via a resistor divider (R620 and R621) to adapt the voltage levels. The proper de-emphasis is obtained via capacitor C601 at pin 1 of the TDA8362.

6. Vertical output stage with TDA3653B

The TDA3653B is a vertical deflection output circuit for drive of various deflection systems with currents up to 1.5A peak-to-peak.

Pin 43 of TDA8362 is connected to pin 1, the input for the driver of the output stage via R305.

During scan the capacitor between pin 6 and 8 (C308) is charged. When the flyback starts and the voltage at the output pin 5 exceeds the supply voltage at pin 9, the flyback generator is activated. The supply voltage is then connected in series, via pin 8, with the voltage across capacitor C308 during the flyback period. This implies that the supply voltage can be reduced to the required scan voltage plus the saturation voltage of the transistors.

The vertical synchronization information required by a µ-processor, available at pin 6 is obtained via R307, D303. Furthermore transistor QT08 has been added for de-interlace of Teletext signals.

7. Horizontal Deflection stage

The horizontal drive pulses, pin 37 of TDA8362, are connected to the base of driver transistor Q401 via resistor R404. The base current of the driver transistor is supplied via R403 (pin 37 is an open collector output).

The driver transformer (T401) drives deflection transistor Q402.

T402 is EHT transformer (Flyback transformer) and generates the EHT-, focus- and G2-voltage, required by the picture tube. Furthermore the +185V supply and heater voltage are derived from this transformer

At pin 7 the beam current information is measured via resistor R412. This information is used for reducing the contrast and Brightness at too high beam currents (Via D701 and D703).

The flyback voltage is clipped between +8V and ground by diodes D408, D409 to obtain a well shaped flyback pulse for feedback to the TDA8362 (pin 38).

A horizontal synchronization information required by a possible μ -processor is obtained via R417, D407 and QV15 connected at pin 3 of the FBT.

8. Power supply with TDA4601.

TDA4601 is designed for driving, controlling, and protecting the switching transistor in flyback converter power supplies during start-up, normal, and overload operation as well as during disturbed operation.

TDA4601 drives as start voltage (16V_{DC}) being supplied at pin 9 of TDA4601.

Continually, voltage (180V_{AC} → 13V_{DC}, 270V_{AC}, 20V_{DC}) is supplied at pin 6 of SMPS transformer (TSM-4020).

The function of power ON/OFF is activated by using switching transistor Q801 (2SD1555).

The pin 1 of TDA4601 is REFERENCE VOLTAGE PIN, pin 2 is AIR GAP PORT, pin 3 is the ADJUSTMENT PORT of secondary B+ level, pin 4 is AMP CONTROL PORT, pin 7 is the ELECTRIC DISCHARGE PORT of switching transistor, and pin 8 is OUTPUT VOLTAGE to drive switching transistor

The main secondary B+ voltage is set by VR801 to 103 VDC with the picture control set at maximum.

The protective operating mode of TDA4601 is that the base current shut-down activated by the control logic clamps the output of pin 7 to 1.6V_{DC}.

As a result, the drive of switching transistor is inhibited.

This protective measure is enabled if the supply voltage at pin 9 reaches a value 6.7V.

■ INSTALLATION & SERVICE ADJUSTMENTS

GENERAL INFORMATION

All adjustments are thoroughly checked before the receiver leaves the factory. Therefore the receiver should operate normally and produce proper colour and B/W pictures upon installation. But, several minor adjustments may be required depending on the particular location in which the receiver is operated. This receiver is shipped completely in a cardboard carton. Carefully draw out the receiver from the carton and remove all packing materials.

Plug the power cord into a AC power outlet. Turn the receiver ON and adjust the FINE TUNING for the best picture detail. Check and adjust all the customer controls such as BRIGHTNESS, CONTRAST and COLOUR Controls to obtain a natural picture.

HIGH VOLTAGE CHECK

1. Connect an accurate high voltage meter to the anode of the picture tube.
2. Turn on the receiver. Set the BRIGHTNESS and CONTRAST controls to minimum (zero beam current).
3. High voltage should be below 27.5kv (14": 25.0kv.)

PURITY / DEGAUSSING

A degaussing coil is mounted around the picture tube so that external degaussing after moving the receiver is normally not necessary. Providing the receiver is properly degaussed upon installation. The degaussing coil operates for about 1 second after the power of the receiver is switched ON. If the set is moved or placed in a different direction, the power switch must be switched off for at least 15 minutes in order to make the automatic degaussing circuit operate properly.

Should the chassis or parts of the cabinet become magnetized to cause poor colour purity, use an external degaussing coil. Slowly move the degaussing coil around the faceplate of the picture tube, the sides and front of the receiver and slowly withdraw the coil to a distance of about 2m before disconnecting it from the AC source.

If colour shading still persists, perform the COLOUR PURITY ADJUSTMENT and CONVERGENCE ADJUSTMENTS procedures, as mentioned later.

■ DYNAMIC CONVERGENCE ADJUSTMENT

Dynamic convergence (convergence of the three colour field at the edges of the CRT screen) is accomplished by proper insertion and positioning of three rubber wedges between the edges of the deflection yoke and the funnel of the CRT. This is accomplished as follows:

1. Switch the receiver on allow it to warm up for 15 minutes.
2. Apply crosshatch pattern from dotbar generator to the receiver. Observe misconvergence between lines around edges of the CRT screen.
3. Tilt the deflection yoke up and down, and insert tilt adjustment wedges 1 and 2 between the deflection yoke and the CRT until the misconvergence illustrated in figure. 2 (A) has been corrected.
4. Tilt the deflection yoke right and left, and insert tilt adjustment wedge 3 between the deflection yoke and the CRT until mis-convergence illustrated in figure. 2 (B) has been corrected.
5. Alternately change spacing between, and depth of the insertion of, the three wedges until proper dynamic convergence is obtained.
6. Use a strong adhesive tape to firmly secure latch of the three rubber wedges to the funnel of the CRT.
7. Check purity and readjust, if necessary.

■ STATIC (CENTRE) CONVERGENCE ADJUSTMENT

1. Switch the receiver on and allow it to warm up for 15 minutes.
2. Connect the output of a crosshatch generator to the receiver and concentrating on the centre of the CRT screen, proceed as follow;
 - a. Locate the pair of 4 pole magnet rings.
Rotate individual rings (Change spacing between tabs) to converge the vertical red and blue lines.
Rotate the pair of rings (maintaining spacing between tabs) to converge the horizontal red and blue lines. (Refer to fig. 1 (A))
 - b. After completing red and blue centre convergence, locate the pair of 6 pole magnet rings. Rotate individual rings (change spacing between tabs) to converge the vertical red and blue (Magenta) and green lines. Rotate the pair of rings (maintaining spacing between tabs) to converge the horizontal red and blue (Magenta) and green lines. (Refer to Fig. 1(B))

■ COLOUR PURITY ADJUSTMENT

For the best result, it is recommended that the purity adjustment is made in final receiver location. If the receiver will be moved, perform adjustment with it facing east. The receiver must have been operating 15 minutes prior to this procedure and the faceplate of the CRT must be at room temperature. The receiver is equipped with an automatic degaussing circuit. But, if the CRT shadow mask has come excessively magnetized, it may be necessary to degauss it with manual coil. Do not switch the coil.

The following procedure is recommended while using a generation.

1. Check for correct location of all neck components (See figure. 5).
2. Rough-in the static convergence at the centre of the CRT, as explained in the static convergence procedure.
3. Rotate the picture control to centre of its rotation range, and rotate brightness control to max. clockwise position.
4. Apply green colour signal to produce a green raster.
5. Loosen the deflection yoke tilt adjustment wedges (3), loosen the deflection yoke clamp screw and push the deflection yoke as close as possible to the CRT screen.
6. Begin the following adjustment with the tabs on the round purity magnet rings set together, initially move the tabs on the round purity magnet rings to the side of the CRT neck. Then, slowly separate the two tabs while at the same time rotating them to adjust for a uniform green vertical band at the CRT screen.
7. Carefully slide the deflection yoke backward to achieve green purity. (uniform green screen) Centre purity was obtained by adjusting the tabs on the round purity magnet rings, outer edge purity was obtained by sliding the deflection yoke forward. Tighten the deflection yoke clamp screw.
8. Check for red and blue field purity by applying red signal and touch up adjustments, if required.
9. Perform black and white tracking procedure.

■ SCREEN & WHITE BALANCE ADJUSTMENT

1. This adjustment is to be made only after warming up at least 15 minutes.
2. Receive B/W pattern signal
3. Set the RGB Bias VR (R522, R512, R502) to MINIMUM.
4. Set the G, B Drive VR (R515, R505) to CENTER.
5. Set the CONTRAST, BRIGHTNESS, COLOUR control to MIN, and Sub-brightness control to CENTER.
6. Rotate the SCREEN control to clockwise or counterclockwise, until the last beam disappears on the screen.
7. Rotate the R, G and B Bias VR of the other colour which did not appear on the screen clockwise, until a white picture is obtained.
8. Rotate the Screen control gradually anticlockwise until the last beam disappears on the screen.

9. Set the CONTRAST, BRIGHTNESS, COLOUR control to MAX.
10. Set the G, B Drive VR to obtain the best white uniformity on the screen.
11. Rotate the CONTRAST, BRIGHTNESS, COLOUR controls until a dim raster is obtained and touch-up adjustment of RGB Bias VR to obtain the best white uniformity on the screen.

■ SUB-BRIGHTNESS ADJUSTMENT

1. White balance adjustment must precede this procedure.
2. Set the CONTRAST, BRIGHTNESS, COLOUR control to MIN
3. Rotate the SUB-BRIGHTNESS VR (VR701) gradually anticlockwise until the last beam disappears on the screen.

■ VERTICAL HEIGHT ADJUSTMENT

1. Receive RETMA pattern signal.
2. Set the BRIGHTNESS control and CONTRAST control to MAX., and the COLOUR control to center.
3. Adjust VR301 for the optimum vertical height and over scanning.

■ VERTICAL CENTER ADJUSTMENT

1. Receive RETMA pattern signal.
2. Adjust VR302 so that the vertical center of the picture may be coincident with the mechanical center of CRT.

■ HORIZONTAL CENTER ADJUSTMENT

1. Receive RETMA pattern signal.
2. Adjust VR401 so that the horizontal centre of the picture may be coincident with the mechanical centre of CRT.

■ FOCUS VOLTAGE ADJUSTMENT

1. Receive RETMA pattern signal.
2. Adjust the FOCUS CONTROL on the FBT for the clearest picture.

■ **RF AGC ADJUSTMENT**

1. Receive PAL COLOUR BAR signal in the VHF high band where the strength of signal can be 60-65 dB.
2. Set the CONTRAST control to Max., the BRIGHTNESS control to provide adequate black and grey scales.
3. With the fine tuning maintained set VR101 (AGC DELAY CONTROL VR.) to the position where the noise on the picture just disappears.

■ **MAIN B+ (+103V) ADJUSTMENT**

1. Receive RETMA pattern signal.
2. Set the picture level to NORMAL I mode.
3. Connect DC voltage meter to the TP6 and adjust VR801 for +103V DC.

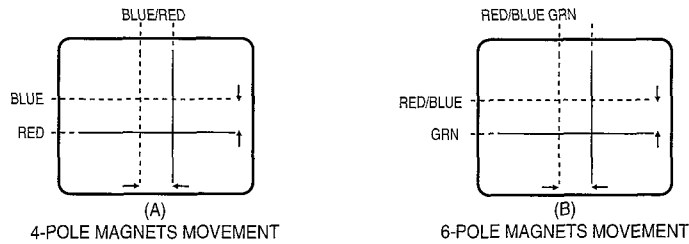

FIG. 1 CENTRE CONVERGENCE BY CONVERGENCE MAGNETS

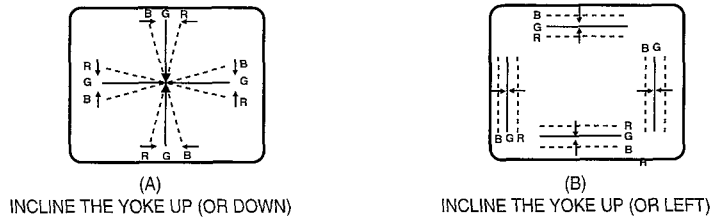

FIG. 2 CIRCUMFERENCE CONVERGENCE BY DEF. YOKE

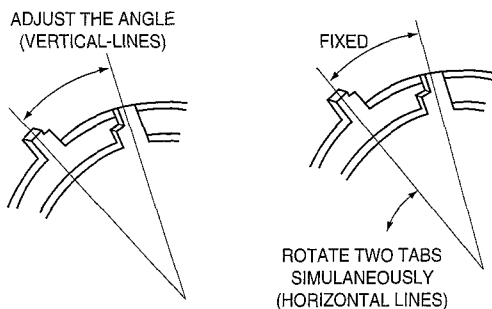

FIG. 3 ADJUSTMENT OF MAGNETS

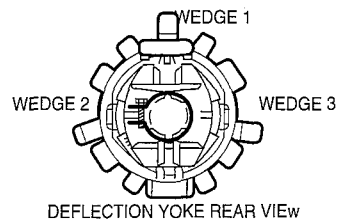

FIG. 4 RUBBER WEDGE LOCATION

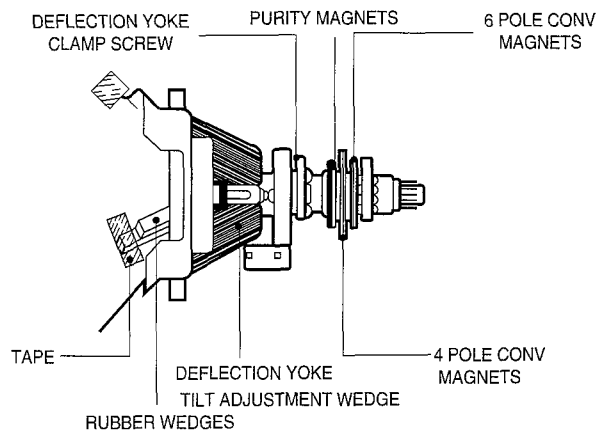

FIG. 5 PICTURE TUBE NECK COMPONENT

■ PIF ADJUSTMENT

I. APPARATUS CONNECTION & PRESETTING

*CONNECTION

1. Connect H-out of LSW-480 to X-axis of the oscilloscope and V-out LSW-480 to Y-axis of the oscilloscope.
2. Connect the sweep signal output to TP1
3. Set ATTENUATOR of LSW-480 to 30dB.
4. Supply 15V D.C. voltage (B+) to TP4.
5. Supply 4-5V D C voltage to TP3.
6. Connect wire lead between cathode of D401 & I401#3

*PRESET

- 1) Oscilloscope Scaling
 - a) Put the scale of X and Y of the oscilloscope to D.C level
 - b) Set the horizontal time display to X-Y
 - c) Put the horizontal axis (X) to 1V/div. and the vertical axis (Y) to 2V/div.
- 2) LSW-480 MARKER PREQ. SETTING.

	fp(n+1)	fs	fc	fp-2	fp	fs(n-1)
B/G, D/K, L	31.9	33.4	34.5	36.9	38.9	40.4
I	31.5	33.5	35.07	37.5	39.5	41.5

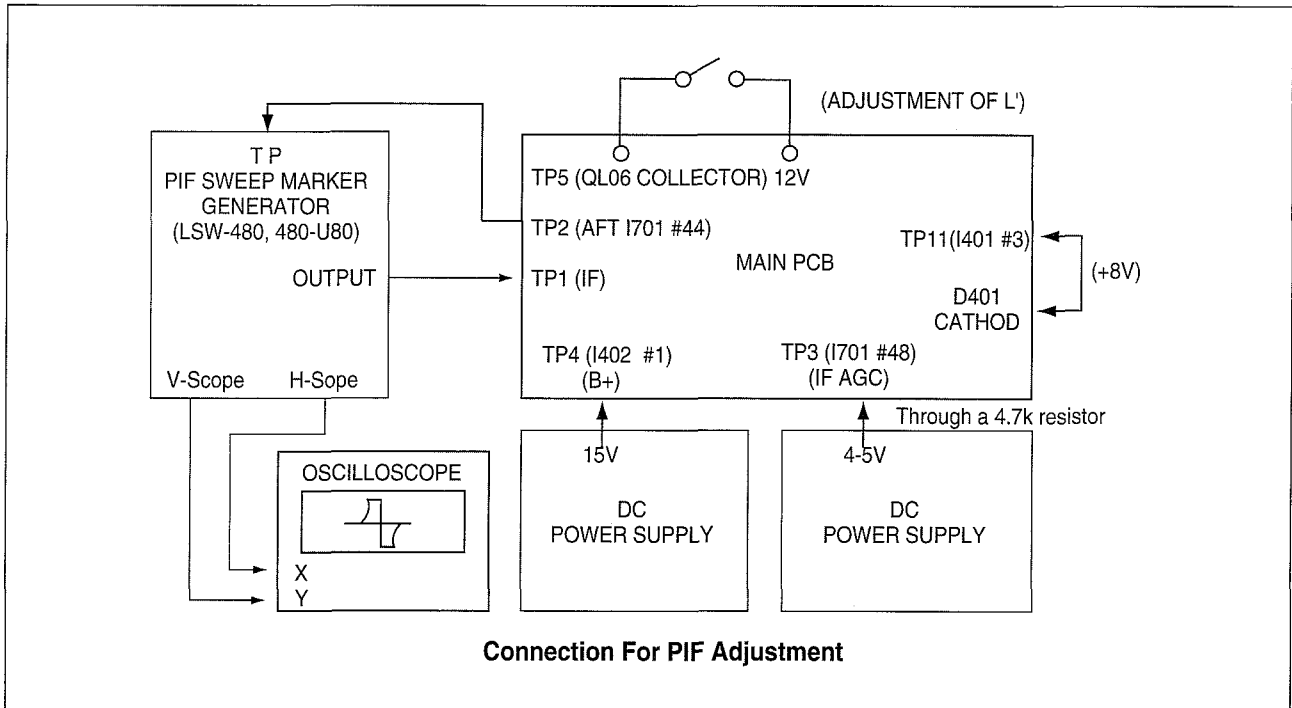

II. ADJUSTMENT OF AFT(B/G, D/K, I, L)

1. Connect the test point of LSW-480 to TP2
2. Adjust L 103(AFT COIL) so that the P marker point is located on the reference level.

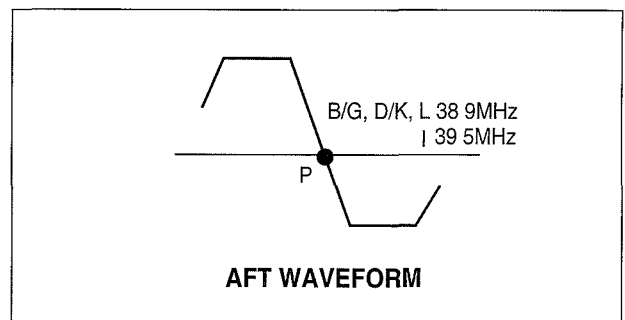

III. ADJUSTMENT OF SECAM-L' AFT

1. Connect TP5 (QL06 collector) to +12V.
2. Adjust CL09 (L' AFT TRIMMER) so that the C marker point (34.5MHz) is located on the reference level.

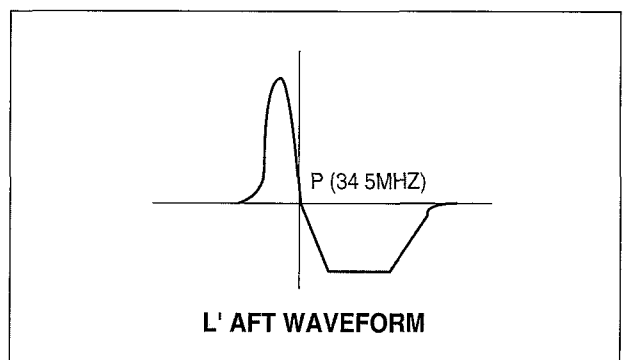

■ POSITION OF ADJUSTMENT CONTROLS

MAIN PCB

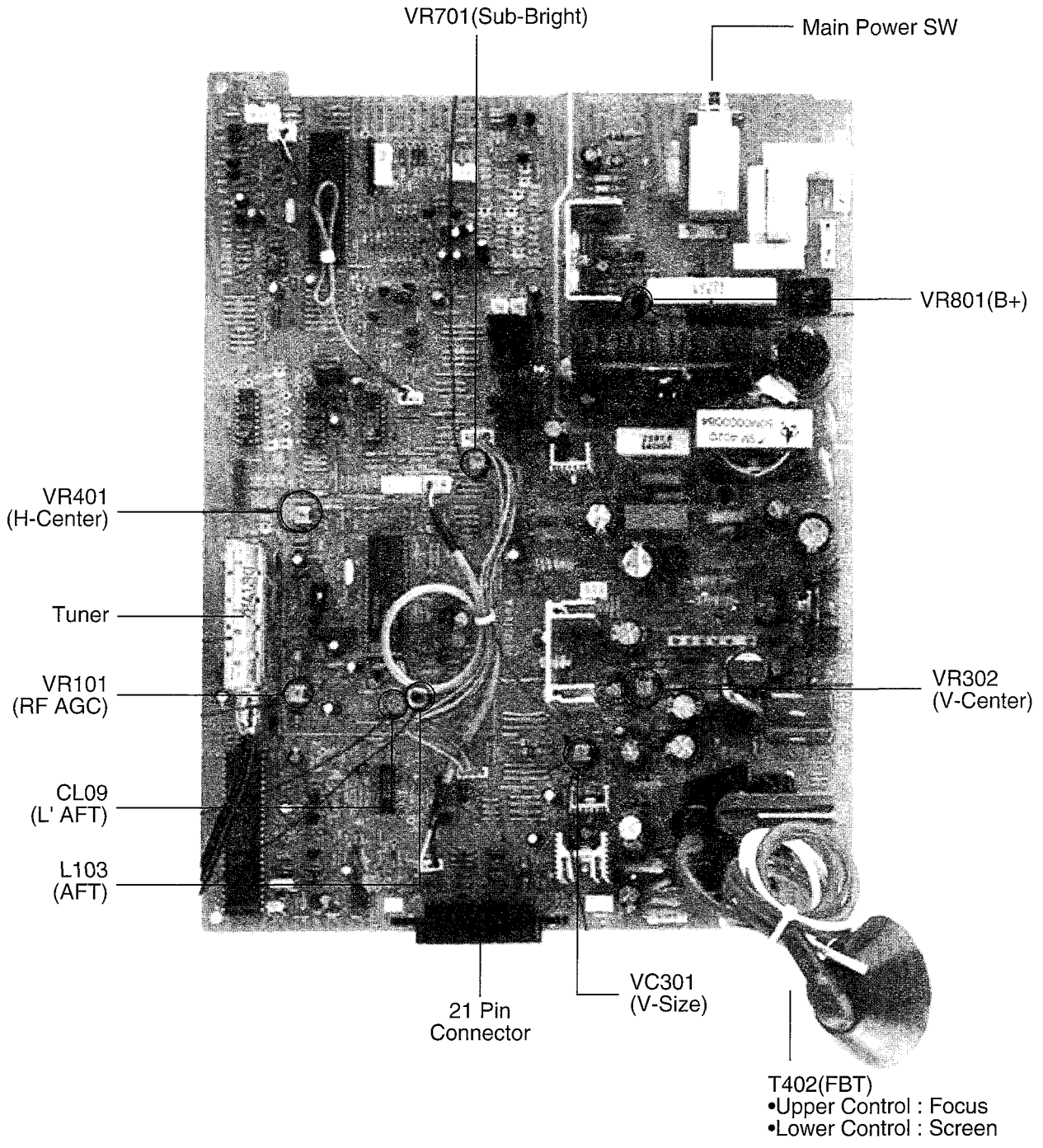

CRT PCB

S/N 4859809213

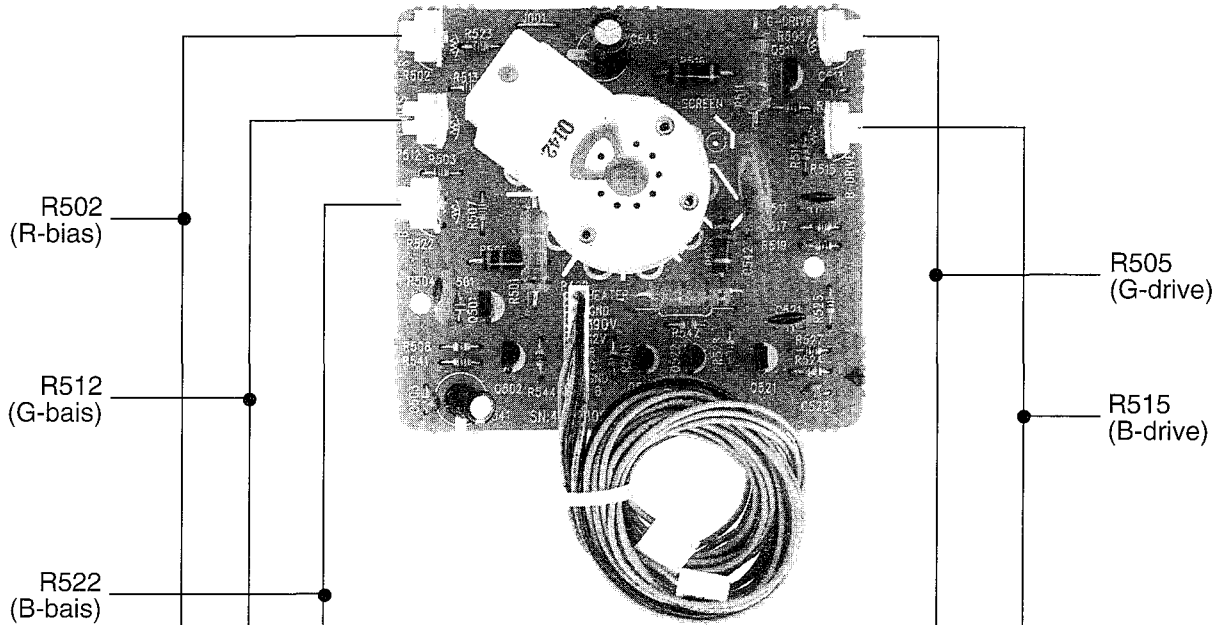

S/N 4859809313

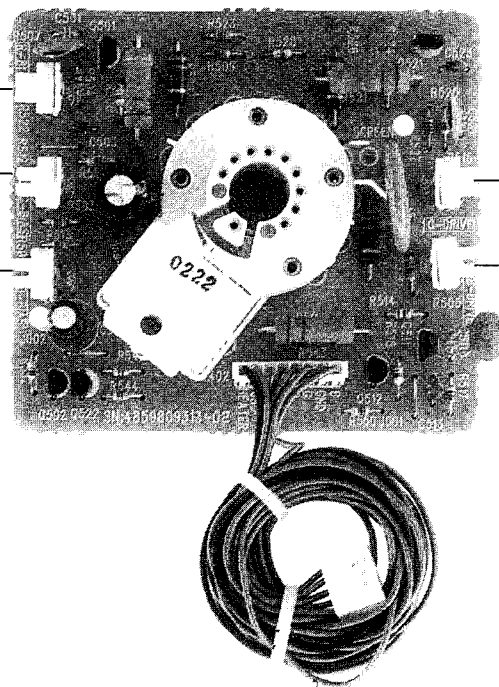

■ VOLTAGE TABLES (Main PCB)

The following voltages were taken with brightness, colour and contrast set to give normal viewing levels

IV01			
Pin	Volts	Pin	Volts
1	depends on tuning	28	-(option key scan out)
2	0V1 to 5V0 (volume)	29	not used
3	0V1 to 5V0 (brightness)	30	not used
4	0V1 to 5V0 (colour)	31	not used
5	0V1 to 5V0 (contrast)	32	0V
6	0V1 to 5V0 (peak)	33	0V (5V OSD red out)
7	0V1 to 5V0 (tint)	34	0V (5V OSD green out)
8	not used	35	not used
9	0V (5V audio mute)	36	0V (5V OSD blank)
10	0V (5V video mute)	37	5V (0V H.SYNC)
11	12V (0V BL)	38	5V (0V V.SYNC)
12	12V (0V BH)	39	4V8
13	12V (0V BU)	40	4V8
14	0V (5V SECAM-L')	41	5V (0V no signal)
15	0V (5V stand-by)	42	0V (GND)
16	0V (5V on-timer)	43	2V0
17	0V (5V SECAM/NTSC)	44	2V6
18	not used	45	5V
19	2V5 (AFT)	46	0V (5V scart input)
20	-(key scan)	47	iR input
21	-(key scan)	49	not used
22	-(key scan)	50	5V (0V AV)
23	-(key scan)	51	5V
24	-(key scan)	52	5V
25	-(option key scan out)	53	0V (5V stand-by)
26	-(option key scan out)	54	5V
27	0V (GND)		

I801	
Pin	Volts
1	4V2
2	0V3
3	2V2
4	2V2
5	3V3
6	0
7	1V9
8	1V9
9	13V5

IV02	
Pin	Volts
1	0V
2	0V
3	0V
4	0V
5	5V (SDA)
6	5V (SCL)
7	0V
8	5V

IV03	
Pin	Volts
1	5V
2	0V
3	4.8V

IT01			
Pin	Volts	Pin	Volts
1	5V	25	0V
2	2V5	26	nc
3	3V6	27	nc
4	0V	28	nc
5	0V	29	nc
6	5V	30	nc
7	2V	31	nc
8	2V1	32	nc
9	2V4	33	nc
10	5V	34	nc
11	0	35	nc
12	not used	36	nc
13	5V	37	nc
14	0	38	nc
15	0V2	39	nc
16	0V2	40	nc
17	0V2	41	nc
18	4V7	42	nc
19	0V (4V TEXT)	43	nc
20	not used	44	nc
21	0V (2V5 TEXT)	45	0V
22	not used	46	0V
23	5V	47	0V
24	5V	48	0V

IL01	
Pin	Volts
1	1V8
2	nc
3	2V
4	4V4
5	2V1
6	2V1
7	0V
8	nc
9	nc
10	nc
11	12V
12	nc
13	0
14	nc
15	nc
16	1V8

IA01 (SECAM L SIGNAL)			
Pin	Volts	Pin	Volts
1	5V0	9	8V (3V3 AV)
2	3V4	10	8V (3V3 AV)
3	0V9	11	0
4	0V9	12	4V8
5	nc	13	0V7
6	0	14	4V8
7	0	15	4V8
8	0	16	8V0

IT02	
Pin	Volts
1	0V
2	3V1
3	4V6
4	nc
5	0V (9V AV)
6	3V4
7	12V
8	2V3

I701			
Pin	Volts	Pin	Volts
1	3V (8V SECAM-L)	27	5V7
2	5V9	28	3V9
3	5V9	29	3V9
4	not used	30	1V5
5	2V7 (vol control)	31	1V5
6	3V8	32	1V7
7	4V0	33	4V4
8	1V7	34	2V9
9	0V (GND)	35	2V1
10	8V0	36	8V2
11	0V (GND)	37	0V4
12	3V6	38	0V5
13	4V4	39	3V4
14	4V7	40	3V8
15	3V5	41	2V2
16	0V3 (5V AV)	42	2V9
17	3V7 (bright control)	43	2V6
18	2V3	44	4V7
19	2V3	45	4V
20	2V3	46	4V
21	0V2 (5V OSD blank)	47	5V0
22	3V3	48	4V0
23	3V3	49	2V
24	3V3	50	3V7
25	2V (contrast control)	51	4V5
26	2V7 (colour control)	52	6V5

I301	
Pin	Volts
1	1V2
2	0
3	1V
4	0
5	15V
6	26V
7	nc
8	5V4
9	26V

I601	
Pin	Volts
1	nc
2	12V
3	0V
4	0V
5	nc
6	6V4
7	0
8	6V4
9	nc

I501			
Pin	Volts	Pin	Volts
1	5V0	9	5V0
2	nc	10	0
3	0	11	2V9
4	0	12	2V9
5	0V5	13	nc
6	nc	14	1V5
7	nc	15	nc
8	0	16	1V5

I502(SECAM L SIGNAL)			
Pin	Volts	Pin	Volts
1	4V5	9	3V0
2	nc	10	3V0
3	8V1	11	nc
4	nc	12	nc
5	nc	13	nc
6	0V	14	nc
7	3V3	15	0V5
8	4V2	16	5V7

	QA01	QA02	QA03	QL01 (SECAM L)	QL02 (SECAM L)
C	8V0(0V1 SECAM L)	0V(8V2 SECAM L)	5V	10V7	0V1
B	0V2 (0V7 SECAM L)	8V(7V5 SECAM L)	0V9 (4V1 SECAM L)	0	0V7
E	0V	8V	0V3 (3V4 SECAM L)	0	0

	QL03 (SECAM L)	QL04 (SECAM L)	QL05 (SECAM L)	QL06 (SECAM L)	
C	4V8	0V	12V2	0	
B	2V	0V7	0V2	12V2	
E	1V4	0V	0	12V3	

	QT1	QT05	QT07	QT08	
C	5V	5V	5V (0V6 TEXT)	5V (6V4 TEXT)	
B	0V6 (4V1 TEXT)	4V4 (2V7 TEXT)	4V3	0V7	
E	0V (3V4 TEXT)	5V	5V	0V	

	QV01	QV02	QV03	QV04	QV05
C	varies with tuning	0 to 33V	0V2	0V	12V
B	varies with tuning	varies with tuning	11V5	11V5	11V5
E	0	0	12V	12V	12V

	QV06	QV07	QV08	QV09	QV11
C	3V5 (0V2 stand-by)	3V5 (0V2 on-timer)	8V1	8V	0V1 (9V3 AV)
B	0 (0V7 stand-by)	0 (0V7 on-timer)	0V1	4V9	0V7 (0V AV)
E	0	0	0	4V3	0

	QV13	QV14	QV15	QV16	QV17
C	0	5V1	4V1	4V8	0V3
B	4V7	0	-0V4	-0V5	8V
E	1V8	0	0	0	8V7

	QV18	Q101	Q401	Q402	Q501
C	0	12V	58V4	139V2	0V7
B	0V1	2V4	0V4	0.7	0
E	0	1V6	0	0	0

	Q502	Q503	Q601	Q602	Q603
C	0V	0V0	5V8	8V	5V4
B	0V7	0V7	2V8	5V7	0V9
E	0V	0V	2V7	5V	0V1

	Q701	Q702	Q801	Q805	Q806
C	7V6	7V9	333V2	0V8 (0V stand-by)	0V8 (13V4 stand-by)
V	3V1	2V3	0V7	0V (0V7 stand-by)	0V8 (0V stand-by)
E	2V4	1V7	0V	0V	0V

■ VOLTAGE TABLES (CRT PCB)

	Q501	Q502	Q511	Q512	
C	156V	0V	156V	0V	
B	3V	2V1	3V	2V1	
E	2V4	2V8	2V4	2V8	

	Q521	Q522			
C	156V	0V			
B	3V	2V1			
E	2V4	2V8			

WAVEFORMS

THE FOLLOWING WAVEFORMS WERE TAKEN WHILST RECEIVING A COLOUR BAR SIGNAL.

IV01
Pin 1

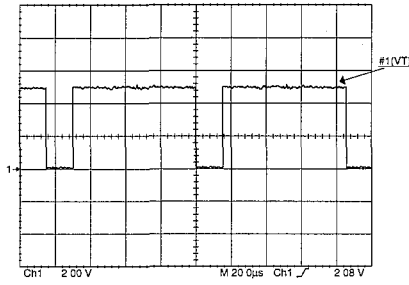

IV01
Pin 43

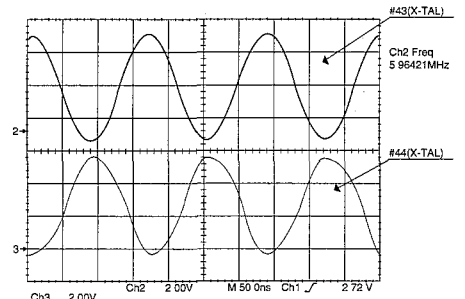

IV01
Pin 2

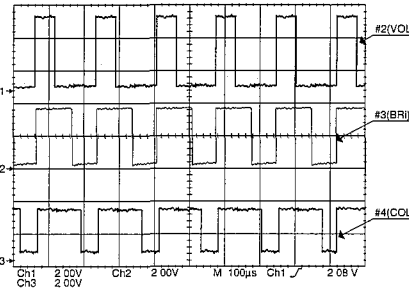

I701
Pin 1

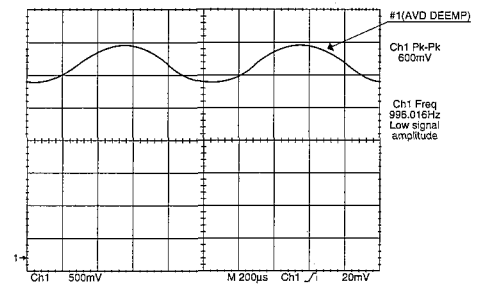

IV01
Pin 5

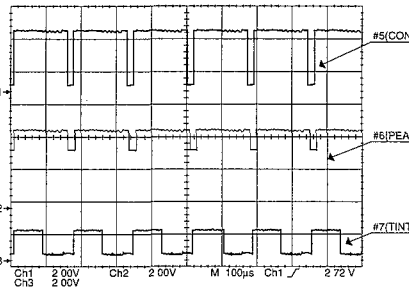

I701
Pin 2

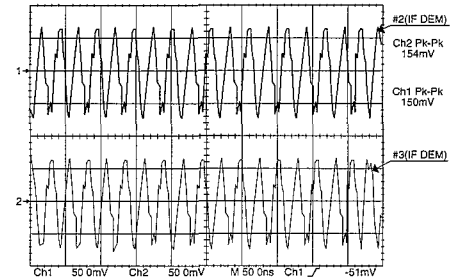

IV01
Pin 37

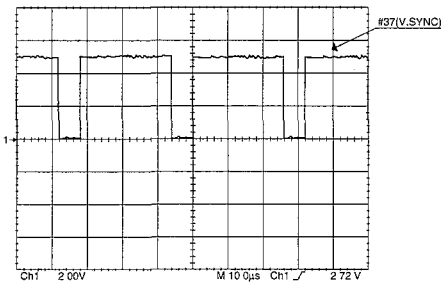

I701
Pin 5

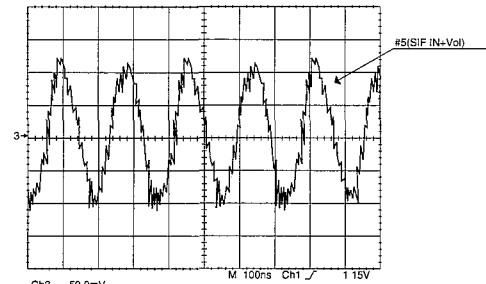

IV01
Pin 38

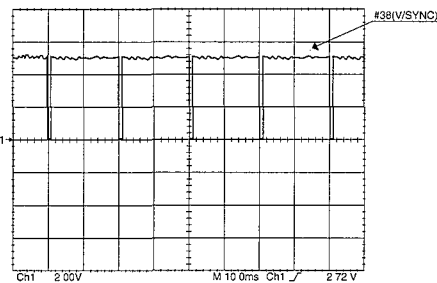

I701
Pin 7
I701
Pin 13
(Colour Bar
Pattern
with
Colour
Off)

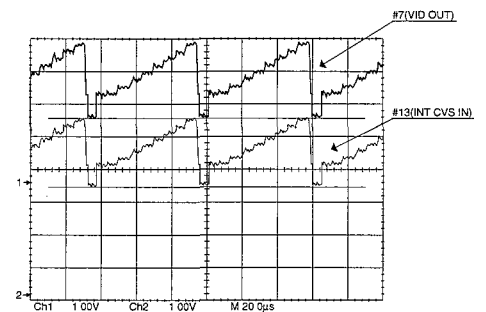

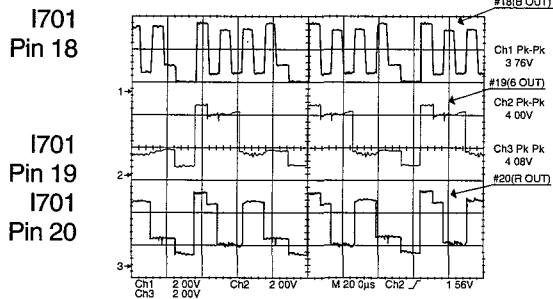

I701
Pin 40

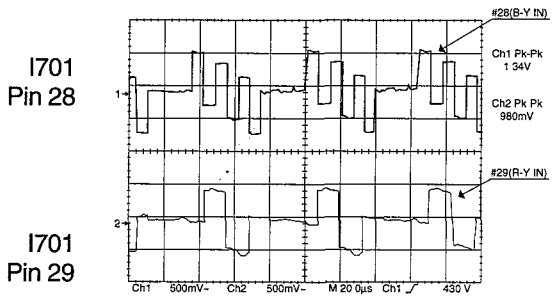
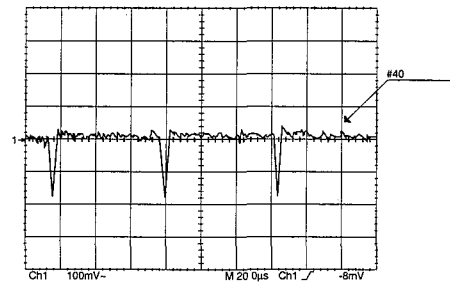

I701
Pin 41
I701
Pin 42
I701
Pin 43

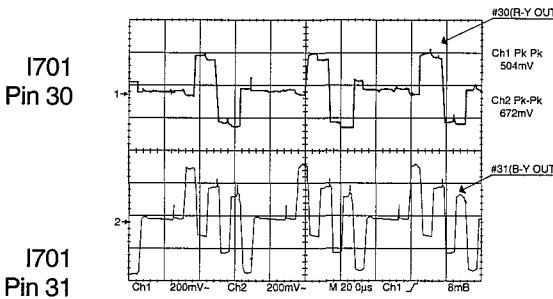
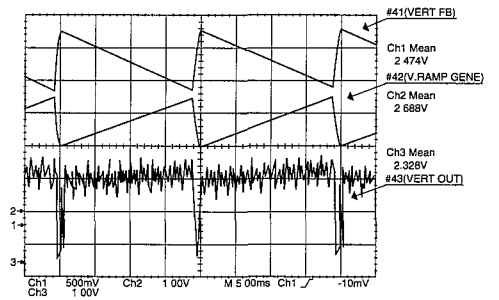

I701
Pin 11
I701
Pin 16

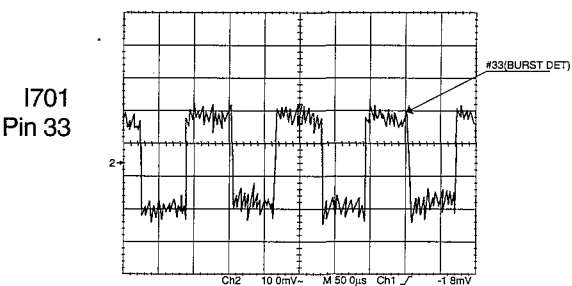
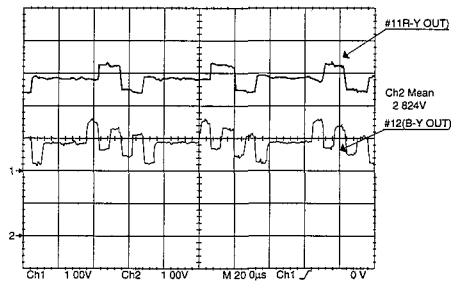

I701
Pin 14
I701
Pin 16

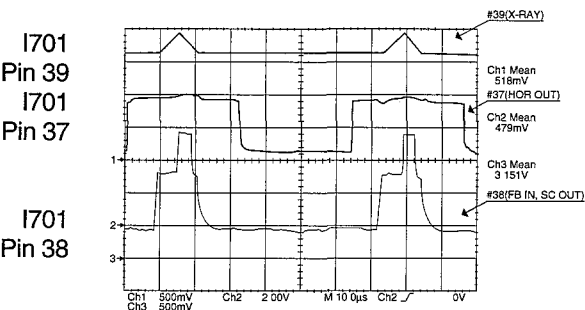
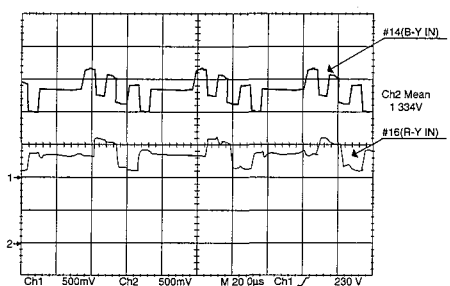

IT01
Pin 2
IT01
Pin 3

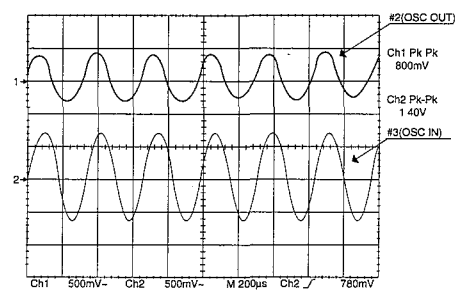

IT01
Pin 8

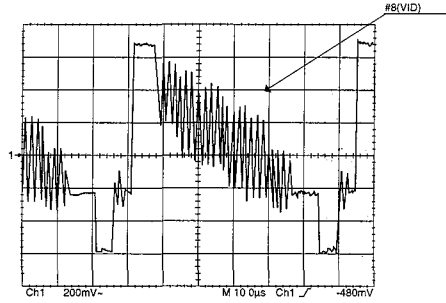

I601
Pin 3

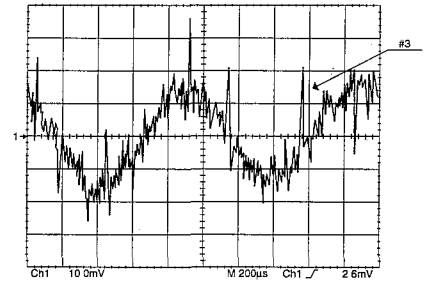

I301
Pin 1

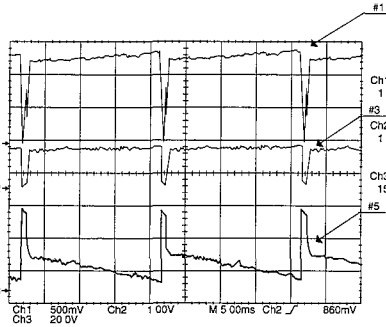

I301
Pin 3

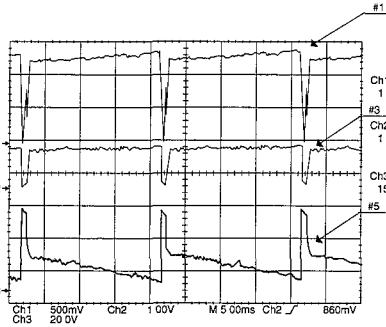

I301
Pin 5

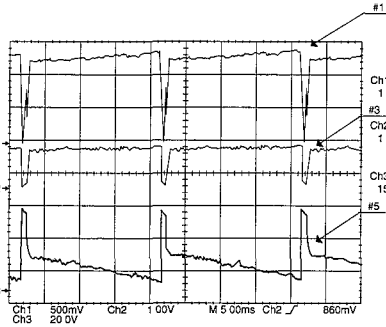

I601
Pin 8

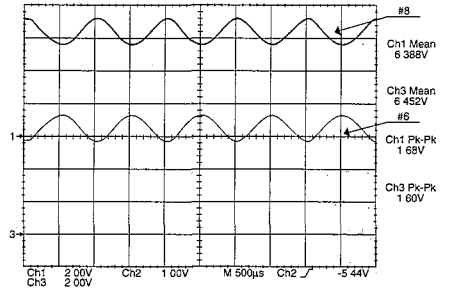

I601
Pin 6

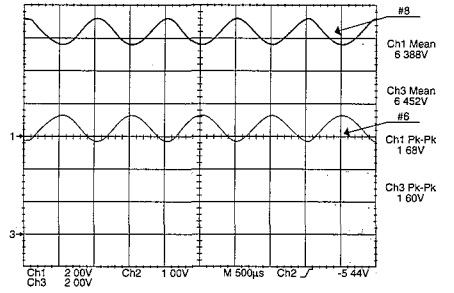

I301
Pin 6

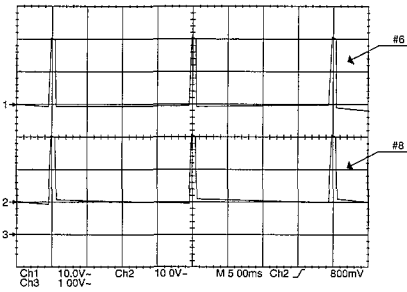

I301
Pin 8

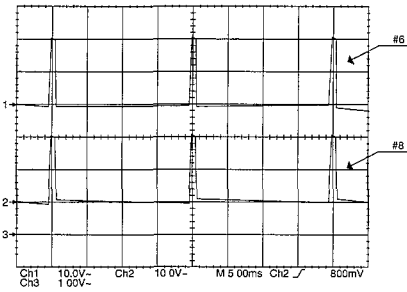

I801
Pin 2

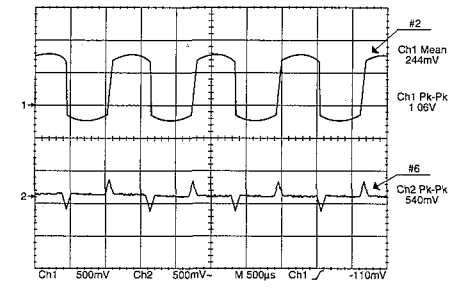

I801
Pin 6
(TV In Stand-By Mode)

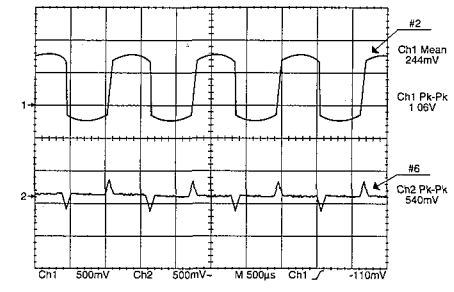

IT02
Pin 2

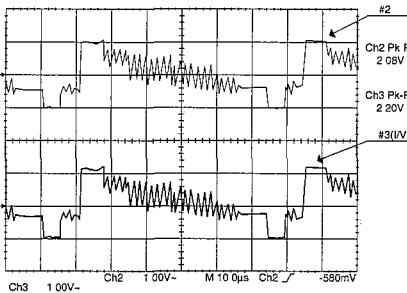

IT02
Pin 3

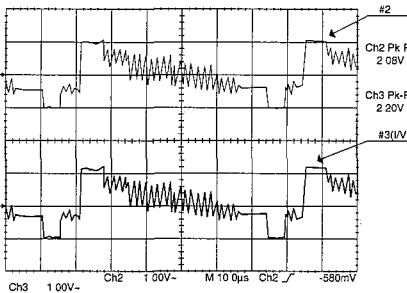

I801
Pin 7
(TV In Stand-By Mode)
I801
Pin 8

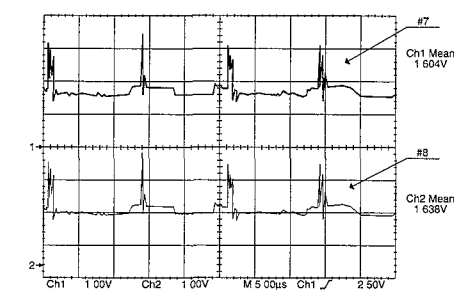

IT02
Pin 6

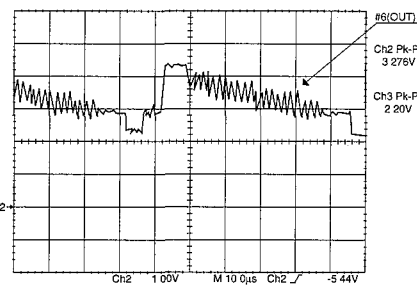

I801
Pin 2

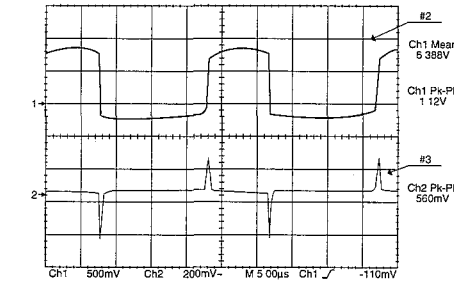

I801
Pin 3
(TV In Normal Mode)

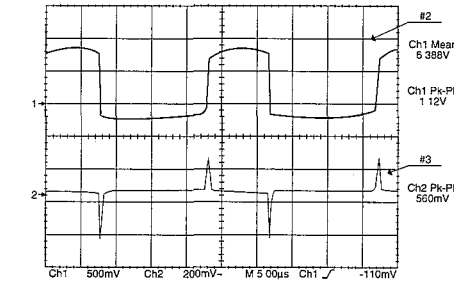

I801
Pin 4
(TV IN NORMAL
MODE)

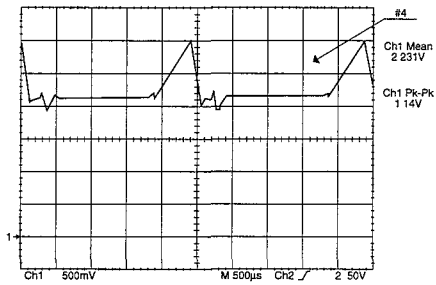

I502
Pin 9

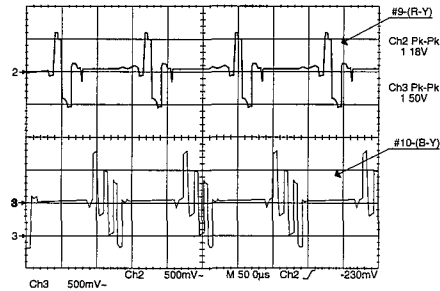

I502
Pin 10
(SECAM-L
SIGNAL)

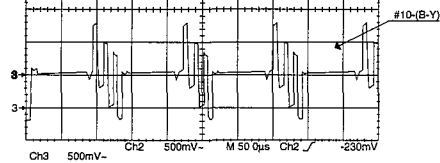

IL01
Pin 1

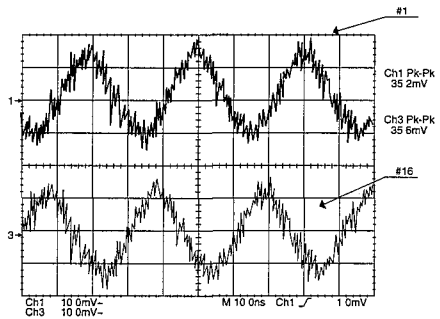

IL02
Pin 16
(SECAM-L
SIGNAL)

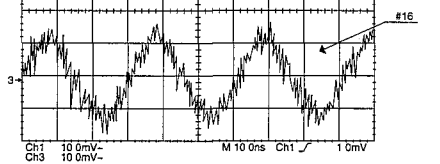

Q402
Base

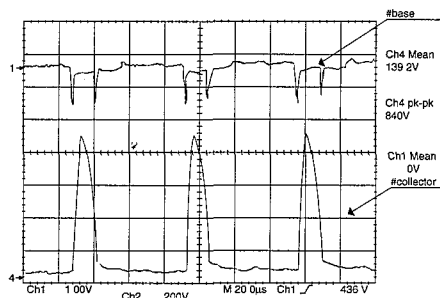

Q402
Collector

Q521
Base
Q521
Collector

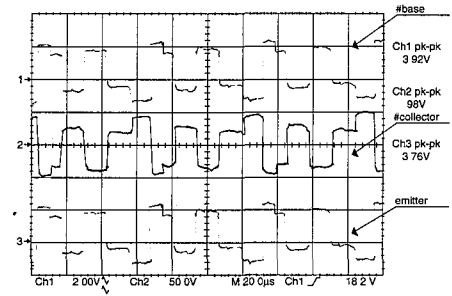

Q521
Emitter

QV15
Base

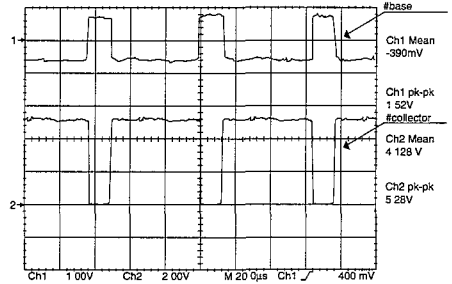

QV15
Collector

QV16
Base

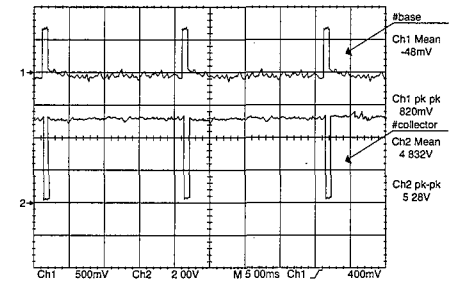

QV16
Collector

Q401
Base

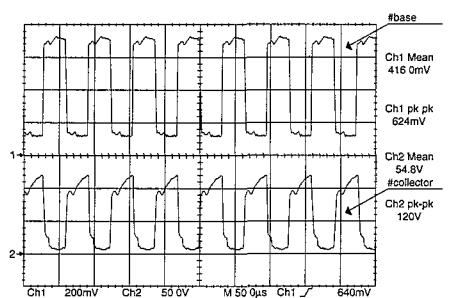

Q401
Collector

Q801
Base



Q801
Collector

Q601
Collector

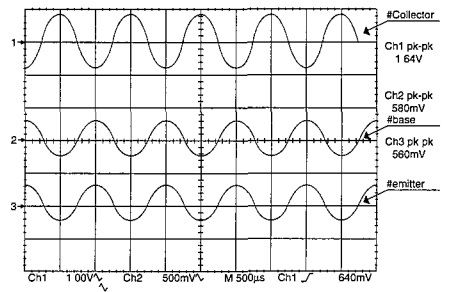

A601
Base
Q601
Emitter

Q603
Collector
Q603
Base
Q603
Emitter

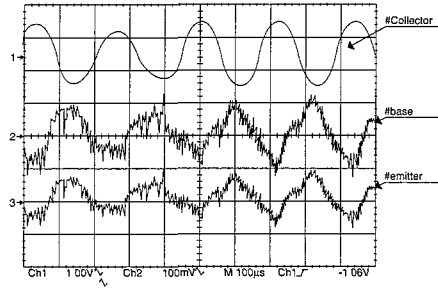

Q701
Collector
Q701
Base
Q701
Emitter

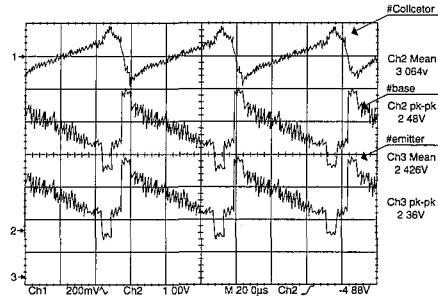

Q702
Collector
Q702
Base
Q702
Emitter

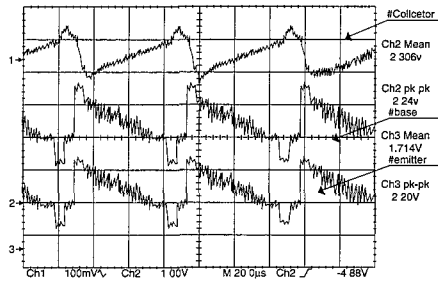

QL03
Base
QL03
Collector
QL03
Emitter

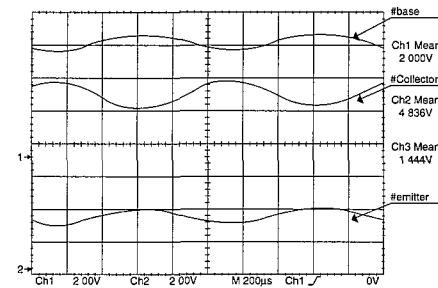

PRINTED CIRCUIT BOARDS

MAIN PCB

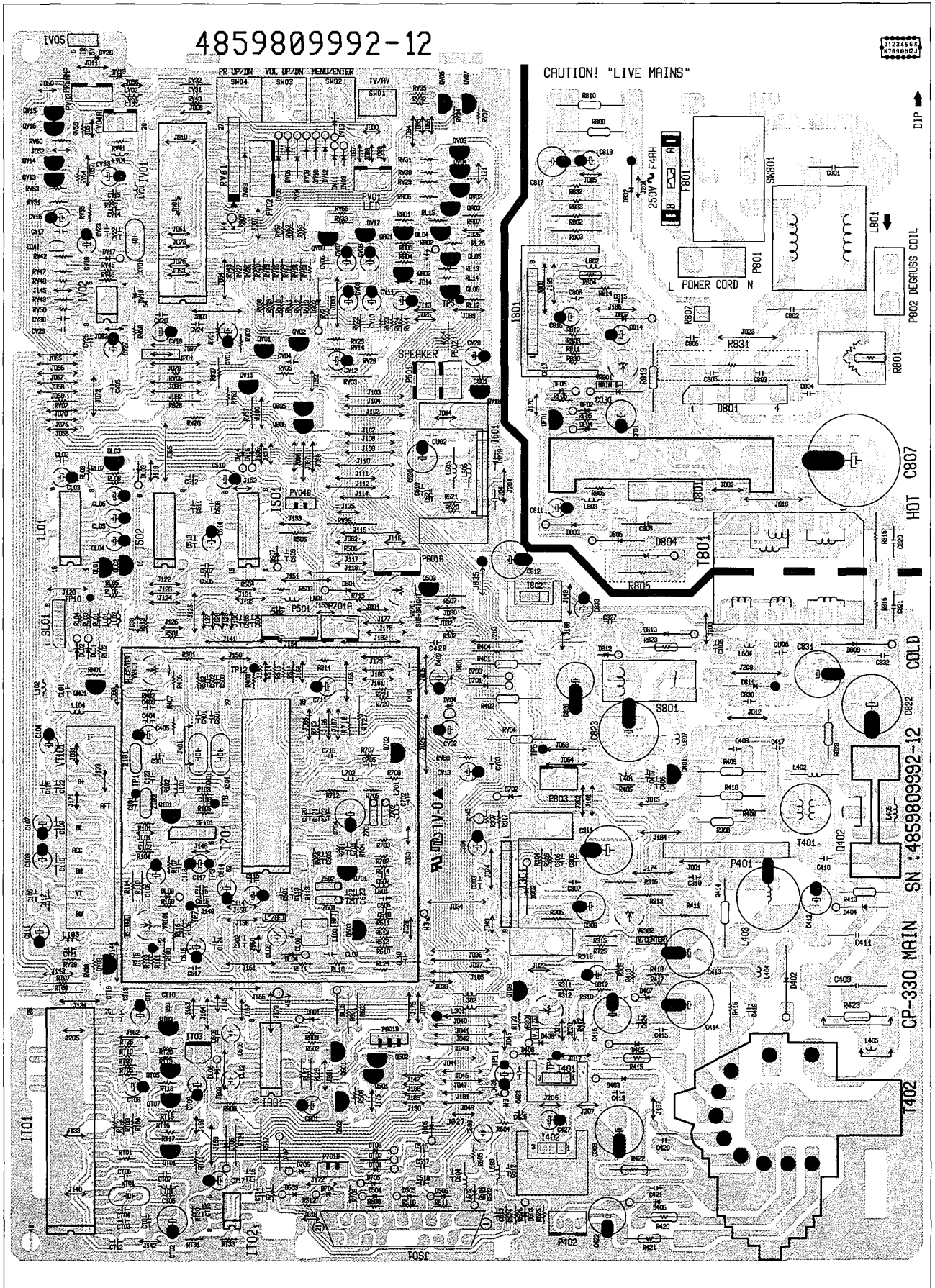

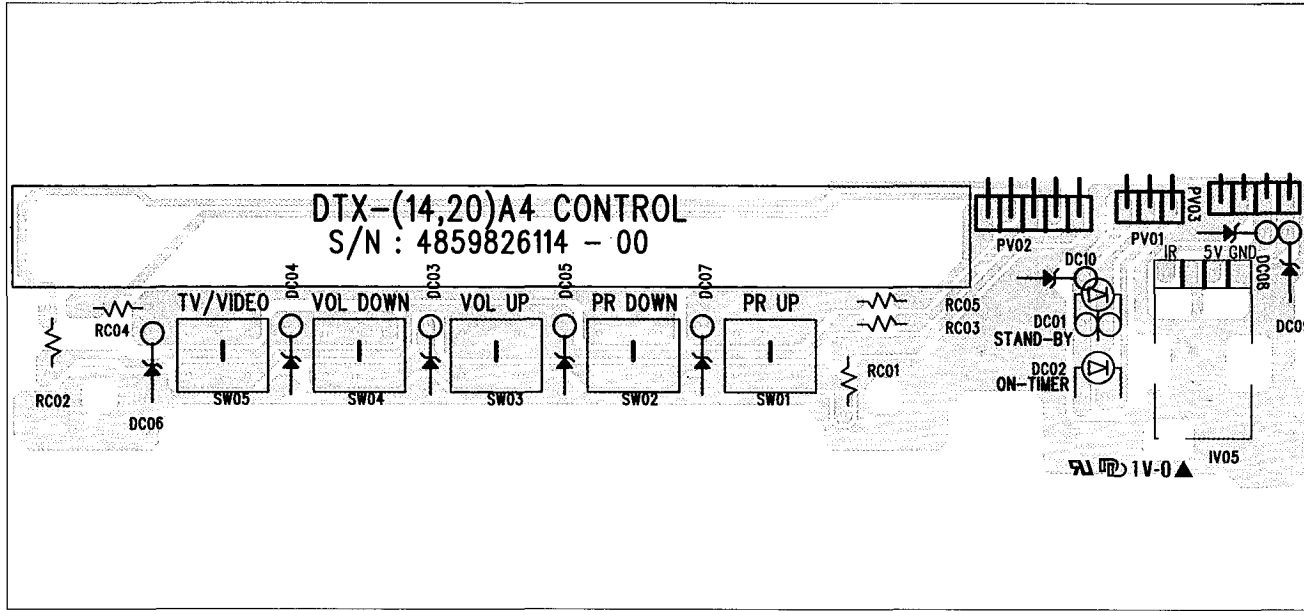
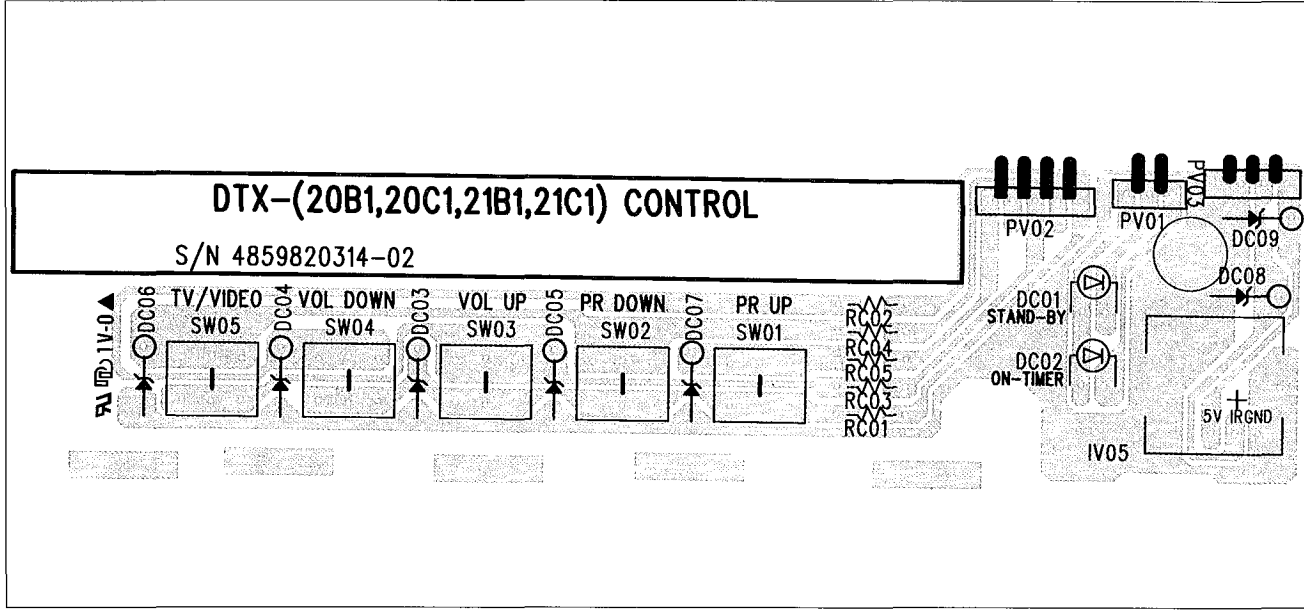

CRT PCB

SN : 4859809213

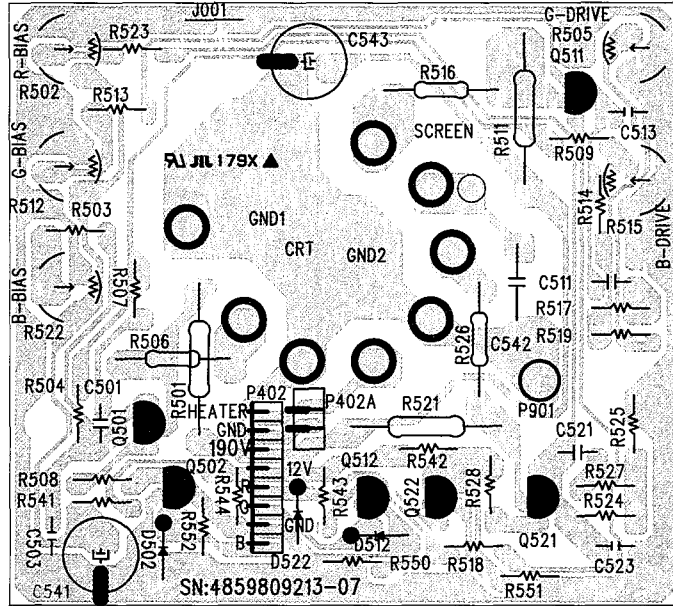

SN : 4859809313

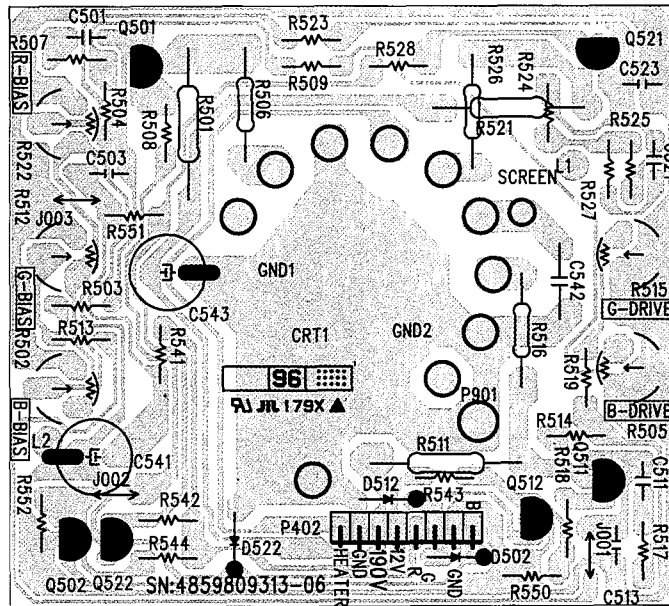

SCHEMATIC DIAGRAM

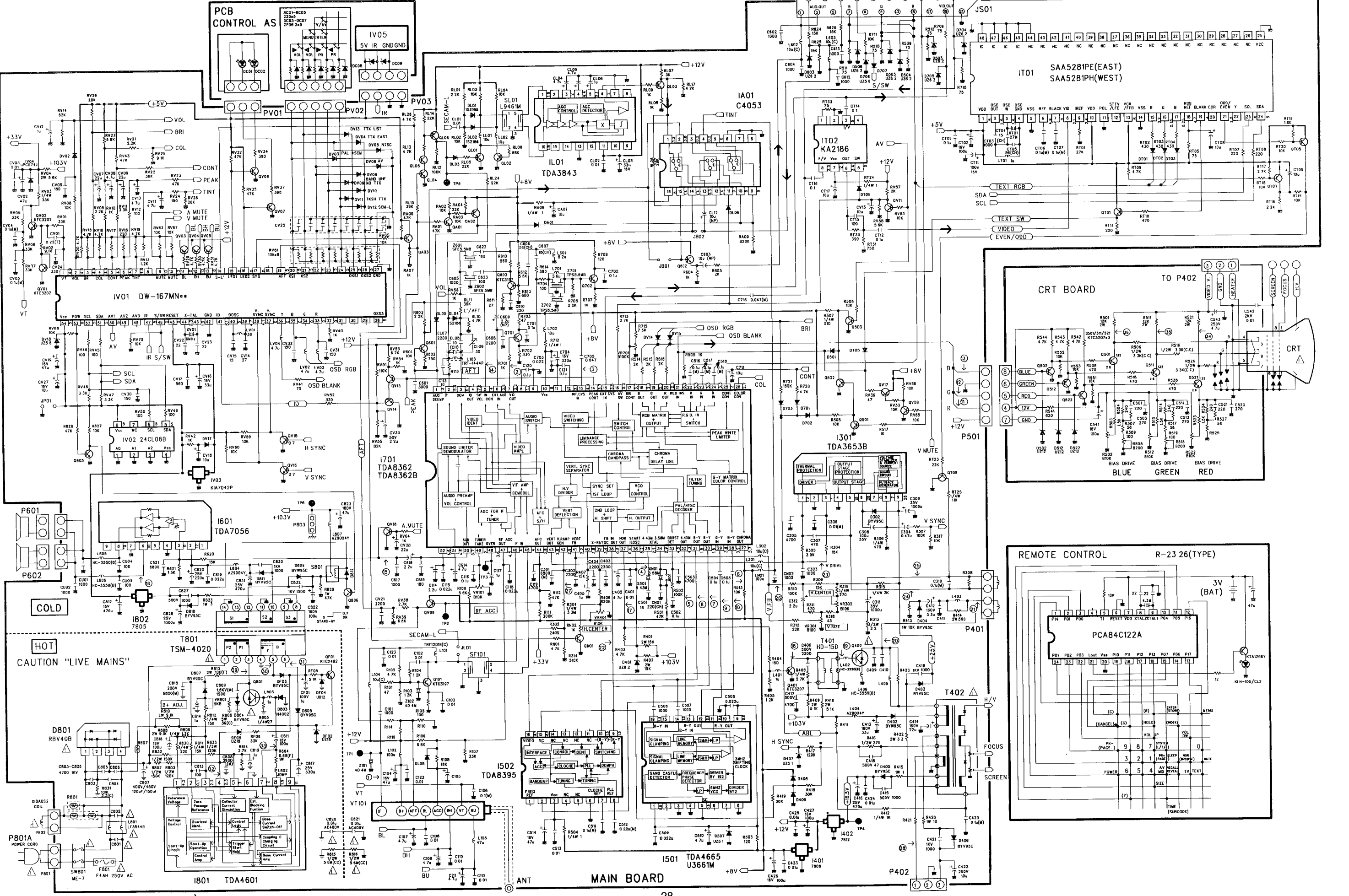

PRESENTATION PARTS

⚠ CRT Type A34JLL90X(ORION)	DE4859607140
A34EAC01X(PHILIPS)	DE4859606240
A48JLL90X(ORION)	DE4859606440
A48EEV33X(T/POLKOLOR)	DE4859611260
A48ECR31X(SAMSUNG)	DE4859621660
A51JSW90X(ORION)	DE4852140600
A51EAL155X01(PHILIPS)	DE4859607660
⚠ Cabinet Back (1411)	DE4852140600
(2011)	DE4852140500
(2111)	DE4852134401
Cabinet Front Frame (1411)	DE4852053801
(2011)	DE4852053701
(2111)	DE4852046901
HITACHI BADGE(1411)	DE4855613600
(2011/2111)	DE4855617500
Mains Lead and Moulded Plug(CW4232 for Continent)	DE4859903110
(CW3222 for U.K)	DE4859905110
Operating Guide	
Quick Guide	
Remote Control Handset Type R-23 (With TEXT)	DE48B2823A01
R-26(Without TEXT)	DE48B2823A01
Remote Control Window (Cabinet)-(1411)	DE4855524801
(2011)	DE4855524701
(2111)	DE4855518901

MISCELLANEOUS PARTS

⚠ CRT Socket Type ISM-01	DE4859301530
ISH-04	DE4859301930
⚠ Degaussing Coil Type DC-1450(for 1411)	DE58G0000084
DC-2050(for 2011)	DE58G0000086
DC-2070(for 2111)	DE58G0000074
⚠ Fuse Type F4AH 250V AC	DE5FSCB4022R
Fuse Holder	DE4857415001
⚠ ON/OFF Switch	DE5S40102073
21 Pin Scart Socket	DE4859200401
Speaker(1411/2011) Type 3W 8ohm A30C-560	DE4858309110
(2111) Type 3W 8ohm MSF-2D4SB53D	DE4858304920
Touch Button Block(1411/2011)	DE4854926901
(2111)	DE4854921101
Tuner Type TEKE4-005B(120A) for "CP 14/20/2111"	DE4859713230
TECC2889VA 15C for "CL 1411/2111"	DE4859713030
DT2-IV15P for "C1411/2011"	DE4859715130

REPLACEMENT PARTS LIST

PRODUCT SAFETY NOTE: Components marked with a \triangle have special characteristics important to safety. Before replacing any of these components, read carefully the PRODUCT SAFETY NOTICE of this service manual. Don't degrade the safety of this receiver through improper servicing.

Resistor Abbreviation	Type
CF	Carbon Film
MO	Metal Oxide Film
FF	Fusible Film
VR	Variable Control
WC	Wire COPPER
CM	CEMENT
CC	Carbon Compo

Capacitor Abbreviation	Type
C	Ceramic
M	Mylar
LA	Line Across
TA	Tantalum

Note: Components marked with ☆ - Please refer to the attached "Different Parts List"

Ref No.	Part No.	Value	Type	Wattage
R101	DERD-AZ101J-	100	CF	1/6
R102	DERD-AZ472J-	4K7	CF	1/6
R103	DERD-AZ122J-	1K2	CF	1/6
R104	DERD-AZ122J-	1K2	CF	1/6
R105	DERD-AZ101J-	100	CF	1/6
R106	DERD-AZ682J-	6K8	CF	1/6
R107	DERD-AZ333J-	33K	CF	1/6
☆ R108	DERD-AZ183J-	18K	CF	1/6(CL)
☆ R108	DE85801065GY		WC	-(C,CP)
R109	DERD-AZ562J-	5K6	CF	1/6
☆ R110	DERD-AZ185J-	1.8M	CF	1/6(CL)
R111	DERD-AZ304J	300K	CF	1/6
R112	DERD-AZ473J-	47K	CF	1/6
☆ R113	DERD-AZ471J-	470	CF	1/6(C,CP)
☆ R113	DERD-AZ221J-	220	CF	1/6(CL)
R114	DERD-4Z365J-	3M6	CF	-1/4
R301	DERD-4Z335J-	3M3	CF	1/4
R302	DERD-AZ244J-	240K	CF	1/6
R304	DERD-AZ183J-	18K	CF	1/6
R305	DERD-AZ392J-	3K9	CF	1/6
R306	DERD-4Z471J-	470	CF	1/4
R307	DERD-AZ104J-	100K	CF	1/6
R308	RS02Y181J-	180	MO	2
R309	DERD-AZ153J-	15K	CF	1/6
R310	DERD-AZ913J-	91K	CF	1/6
R311	DERD-AZ391J-	390	CF	1/6
R312	DERD-AZ223J-	22K	CF	1/6
R313	DERD-2Z229J-	2R2	CF	1/2
R314	DERD-AZ514J-	510K	CF	1/6
R315	DERD-4Z202J-	2K	CF	1/4
R316	DERD-4Z271J-	270	CF	1/4
R317	DERD-AZ103J-	10K	CF	1/6
R318	DERD-AZ430J-	43	CF	1/6
R401	RS02Z153J-	15K	MO	2
R402	RS02Z153J-	15K	MO	2
R403	DERD-AZ472J-	4K7	CF	1/6
R404	DERD-AZ151J-	150	CF	1/6
R405	DERD-AZ122J-	1.2K	CF	1/6
R406	DERD-AZ824J-	820K	CF	1/6
R407	DERD-AZ153J-	15K	CF	1/6
R408	DERD-4Z272J-	2K7	CF	1/4
R409	RS02Z512J-	5K1	MO	2
R410	DERS02Z512J-	5K1	MO	2

Ref No.	Part No.	Value	Type	Wattage
☆ R411	DERD-2Z164J-	180K	CF	1/2(14")
☆ R411	DERD-2Z124J-	120K	CF	1/2(20",21")
R412	DERD-4Z102J-	1K	CF	1/4
R413	DERS01Y103J-	10K	MO	1
R414	DERS02Y561J-	560	MO	2
R415	RS01Y109J-	1	MO	1
R416	DERD-2Z273J-	27K	CF	1/2
R417	DERD-AZ124J-	120K	CF	1/6
R418	DERD-AZ303J-	30K	CF	1/6
R419	DERD-AZ303J-	30K	CF	1/6
R420	RS01Y100J-	10	MO	1
☆ R421	Refer to "Different parts list"			
R421	DERF01Y629JA	6R2	FF	1 (20")
☆ R422	DERS02Y339J-	3R3	FF	2
☆ R423	Refer to "Different parts list"			
R501	DERD-AZ473J-	47K	CF	1/6
R502	DERD-AZ104J-	100K	CF	1/6
R503	DERD-AZ121J-	120	CF	1/6
R504	DERD-4Z109J-	1	CF	1/4
R505	DERD-AZ102J-	1K	CF	1/6
R506	DERD-AZ103J-	10K	CF	1/6
R507	DERD-4Z511J-	510	CF	1/4
R508	DERD-AZ103J-	10K	CF	1/6
R509	DERD-AZ750J-	75	CF	1/6
R510	DERD-AZ750J-	75	CF	1/6
R511	DERD-AZ750J-	75	CF	1/6
R512	DERD-4Z750J-	75	CF	1/4
R513	DERD-AZ103J-	10K	CF	1/6
R514	DERD-AZ202J-	2K	CF	1/6
R515	DERD-AZ202J-	2K	CF	1/6
R516	DERD-AZ202J-	2K	CF	1-6
R517	DERD-AZ102J-	1K	CF	1/6
R610	DERD-AZ103J	10K	CF	1/6
R602	DERD-AZ751J-	750	CF	1/6
R603	DERD-AZ222J-	2K2	CF	1/6
R605	85801065GY		WC	
R610	DERD-AZ561J-	560	CF	1/6
R611	DERD-AZ270J-	27	CF	1/6
R612	DERD-AZ562J-	5K6	CF	1/6
R613	DERD-AZ681J-	680	CF	1/6
R614	DERD-AZ391J-	390	CF	1/6
R620	DERD-AZ133J-	13K	CF	1/6
R621	DERD-AZ152J-	1K5	CF	1/6

PRODUCT SAFETY NOTE: Components marked with a \triangle have special characteristics important to safety. Before replacing any of these components, read carefully the PRODUCT SAFETY NOTICE of this service manual. Don't degrade the safety of this receiver through improper servicing.

Ref No.	Part No.	Value	Type	Wattage
R624	DERD-AZ153J-	15K	CF	1/6
R625	DERD-AZ153J-	15K	CF	1/6
R626	DERD-AZ153J-	15K	CF	1/6
R701	DERD-AZ102J-	1K	CF	1/6
R702	DERD-AZ331J-	330	CF	1/6
R703	DERD-AZ470J-	47	CF	1/6
R704	DERD-AZ101J-	100	CF	1/6
R705	DERD-AZ222J-	2K2	CF	1/6
R707	DERD-AZ102J-	1K	CF	1/6
R708	DERD-AZ121J-	120	CF	1/6
R709	DERD-AZ750J-	75	CF	1/6
R710	DERD-AZ750J-	75	CF	1/6
R711	DERD-AZ103J-	10K	CF	1/6
R712	DERD-4Z109J-	1	CF	1/4
R713	DERD-AZ272J-	2K7	CF	1/6
R715	DERD-AZ362J-	3K6	CF	1/6
R720	DERD-AZ472J-	4K7	CF	1/6
R721	DERD-AZ184J-	180K	CF	1/6
☆ R801	Refer to "Different parts list"			
R802	DERD-2Z154J-	150K	CF	1/2
☆ R803	DERD-2Z154J-	150K	CF	1/2
R804	DERF01Y688J-	0R68	FF	1
R805	DERD-4Z270J-	27	CF	1/4
R806	DERX05B360JE	36	CM	5
R807	DEDB59346P20		POSISTOR	
R808	DERS02Y912J-	9K1	MO	2
R810	DERS02Y912J-	9K1	MO	2
R809	DERD-4Z122J-	1K2	CF	1/4
R811	DERD-4Z153J-	15K	CF	1/4
R812	DERD4Z153J-	15K	CF	1/4
☆ R813	DERF02Y101J-	100	FF	2
R814	DERRC-2Z565J-	5.6M	CC	1/2
R815	DERC-2Z565J	5.6M	CC	1/2
R823	DERD01Y109J-	1	FF	1
R824	DERS01Y270J-	27	MO	2
R825	DERS02Y159J-	1K5	FF	2
R827	DERD-AZ103J-	10K	CF	1/6
R828	DERD-AZ473J-	47K	CF	1/6
R829	DERS01Y473J-	47K	MO	1
R830	DERD-4Z221J-	220	CF	1/4
R831	RX10B339JK	3R3	CM	10
R832	DERD-2Z154J-	150K	CF	1/2
R833	DERD-2Z124J-	120K	CF	1/2
RA01	DERD-AZ473J-	47K	CF	1/6
RA02	DERD-AZ103J-	10K	CF	1/6
RA03	DERD-AZ103J-	10K	CF	1/6
RA04	DERD-AZ223J-	22K	CF	1/6
RA05	DERD-AZ103J-	10K	CF	1/6
RA06	DERD-AZ473J-	47K	CF	1/6
RA07	DERD-AZ102J-	1K	CF	1/6
RA08	DERD-4Z109J-	1	CF	1/4
RA09	DERD-AZ824J-	820K	CF	1/6
RL01	DERD-AZ222J-	2K2	CF	1/6
RL02	DERD-AZ103J-	10K	CF	1/6
RL03	DERD-AZ103J-	10K	CF	1/6
RL04	DERD-AZ103J-	10K	CF	1/6
RL05	DERD-AZ223J-	22K	CF	1/6
RL06	DERD-AZ683J-	68K	CF	1/6
RL07	DERD-AZ302J-	3K	CF	1/6

Ref No.	Part No.	Value	Type	Wattage
RL08	DERD-AZ102J-	1K	CF	1/6
RL09	DERD-AZ102J-	1K	CF	1/6
RL10	DERD-AZ472J-	4K7	CF	1/6
RL11	DERD-AZ393J-	39K	CF	1/6
RL12	DERD-AZ104J-	100K	CF	1/6
RL13	DERD-AZ472J-	4K7	CF	1/6
RL14	DERD-AZ223J-	22K	CF	1/6
RL15	DERD-AZ393J-	39K	CF	1/6
RL17	DERD-AZ472J-	4K7	CF	1/6
RL24	DERD-AZ223J-	22K	CF	1/6
RL25	DERD-AZ433J-	43K	CF	1/6
RL26	DERD-AZ472J-	4K7	CF	1/6
RT01	DERD-AZ273J-	27K	CF	1/6
RT02	DERD-AZ431J-	430	CF	1/6
RT03	DERD-AZ431J-	430	CF	1/6
RT04	DERD-AZ431J-	430	CF	1/6
RT05	DERD-AZ750J-	75	CF	1/6
RT07	DERD-AZ221J-	220	CF	1/6
RT08	DERD-AZ221J-	220	CF	1/6
RT09	DERD-AZ472J-	4K7	CF	1/6
RT10	DERD-AZ472J-	470	CF	1/6
RT11	DERD-AZ221J-	220	CF	1/6
RT15	DERD-AZ103J-	10K	CF	1/6
RT16	DERD-AZ222J-	2K2	CF	1/6
RT17	DERD-AZ272J-	2K7	CF	1/6
RT18	DERD-AZ103J-	10K	CF	1/6
RT19	DERD-AZ182J-	1K8	CF	1/6
RT20	DERD-AZ103J-	10K	CF	1/6
RT23	DERD-AZ223J-	22K	CF	1/6
RT24	DERD-4Z109J-	1K	CF	1/6
RT25	DERD-4Z113J-	11K	CF	1/6
RT30	DERD-AZ391J-	390	CF	1/6
RT31	DERD-AZ751J-	750	CF	1/6
RT33	DERD-AZ750J-	75	CF	1/6
RV01	DERD-AZ333J-	33K	CF	1/6
RV02	DERD-AZ912J-	9K1	CF	1/6
RV03	DERD-4Z333J-	33K	CF	1/6
RV04	RS02Y562J-	5K6	CF	1/6
RV05	DERD-AZ333J-	33K	CF	1/6
RV06	DERD-AZ333J-	33K	CF	1/6
RV07	DERD-AZ333J-	33K	CF	1/6
RV08	DERD-AZ103J-	10K	CF	1/6
RV09	DERD-AZ272J-	2K7	CF	1/6
RV10	DERD-AZ102J-	1K	CF	1/6
RV11	DERD-AZ332J-	3K3	CF	1/6
RV12	DERD-AZ101J-	100	CF	1/6
RV13	DERD-AZ122J-	1K2	CF	1/6
RV14	DERD-AZ623J-	62K	CF	1/6
RV15	DERD-AZ472J-	4K7	CF	1/6
RV16	DERD-AZ472J-	4K7	CF	1/6
☆ RV17	DERD-AZ472J-	4K7	CF	1/6(20",21")
☆ RV17	DERD-AZ113J-	11K	CF	1/6(14")
RV18	DERD-AZ221J-	220	CF	1/6
RV19	DERD-AZ472J-	4K7	CF	1/6
RV20	DERD-AZ472J-	4K7	CF	1/6
RV21	DERD-AZ222J-	2K2	CF	1/6
RV22	DERD-AZ273J-	27K	CF	1/6
RV23	DERD-AZ473J-	47K	CF	1/6
RV24	DERD-AZ151J-	150	CF	1/6

PRODUCT SAFETY NOTE: Components marked with a \triangle have special characteristics important to safety. Before replacing any of these components, read carefully the PRODUCT SAFETY NOTICE of this service manual. Don't degrade the safety of this receiver through improper servicing.

Ref No.	Part No.	Value	Type	Wattage
RV25	DERD-AZ912J-	9K1	CF	1/6
RV26	DERD-AZ203J-	20K	CF	1/6
☆ RV27	DERD-AZ682J-	6K8	CF	1/6
RV28	DERD-AZ203J-	20K	CF	1/6
RV29	DERD-AZ472J-	4K7	CF	1/6
RV30	DERD-AZ472J-	4K7	CF	1/6
RV31	DERD-AZ472J-	4K7	CF	1/6
RV33	DERD-AZ473J-	47K	CF	1/6
RV32	DERD-AZ103J-	10K	CF	1/6
RV34	DERD-AZ391J-	390	CF	1/6
RV35	DERD-AZ473J-	47K	CF	1/6
RV36	DERD-AZ470J-	47	CF	1/6
RV37	DERD-AZ391J-	390	CF	1/6
RV38	DERD-AZ272J-	2K7	CF	1/6
RV39	DERD-AZ682J-	6K8	CF	1/6
RV40	DERD-AZ102J-	1K	CF	1/6
RV41	DERD-AZ750J-	75	CF	1/6
RV42	DERD-AZ102J-	1K	CF	1/6
RV43	DERD-AZ473J-	47K	CF	1/6
RV45	DERD-AZ101J-	100	CF	1/6
RV46	DERD-AZ101J-	100K	CF	1/6
RV47	DERD-AZ332J-	3K3	CF	1/6
RV48	DERD-AZ332J-	3K3	CF	1/6
RV49	DERD-AZ101J-	100	CF	1/6
RV50	DERD-AZ101J-	100	CF	1/6
RV51	DERD-AZ114J-	110K	CF	1/6
RV52	DERD-AZ331J-	330	CF	1/6
RV53	DERD-AZ662J-	6K2	CF	1/6
RV54	DERD-AZ102J-	1K	CF	1/6
RV55	DERD-AZ823J-	82K	CF	1/6
RV56	DERD-AZ102J-	1K	CF	1/6
RV57	DERD-AZ202J-	2K	CF	1/6
RV58	DERD-AZ562J-	5K6	CF	1/6
RV59	DERD-AZ103J-	10K	CF	1/6
RV60	DERD-AZ103J-	10K	CF	1/6
RV61	DERD-89X103J	10KX8	ARRAY	1/8
RV62	DERD-AZ103J-	10K	CF	1/6
RV63	DERD-AZ103J-	10K	CF	1/6
RV64	DERD-AZ102J-	1K	CF	1/6
RV65	DERD-AZ103J-	10K	CF	1/6
RV66	DERD-AZ103J-	10K	CF	1/6
RV67	DERD-AZ103J-	10K	CF	1/6
RV68	DERD-AZ103J-	10K	CF	1/6
RV70	DERD-AZ103J-	10K	CF	1/6
VR101	DERV5426103P	10K	VR	AGC ADJ.
VR301	DERV5426221P	220	VR	Vert.size
VR302	DERV6417103-	10K	VR	Vert.cent.
VR401	DERV5426103P	10K	VR	H.cent.
VR701	DERV5426473P	47K	VR	Sub.Brig.
VR801	DERV5426472P	4K7	VR	B* ADJ

PRODUCT SAFETY NOTE: Components marked with a \triangle have special characteristics important to safety. Before replacing any of these components, read carefully the PRODUCT SAFETY NOTICE of this service manual. Don't degrade the safety of this receiver through improper servicing.

Ref No.	Part No.	Value	Type	Voltage
C101	DECCXB1H102K	1000p	C	50
C102	DECCXF1H103Z	10n	C	50
C103	DECCXF1H103Z	10n	C	50
C104	DECEXF1C470V	47u	EL	16
C105	DECEXE1H100A	10u	EL	50
C106	DECMXM2A104J	100n	M	100
C107	DECEXE1H479A	4u7	EL	50
C108	DECCZF1E103Z	10n	C	25
C109	DECEXE1H479A	4u7	EL	50
C110	DECCZF1E103Z	10n	C	25
C111	DECEXE1H479A	4u7	EL	50
C111	DECEXF1C101V	100μ	EL	16
C112	DECCZF1E103Z	10n	C	25
C113	DECXCH1H100D	10p	C	50
C114	DECEXE1H479A	4u7	EL	50
C115	DECCXE1H223Z	22n	C	50
C116	DECBXF1H104Z	100n	C	50
C117	DECEXE1H109A	1u	EL	50
C118	DECCXF1H223Z	22n	C	50
C119	DECCXB1H472K	4700p	C	50
C120	DECBXF1H104Z	100n	C	50
C121	DECBXF1H104Z	100n	C	50
C122	DECCXF1H104Z	10n	C	50
C123	DECCXF1H103Z	10n	C	50
C301	DECMXB2A683J	68n	M	100
C302	DECCXB1H222K	2200p	C	50
C303	DECCXB1H102K	1000p	C	50
C304	DECEXE1H478A	OR47	EL	50
C305	DECCXB1H472K	4700p	C	50
C306	DECMXM2A103J	10n	M	100
C307	DECCXB1H471K	470p	C	50
C308	DECEXF1V101V	100u	EL	35
C309	DECEYF1V102V	1000u	EL	35
C310	DECMXM2A104J	100n	M	100
C311	DECEYF1V102V	1000u	EL	35
C312	DECEXE1H229A	2u2	EL	50
C401	DECCXF1H103Z	10n	C	50
C402	DECEXE1H479A	4u7	EL	50
C403	DECCXB1H222K	2200p	C	50
C404	DECCXB1H222K	2200p	C	50
C405	DECEXE1H109A	1u	EL	50
C406	DECXSL2H100D	10P	C	500
C407	DECCXB2H471K	470p	C	500
C408	DECCXB2H222K	2200p	C	500
☆ C409	Refer to "Different Parts List"			
☆ C410	Refer to "Different Parts List"			
☆ C411	Refer to "Different Parts List"			
C412	DECEXF2C339V	3u3	EL	160
C413	DECEYE2C330C	33u	EL	160
C414	DECEYE2C220C	22u	EL	160
C415	DECCXB2H102K	1000p	C	500
C416	DECEXF1E221V	220u	EL	25
C417	DECCYB2H472K	4700p	C	500
C418	DECXSL2H470J	47P	C	500
C419	DECCYB3A102K	1000p	C	1K
C420	DECMXM2A104J	100n	M	10
C421	DECCYB3A102K	1000p	C	1K
C422	DECEYF2E100V	10u	EL	250
C423	DECCXF1H103Z	10n	C	50

Ref No.	Part No.	Value	Type	Volage
C424	DECCXF1H103Z	10n	C	50
C425	DECCXF1H103Z	10n	C	50
C426	DECEXF1C101V	100u	EL	16
C427	DECEXF1C101V	100u	EL	16
C428	DECCXB1H181K	180p	C	50
C501	DECCXB1H180K	18p	C	50
C502	DECBXF1H104Z	100n	C	50
C503	DECCXB1H472K	4700p	C	50
C504	DECBXF1H104Z	100n	C	50
C505	DECBXF1H104Z	100n	C	50
C506	DECCXB1H102K	1000p	C	50
C507	DECCXB1H102K	1000p	C	50
C508	DECCXF1H223Z	22n	C	50
C509	DECCXF1H223Z	22n	C	50
C510	DECEXE1H479A	4u7	EL	50
C511	DECMXM2A104J	100n	M	100
C512	DECMXM2A224J	220n	M	100
C513	DECCXF1H103Z	10n	C	50
C514	DECEXF1C470V	47u	EL	16
C516	DECMXM2A104J	100n	M	100
C517	DECMXM2A104J	100n	M	100
C518	DECMXM2A104J	100n	M	100
C601	DECCXB1H392K	2900p	C	50
C603	DECEXD1E100F	10u	EL	25
C604	DECCXB1H102K	1000p	C	50
C605	DECCXB1H102K	1000p	C	50
C606	DECXCH1H560J	56P	C	50
C607	DEDXCH1H680J	68P	C	50
C608	DECCXB1H222K	2200p	C	50
C609	DECEXD1H229F	2u2	EL	50
C610	DECCXB1H221K	220p	C	50
C612	DECCXB1H102K	1000p	C	50
C613	DECCXB1H102K	1000p	C	50
C614	DECEXE1H479A	4u7	EL	50
C615	DECCXB1H181K	180p	C	50
C616	DECEXE1H229A	2u2	EL	50
C617	DECCXB1H102K	1000	C	50
C619	DECCXF1H223Z	22n	C	50
C620	DECEXF1E221V	220u	EL	16
C621	DECCXF1H393J	39n	C	50
C622	DECCXB1H181K	180p	C	50
C623	DECCXB1H181K	180p	C	50
C701	DECBXF1H104Z	100n	C	50
C702	DECBXF1H104Z	100n	C	50
C703	DECCXF1H223Z	22n	C	50
C704	DECEXF1C331V	330u	EL	16
C705	DECCXF1H473Z	47n	C	50
C711	DECEXE1H100A	10u	EL	50
C716	DECMXM2A473J	47n	M	100
C801	DECL1JB3474M	470n	LA	AC250
C802	DECL1JB3474M	470n	LA	AC250
C803	DECCYF3A472Z	4700p	C	1K
C804	DECCYF3A472Z	4700p	C	1K
C805	DECCYF3A472Z	4700p	C	1K
C806	DECCYF3A472Z	4700p	C	1K
C807	DECEYM2G121T	120u	EL	400
C808	DECMZM2A272J	2700P	M	100(14")
☆ C808	DECMZM2A392J	3900P	M	100(20,21")
C809	DECMYH3C152J	1500P	M	1K6



PRODUCT SAFETY NOTE: Components marked with a  have special characteristics important to safety. Before replacing any of these components, read carefully the PRODUCT SAFETY NOTICE of this service manual. Don't degrade the safety of this receiver through improper servicing.





Ref No.	Part No.	Value	Type	Volage
C811	DECEXF1C101V	100u	EL	16
C812	DECEXF1C471V	470u	EL	16
C813	DECCXB1H101K	100P	C	50
C814	DECEXE1H109A	1u	EL	50
C815	DECMYM2D682K	6800P	M	200
C816	DECEXF1C101V	100u	EL	16
C817	DECEXE1E331A	330u	EL	25
C819	DECEXE1H109A	1u	EL	50
C820	DECH1FFF103M	10n	C	AC250
C821	DECH1FFF103M	10n	C	AC250
C822	DECEYF2C101C	100u	EL	160
C823	DECEYF2C101C	100u	EL	160
C827	DECCXB2H102K	1000P	C	500
C828	DECEXF1E102C	1000u	EL	25
C830	DECCYR3A102K	1000P	C	1K
C831	DECEXF1E471C	470u	EL	25
C832	DECCYR3A152K	1500P	C	1K
C833	DECEXF1H100V	10u	EL	50
CA01	DECEXE1H100A	10u	EL	50
CL01	DECXCH1H100J	10p	C	50
CL02	DECCXF1H103Z	10n	C	50
CL03	DECEXE1C330A	33u	EL	16
CL04	DECEXE1H479A	4u7	EL	50
CL05	DECEXE1H479A	4u7	EL	50
CL06	DECEXE1H109A	1u	EL	50
CL07	DECCXB1H222K	2200P	C	50
CL08	DECXCH1H100D	10P	C	50
CL09	DE4850L00200	30P	TRIMMER	
CL12	DECEXD1E100F	10u	EL	25
CT01	DECBXB1H104Z	100n	C	50
CT02	DECEXF1C101V	100u	EL	16
CT03	DECCXB1H102K	1000P	C	50
CT04	DECXCH1H150J	15P	C	50
CT05	DECXCH1H560J	56P	C	50
CT06	DECMXM2A104J	100n	M	100
CT07	DECMXM2A104J	100n	M	100
CT08	DECEXE1H100A	10u	EL	50
CT09	DECEXE1H100A	10u	EL	50
CT11	DECEXF1C101V	100u	EL	16
CT12	DECBXF1H104Z	100n	C	50
CT14	DECBXF1H104Z	100n	C	50
CT15	DECCXB1H101K	100P	C	50
CT16	DECBXF1H104Z	100n	C	50
CT17	DECEXE1H100A	10u	EL	50
CU01	DECCZB1H102K	1000P	C	50
CU02	DECCZB1H102K	1000P	C	50
CU03	DECCZB1H101K	100P	C	50
CU04	DECCZB1H101K	100P	C	50
CV01	DECTXD1V228K	220n	TA	35
CV02	DECEXF1H470V	47u	EL	50
CV03	DECCXF1H103Z	10n	C	50
CV04	DECMXM2A104J	10n	M	100
CV05	DECMXM2A104J	10n	M	100
CV06	DECCXB1H181K	180P	C	50
CV07	DECEXF1H220V	22u	EL	50
CV08	DECEXE1H479A	4u7	EL	50
CV09	DECEXF1H220V	22u	EL	50
CV10	DECEXE1H479A	4u7	EL	50
CV11	DECEXE1H479A	4u7	EL	50





Ref No.	Part No.	Value	Type	Volage
CV12	DECEXE1H109A	1u	EL	50
CV13	DECEXE1H100A	10u	EL	50
CV14	DECXCH1H270J	27p	C	50
CV15	DECXCH1H150J	15p	C	50
CV16	DECEXE1C330A	33u	EL	16
CV17	DECEXE1C561A	560p	C	50
CV18	DECEXE1H100A	10u	EL	50
CV19	DECEXF1C470V	47u	EL	16
CV21	DECCXB1H222K	2200p	C	50
CV22	DECXCH1H220J	22p	C	50
CV23	DECXCH1H220J	22p	C	50
CV24	DECCXB1H331K	330p	C	50
CV27	DECEXF1H100A	10u	EL	50
CV28	DECEXF1H220V	22u	EL	50
CV30	DECCXB1H151K	150p	C	50
CV31	DECCZB1H151K	150p	C	50
CV32	DECCZB1H151K	150pP	C	50
CV33	DECEXE1H229A	2u2	EL	50

PRODUCT SAFETY NOTE: Components marked with a  have special characteristics important to safety. Before replacing any of these components, read carefully the PRODUCT SAFETY NOTICE of this service manual. Don't degrade the safety of this receiver through improper servicing.

Ref No.	Part No.	Description
I301	DE1TDA3653B-	TDA3653B
I401	DE1KA7808---	KA7808
I402	DE1L7812CV--	L7812CV
I501	DEITDA4665--	TDA4665
I502	DE1TDA8395--	TDA8395
I601	DEITDA7056--	TDA7056
I701	DE1TDA8362--	TDA8362
I701	DE1TDA8362B--	TDA8362B
I801	DE1TDA4601--	TDA4601
I802	DE1L7805CV--	L7805CV
IA01	DE1TC4053BP	TC4053BP
IL01	DE1TDA3843--	TDA3843
IV01	DE1DW167MN04	DW-167MN04
IV02	DE124LC08B--	24LC08B
IV03	DE1K1A7042P-	KIA7042P
IV04	DE1UPC574J--	UPC574J
Q101	DETKTC3197--	KTC3197
Q401	DETKTC3207--	KTC3207
 Q402	DETKSD5072UT	KSD5072-TU
Q501	DETKTC3198Y-	KTC3198Y
Q502	DETKTC3198Y-	KTC3198Y
Q503	DETKTC3198Y-	KTC3198Y
Q601	DETKTC3198Y-	KTC3198Y
Q602	DETKTC3198Y-	KTC3198Y
Q603	DETKTC3197--	KTC3197
Q701	DETKTC3198Y-	KTC3198Y
Q702	DETKTC3198Y-	KTC3198Y
 Q801	DETKSD5072TU	KSD5072-TU
Q805	DETKTC3198Y-	KTC3198Y
Q806	DETKTC3198Y-	KTC3198Y
QA01	DETKTC3198Y-	KTC3198Y
QA02	DEATA1266Y-	KTA1266Y
QA03	DETKTC3198Y-	KTC3198Y
QL01	DETKTC3198Y-	KTC3198Y
QL02	DETKTC3198Y-	KTC3198Y
QL03	DETKTC3198Y-	KTC3198Y
QL04	DETKTC3198Y-	KTC3198Y
QL05	DETKTC3198Y-	KTC3198Y
QL06	DETKTA1266Y-	KTA1266Y
QN01	DETKTC3198Y-	KTC3198Y
QT01	DETKTC3198Y-	KTC3198Y
QT05	DETKTA1266Y-	KTC3198Y
QT07	DETKTA1266Y-	KTA1266Y
QT08	DETKTC3198Y-	KTC3198Y
QV01	DETKTC3202Y-	KTC3202Y
QV02	DETKTC3202Y-	KTC3202Y
QV03	DETKTA1266Y-	KTA1266Y
QV04	DETKTA1266Y-	KTA1266Y
QV05	DETKTA1266Y-	KTA1266Y
QV06	DETKTC3198Y-	KTC3198Y
QV07	DETKTC3198Y-	KTC3198Y
QV08	DETKTC3198Y-	KTC3198Y
QV09	DETKTC3198Y-	KTC3198Y
QV11	DETKTC3198Y-	KTC3198Y
QV13	DETKTA1266Y-	KTA1266Y
QV14	TKTC3198Y-	KTC3198Y
QV15	TKTC3198Y-	KTC3198Y
QV16	DETKTC3198Y-	KTC3198Y
QV17	DETKTA1266Y-	KTA1266Y

Ref No.	Part No.	Description
QV18	DETKTC3198Y-	KTC3198Y
D302	DEDBYV95C---	BYV95C
D401	DEDUZ8R2BM--	UZ-8.2BM
D402	DEDBYW95C---	BYW95C
D403	DEDBYV95C---	BYV95C
D404	DEDBYV95C---	BYV95C
D405	DEDBYV95C---	DYV95C
D406	DEDBYV95C---	DBY95C
D407	DEDUZ5R1BM--	UZ-5.1BM
D408	DEDIN4148---	1N4148
D409	DEDIN4148---	1N4148
D501	DEDIN4148---	1N4148
D503	DEDUZ6R2BM--	UZ-6.2BM
D504	DEDUZ6R2BM--	UZ-6.2BM
D505	DEDUZ6R2BM--	UZ-6.2BM
D506	DEDUZ6R2BM--	UZ-6.2BM
D507	DEDUZ5R6BM--	UZ-5.6BM
D603	DEDUZ6R2BM--	UZ-6.2BM
D701	DEDIN4148---	1N4148
D702	DEDIN4148---	1N4148
D703	DEDIN4148---	1N4148
D704	DEDUZ6R2BM--	UZ-6.2BM
D705	DEDUZ6R2BM--	UZ-6.2BM
D706	DEDUZ5R6BM--	UZ-5.6BM
D707	DEDIN4148---	1N4148
D801	DEDPBS408GU-	PBS408GU-CA
D803	DEDIN4002---	1N4002
D804	DEDBYV95C---	BYV95C
D805	DEDBYV95C---	BYV95C
D807	DEDBYV95C---	BYV95C
D809	DEDBYW95C---	BYW95C
D810	DEDBYV95C---	BYV95C
D811	DEDBYV95C---	BYV95C
D812	DEDIN4148---	1N4148
DA01	DEDIN4148---	1N4148
DL01	DEDIS2186---	IS2186
DL02	DEDIS2186---	IS2186
DL03	DEDIN4148---	1N4148
DL04	DEDIS2186---	IS2186
DL05	DEDIN4148---	1N4148
DL06	DEDIN4148---	1N4148
DL08	DEDIN4148---	1N4148
DT01	DEDIN4148---	1N4148
DT02	DEDIN4148---	1N4148
DT03	DEDIN4148---	1N4148
DT05	DEDIN4148---	1N4148
DT06	DEDIN4148---	1N4148
DV02	DEDIN4148---	1N4148
DV06	DEDIN4148---	1N4148
DV08	DEDIN4148---	1N4148
DV09	DEDIN4148---	1N4148
DV12	DEDIN4148---	1N4148
DV13	DEDIN4148---	1N4148
DV14	DEDIN4148---	1N4148
DV15	DEDIN4148---	1N4148
DV17	DEDIN4148---	1N4148
DV18	DEDUZ5R6BM--	UZ-5.6BM
 F801	DE5FSCB4022R	SEMKO F4AH 4A 250V MF51
L101	DE58C9780027	TRF-1201B

PRODUCT SAFETY NOTE: Components marked with a  have special characteristics important to safety. Before replacing any of these components, read carefully the PRODUCT SAFETY NOTICE of this service manual. Don't degrade the safety of this receiver through improper servicing.

Ref No.	Part No.	Description
L102	DE5CPZ470K02	47UH
L103	DE58B38R9061	TRF-1444P
L104	DE58C100J091	10uH
L301	DE58C100J091	10uH
L302	DE58C101J091	10uH
L401	DE5CPZ109M02	1UH
L402	DE5MC0000100	MD-5
L403	Refer to the "Different parts List"	
L404	DE58C9430599	94MH
L405	Refer to the "Different parts List"	
L406	DE5MC0000100	MD-5
L601	DE5CPZ829K02	8.2UH
L602	DE58C100J091	10MH
L603	DE58C100J091	10MH
L604	DE58C9430599	94MH
L605	DE5MC0000100	MD-5
L606	DE5MC0000100	MD-5
L701	DE5CPZ569K02	5.6UH
L702	DE58C100J091	10MH
 L801	DE5PLF3544B-	LF-3544B
L802	DE585801065GY	
L803	DE5CPZ109M02	1UH
L807	DE58C9430599	94MH
LL01	DE5CPZ100K02	10UH
LL02	DE5CPZ100K02	10UH
LT01	DE5CPZ109K02	1UH
LV01	DE5CPZ390K02	39UH
LV02	DE5CPZ479K02	4.7UH
LV03	DE5CPZ479K02	4.7UH
LV04	DE5CPZ479K02	4.7UH
S801	DE5SC0101328	SDT-SS-112DM
SF101	DE5PK2950M--	K2950M
SF101	DE5PG1900M--	G1966M
SF101	DE5PJ1951M--	J1951M
 T401	DE50D0000022	HD-15D
 T402	Refer to the "Different parts list"	
 T801	DE50M0000084	TSM-4020
VT101	DE4859713230	TEKE4-005B(120A)-(CP)
VT101	DE4859713030	TECC2889VA15C-(CL)
VT101	DE4859715130	DT2-IV15C-(C)
X501	DE5XE4R4336E	4.433619MHZ 30PPM
XN01	DE5XE3R5795E	3.5795MHZ 30PPM
XV01	DE5XE6R0000C	6.0000MHZ 20PPM
XT01	DE5XE27R000E	27.0MHz 30PPM
Z601	DE5PSFE55MB-	SFE 5.5MB-(CP, CL)
Z601	DE5PSFE60MB-	SFE 6.0MB-(C)
Z701	DE5PTPS55MB-	TPS5.5MB-(CP, CL)
Z701	DE5PTPS60MB-	TPS 6.0MB-(C)

■ CRT PCB PARTS LIST

Ref No.	Part No.	Value	Type	Wattage
R501	DERS02Y912J-	9K1	MO	2(14")
R501	DERS02Y123J-	12K	MO	2(20",21")
R502	DERV5221103-	10K	VR	Blue Bias
R503	DERD-AZ152J-	1K5	CF	1/6
R504	DERD-AZ241J-	240	CF	1/6
R505	DERV5221201-	200	VR	Blue Drive
R506	DERC-2Z332J-	3K3	CF	1/2
R507	DERD-AZ560J-	56	CF	1/6
R508	DERD-AZ471J-	470	CF	1/6
R509	DERD-AZ101J-	100	CF	1/6
R511	DERS02Y912J-	9K1	MO	2(14")
R511	DERS02Y123J-	12K	MO	2
R512	DERV5221103-	10K	VR	Green Bias
R513	DERD-AZ152J-	1K5	CF	1/6
R514	DERD-AZ241J-	240	CF	1/6
R515	DERV5221201-	200	VR	Green Drive
R516	DERC-2Z332J-	3K3	CF	1/2
R517	DERD-AZ560J-	56	CF	1/6
R518	DERD-AZ471J-	470	CF	1/6
R519	DERD-AZ101J-	100	CF	1/6
R521	DERS02Y912J-	12K	MO	2(14")
R521	DERS02Y123J-	9K1	MO	2
R522	DERV5221103-	10K	VR	Red Bias
R523	DERD-AZ152J-	1K5	CF	1/6
R524	DERD-AZ241J-	120	CF	1/6
R525	DERD-AZ121J-	120	CF	1/6
R525	DERD-AZ221J-	220	CF	1/6
R526	DERC-2Z332J-	3K3	CF	1/2
R527	DERD-AZ560J-	56	CF	1/6
R528	DERD-AZ471J-	470	CF	1/6
R541	DERD-AZ621J-	620	CF	1/6
R542	DERD-AZ472J-	4K7	CF	1/6
R543	DERD-AZ472J-	4K7	CF	1/6
R544	DERD-AZ472J-	4K7	CF	1/6
R550	DERD-AZ103J-	10K	CF	1/6
R551	DERD-AZ103J-	10K	CF	1/6
R552	DERD-AZ103J-	10K	CF	1/6

Ref No.	Part No.	Value	Type	Voltage
C501	DECXCH1H221J	220p	C	50
C503	DECCXB1H271K	270p	C	50(14")
C503	DECCXB1H331K	330P	C	50(20",21")
C511	DECXCH1H221J	220p	C	50
C513	DECCXB1H271K	270p	C	50(14")
C513	DECCXB1H391K	390P	C	50(20",21")
C521	DECXCH1H221J	220p	C	50
C523	DECCXB1H271K	270p	C	50(14")
C523	DECCXB1H391K	390P	C	50(20",21")
C541	DECEXF1C101V	100u	EL	16
C542	DECCYE3D103P	10n	C	2K
C543	DECEY2E479C	4u7	EL	250

PRODUCT SAFETY NOTE: Components marked with a  have special characteristics important to safety. Before replacing any of these components, read carefully the PRODUCT SAFETY NOTICE of this service manual. Don't degrade the safety of this receiver through improper servicing.

Ref No.	Part No.	Description
Q501	DETKTC3207--	KTC3207
Q502	DETKTA1266Y-	KTA1266Y
Q511	DETKTC3207--	KTC3207
Q512	DETKTA1266Y-	KTA1266Y
Q521	DETKTC3207--	KTC3207
Q522	DETKTA1266Y-	KTA1266Y
D502	DEDUZ12R0BM-	UZ-12.0 BM
D512	DEDUZ12R0BM-	UZ-12.0 BM
D522	DEDUZ12R0BM-	UZ-12.0 BM

■ DEFFERENT PARTS FOR SYSTEM (1)

No	Loc.	PAL - B/G	P/S - B/G, S - L/L	PAL - I	REMARK
1	VT101 TECC2889VA15C	TEKE4-005B(120A)	TECC2889VA15C	DT2-1V15P	
2	SF101	G1966M	←	J1951M	
3	Z701	TPS5.5MB	←	TPS6.0MB	
4	Z601	SFE5.5MB	←	SFE6.0MB	
5	I502	x	TDA8395	x	
6	I701	TDA8362B	TDA8362	TDA8362B	
7	R108	JUMPER	18K	JUMPER	
8	R110	x	1.8M	x	
9	R113	470	220 470		
10	C105	10u	33u 10u		
11	C107	4.7u	←	x	
12	C108	0.01	←	x	
13	C109	4.7u	←	x	
14	C110	0.01	←	x	
15	C111	4.7u	←	100u	
16	P801A	CW4232	CW4232	CW3222	
17	LA01	x	MC4053	x	
18	QA01	x	KTC3198Y	x	
19	QA02	x	KTA1266Y	x	
20	QA03	x	KTC3198Y	x	
21	DA01	x	1N4148	x	
22	RA01	x	47K	x	
23	RA02	x	10K	x	
24	RA03	x	10K	x	
25	RA04	x	22K	x	
26	RA05	x	10K	x	
27	RA06	x	47K	x	
28	RA07	x	1K	x	
29	RA08	x	1(1/4W)	x	
30	RA09	x	820K	x	
31	CA01	x	10u	x	
32	IL01	x	TDA3843	x	
33	QL01	x	KTC3198Y	x	
34	QL02	x	KTC3198Y	x	
35	QL03	x	KTC3198Y	x	
36	QL04	x	KTC3198Y	x	
37	QL05	x	KTC3198Y	x	
38	QL06	x	KTA1266Y	x	
39	DL01	x	1S2186	x	
40	DL02	x	1S2186	x	
41	DL03	x	1N4148	x	
42	DL04	x	1S2186	x	
43	DL05	x	1N4148	x	
44	DL06	x	1N4148	x	
45	DL07	x	1N4148	x	
46	DL08	x	1N4148	x	

No	Loc.	PAL - B/G	P/S - B/G, S - L/L	PAL - I	REMARK
47	LL01	x	10uH	x	
48	LL02	x	10uH	x	
49	RL01	x	2.2K	x	
50	RL02	x	10K	x	
51	RL03	x	10K	x	
52	RL04	x	10K	x	
53	RL05	x	22K	x	
54	RL06	x	68K	x	
55	RL07	x	3K	x	
56	RL08	x	1K	x	
57	RL09	x	1K	x	
58	RL10	x	4.7K	x	
59	RL11	x	39K	x	
60	RL12	x	100K	x	
61	RL13	x	4.7K	x	
62	RL14	x	22K	x	
63	RL15	x	39K	x	
64	RL17	x	4.7K	x	
65	RL24	x	22K	x	
66	RL25	x	43K	x	
67	CL01	x	0.01	x	
68	CL02	x	0.01	x	
69	CL03	x	33u	x	
70	CL04	x	4.7u	x	
71	CL05	x	4.7u	x	
72	CL06	x	1u	x	
73	CL07	x	2200p	x	
74	CL08	x	10p	x	
75	CL09	x	TZ03R300B	x	
76	CL12	x	10u	x	
77	SL01	x	L9461M	x	
78	JL01	x	JUMPER	x	
79	QV03	KTA 226Y	←	x	
80	QV04	KTA 266Y	←	x	
81	DV08	x	←	1N4148	UHF only
82	DV09	x	1N4148	x	NO TEXT
83	DV12	x	1N4148	x	SECAM-L
84	DV13	1N4148	x	←	LIST
85	RV29	4.7K	←	x	
86	RV30	4.7K	←	x	
87	JB01	JUMPER	x	JUMPER	
88	JB02	JUMPER	x	JUMPER	

■ DIFFERENT PARTS FOR SYSTEM (2)

No	Loc	14 inch			20 inch			21 inch		
		ORION	PHILIPS	POLKOLOR	ORION	SAMSUNG	POLKOLOR	ORION	PHILIPS	POLKOLOR
1	CRT	A34JLL90X	A34EAC01X	A33EFU13X	A48JLL90X	A48ECR31X	A48EEV33X	A51JSW90X	A51EAL55X	A51EBV13X
2	CRT Socket	ISM01	←	ISH-04	ISM-03	←	OSH-04	ISM-03	←	ISH-04
3	D/COIL	DC-1450	←	←	DC-2050	←	←	DC-2070	←	←
4	T402	1142, 5037	1142, 5034	1142, 5025	1142, 5037	FSA17013M	1142, 5056	DCF-2217L	FSA17013M	←
5	L403	L-125	L-76	←	←	L-62	L-76	L-102	L-76	←
6	L405	AZ9004Y	←	←	JUMPER	←	←	←	←	←
7	R423	2W 56	←	←	JUMPER	←	←	←	←	←
8	R411	1/2W 180K	←	←	1/2W 120K	←	←	←	←	←
9	R421	2W 2.4	1W 2.2	1W 0.68	2W 2.4	2W 2.7	1W 1.0	1W 6.2	1W 6.8	2W 2.4
10	R501	2W 9.1K	←	←	2W 12K	←	←	←	←	←
11	R501	2W 9.1K	←	←	2W 12K	←	←	←	←	←
12	R501	2W 9.1K	←	←	2W 12K	←	←	←	←	←
13	RV09	2.2K	←	←	2.7K	←	←	←	←	←
14	RV17	11K	←	←	4.7K	←	←	←	←	←
15	C409	1.6KV 6000	1.6KV 6200	1.6KV 6000	1.6KV 7500	1.6KV 8200		1.6KV 7500	1.6KV 8200	1.6KV 7500
16	C410	2KV 470	x	2KV 220	x	2KV 1000	x	2KV 680	2KV 470	x
17	C411	200V 0.33	200V 0.51	←	←	←	←	200V 0.36	200V 0.47	←
18	R801	ERP-Z5B5N 180A	←	←	ECPAC 180M270	←	←	D262BF 140M 270	←	←

■ EXPLODED VIEW

■ 1411

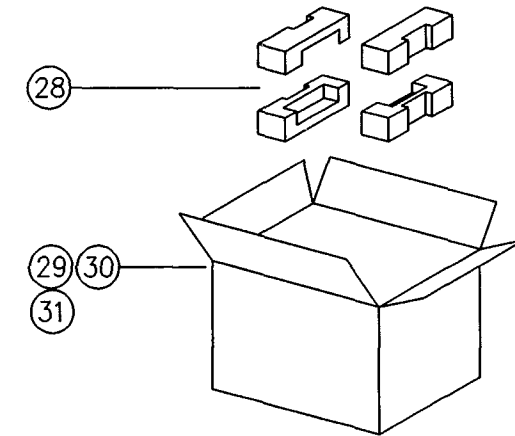
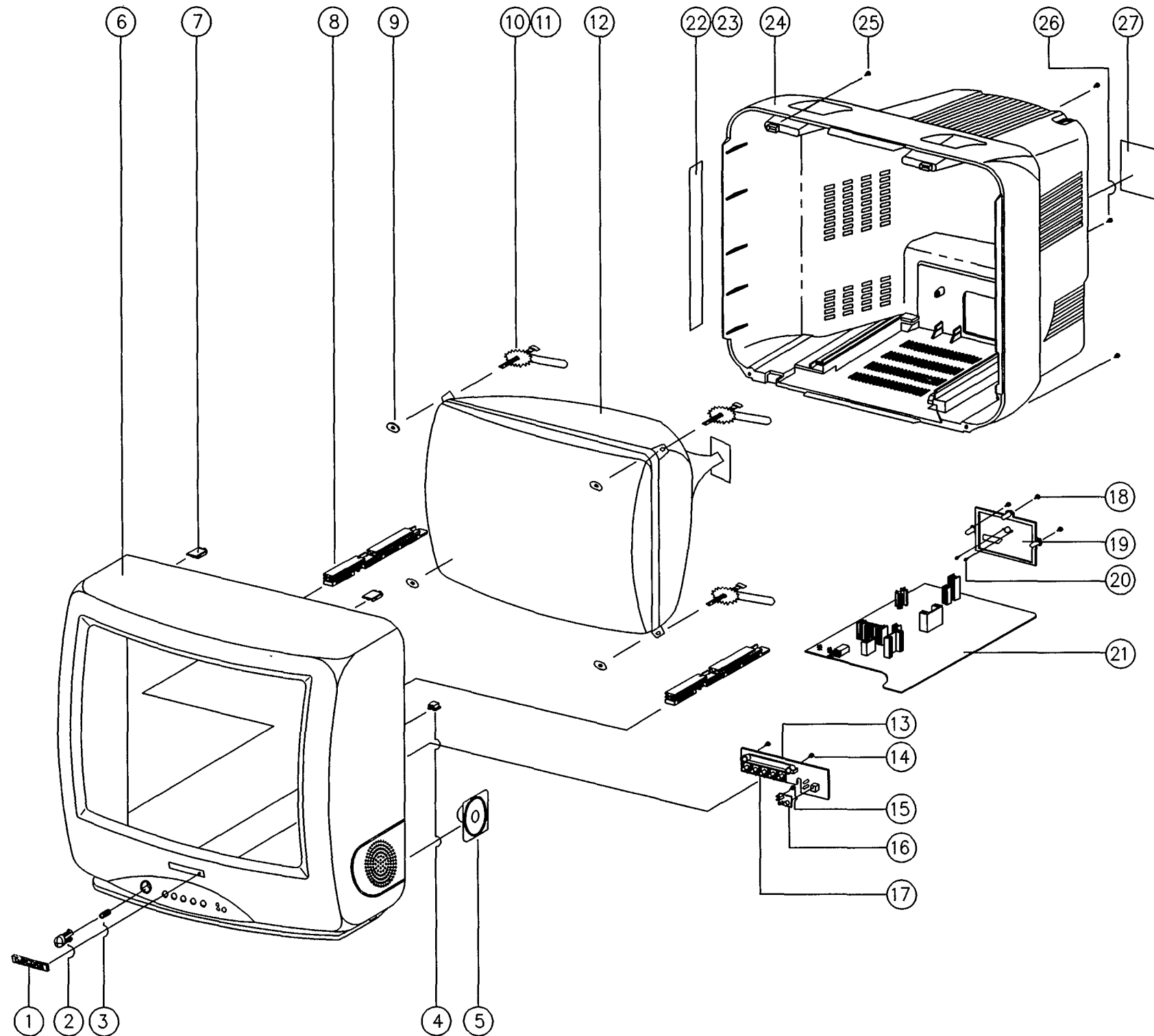

NO.	PART-CODE	PART-NAME	Q'TY	DESCRIPTION	REMARK
1	4855613600	MARK BRAND	1	COPPER T0 4	
2	4854843301	BUTTON POWER	1	ABS BK	
3	4856717900	SPRING	1	SWPA	
4	4853525500	HOLDER CORD	1	FR HIPS BK	
5	4858309110	SPEAKER	1	3W 8 OHM A30C-560	
6	4852053801	MASK FRONT	1	HIPS BK	
7	4853311601	RETAINER BACK	2	HIPS NC	
8	4853744401	RETA PCB	2	ABS BK	
9	4856215402	WASHER RUBBER	4	CR	
10	4856013300	SCREW CRT FIXING	2	L=70MM	
11	4856013301	SCREW CRT FIXING	2	L=140MM	
12		CRT	1		
13		PCB CONTROL AS	1	CP-330	
14	7128301011	SCREW TAPPING	2	T2S WAS 3X10 MFZN	CTRL PCB+MF
15	7128301011	SCREW TAPPING	1	T2S WAS 3X10 MFZN	D/SENSOR+MF
16	485524801	DECO SENSOR	1	PMMA CL	
17	4854926901	BUTTON	1	ABS BK	
18	7122401411	SCREW TAPPING	3	T2S TRS 4X14 MFZN	C/B+TERM
19	4853624803	TERM ANT	1	HIPS BK	
20	7121261011	SCREW TAPPING	2	T2S PAN 2 6X10 MFZN	TERM+J/AV
21		MAIN PCB AS	1	CP-330	
22	4857817611	CLOTH BLACK	2	FELT T0 7 L=200	
23	4857817620	CLOTH BLACK	1	FELT T0 5 L=100	
24	4852140600	COVER BACK	1	FR HIPS BK	
25	7122401411	SCREW TAPPING	4	T2S TRS 4X14 MFZN	C/B+MF
26	7122401411	SCREW TAPPING	1	T2S TRS 4X14 MFZN	C/B+FBT
27	4855415800	SPEC PLATE	1	150ART P/E FILM	
28	4858173400	PAD	1	EPS	
29	4858024900	BOX CARTON	1	SW-2	
30	6520010100	STAPLE PIN	12	18MM JDO	
31	4858210702	BAG P E	0 001	PE FILM T0 05X1150X1000	

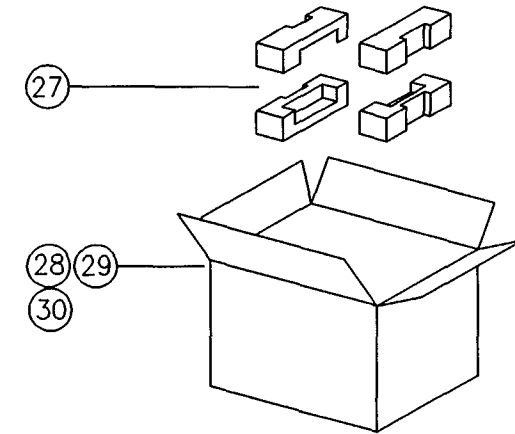
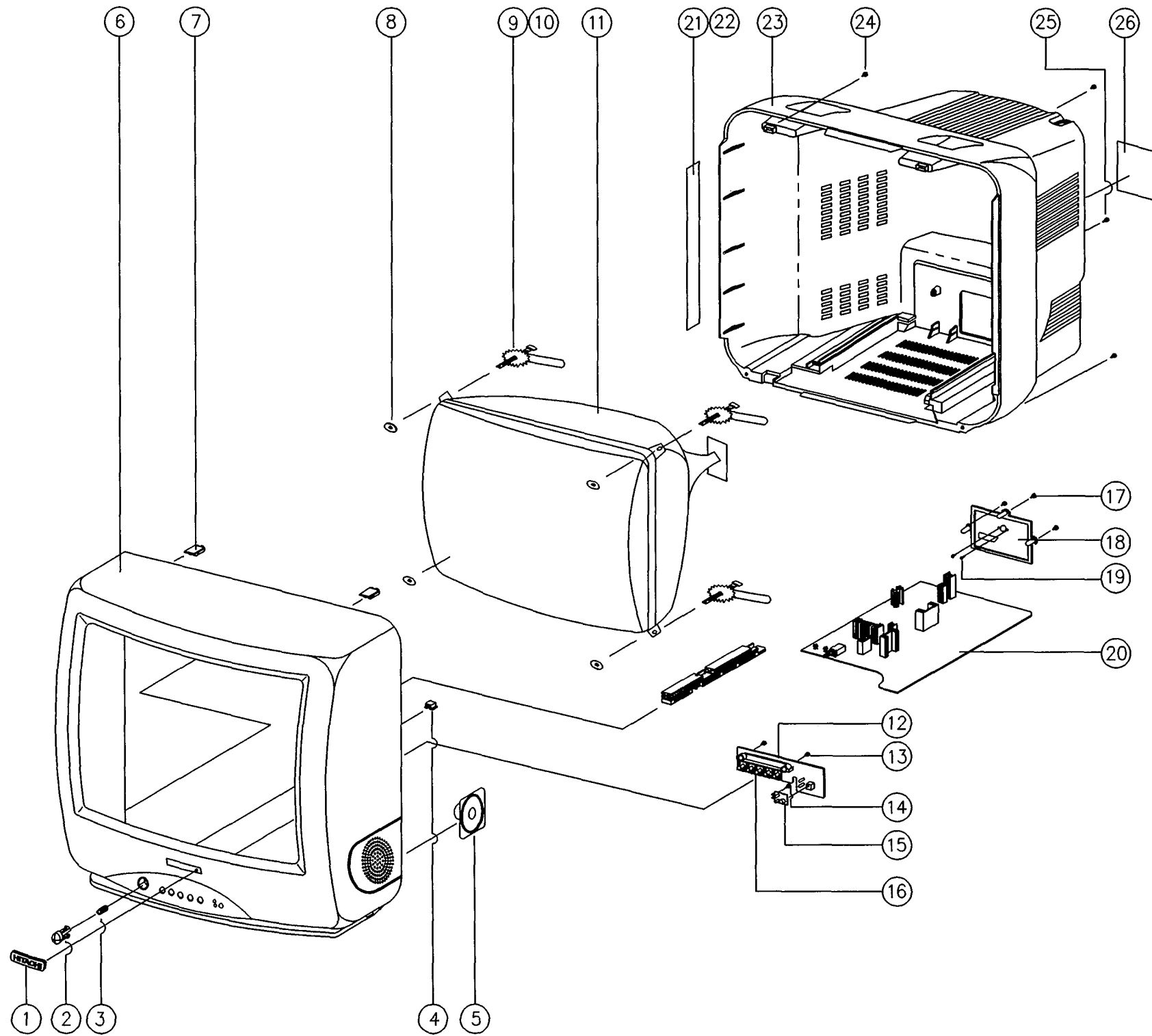

NO.	PART-CODE	PART-NAME	Q'TY	DESCRIPTION	REMARK
1	4855613600	MARK BRAND	1	COPPER TO 4	
2	4854843201	BUTTON POWER	1	ABS BK	
3	4856717900	SPRING	1	SWPA	
4	4853525500	HOLDER CORD	1	FR HIPS BK	
5	4858309110	SPEAKER	1	3W 8 OHM A30C-560	
6	4852053701	MASK FRONT	1	HIPS BK	
7	4853311601	RETAINER BACK	2	HIPS NC	
8	4856215402	WASHER RUBBER	4	CR	
9	4856013300	SCREW CRT FIXING	2	L=80M/M	
10	4856013302	SCREW CRT FIXING	2	L=190M/M	
11		CRT	1		
12		PCB CONTROL AS	1	CP-330	
13	7128301011	SCREW TAPPING	2	T2S WAS 3X10 MFZN	CTRL PCB+MF
14	7128301011	SCREW TAPPING	1	T2S WAS 3X10 MFZN	D/SENSOR+MF
15	4855524701	DECO SENSOR	1	PMMA CL	
16	4854926901	BUTTON	1	ABS BK	
17	7122401411	SCREW TAPPING	3	T2S TRS 4X14 MFZN	C/B+TERM
18	4851611900	TERM ANT ASSY	1	CP330-01+SPC+3C-2WS=150	
19	7121261011	SCREW TAPPING	2	T2S PAN 2 6X10 MFZN	TERM+J/AV
20		MAIN PCB AS	1	CP-330	
21	4857817610	CLOTH BLACK	2	FELT TO 7 L=300	
22	4857817611	CLOTH BLACK	1	FELT TO 5 L=200	
23	4852140500	COVER BACK	1	FR HIPS BK	
24	7122401411	SCREW TAPPING	4	T2S TRS 4X14 MFZN	C/B+M/F
25	7122401411	SCREW TAPPING	1	T2S TRS 4X14 MFZN	C/B+FBT
26	4855415800	SPEC PLATE	1	150ART P/E FILM	
27	4858173300	PAD	1	EPS	
28	4858033700	BOX CARTON	1	DW-3	
29	6520010100	STAPLE PIN	12	18M/M JDO	
30	4858261300	BAG P E	0 001	T0 02X1200X1000	C/TV20

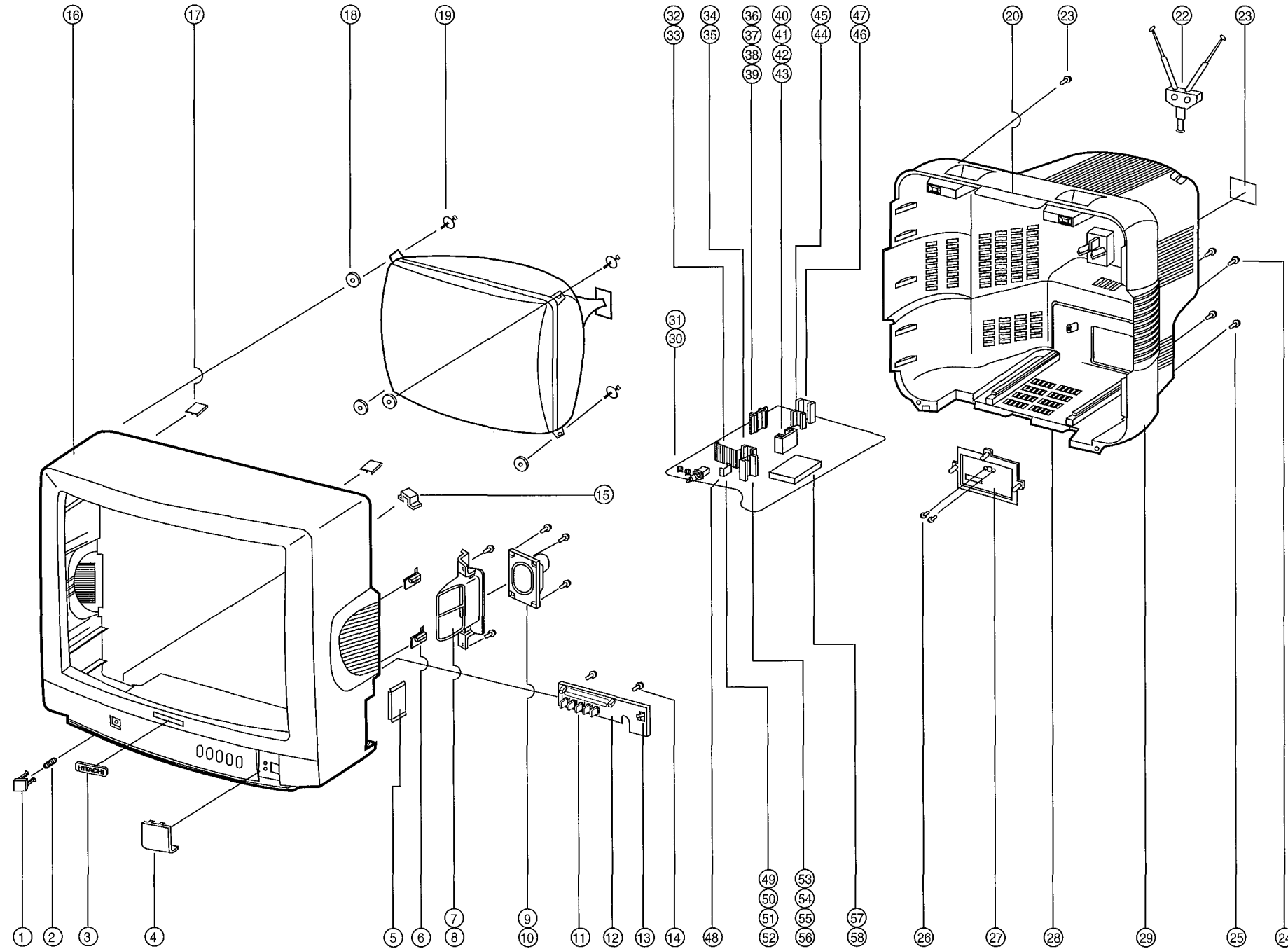

NO.	PART-CODE	PART-NAME	Q'TY	DESCRIPTION	REMARK
1	4854837301	BUTTON POWER	1	ABS BK	
2	4856717900	SPRING	1	SWPA	
3	4855615900	MARK BRAND	1	A1050P-H24 T0 4	
4	4855518901	DECO SENSOR	1	P C SMOG	
5	4852317602	PANEL A/V	1	HIPS BK	
6	4853743001	RETA	2	HIPS NC	
7	4853945201	BRKT SPKR	1	HIPS BK	
8	7122401411	SCREW TAPPING	2	T2S TRS 4x14 MFZN	RETA+BRKT
9	4858304920	SPEAKER	1	5W 8 OHM MSF-2D4SB53D	
10	7128301011	SCREW TAPPING	4	T2S WAS 3x10 MFZN	SPKT+BRKT
11	4854921101	BUTTON	1	ABS BK	
12		CONTROL PCB	1		
13	4853528101	LED HOLDER	1	HIPS BK	
14	7128301011	SCREW TAPPING	2	T2S WAS 3x10 MFZN	
15	4853525500	HOLDER CORD	1	FR HIPS BK	
16	4852046901	MASK FRONT	1	HIPS BK	
17	4853311601	RETAINER BACK	2	HIPS NC	
18	4856215402	WASHER RUBBER	4	CRT	
19	4856212000	SCREW CRT FIX	4	SWRM+SK-5 (L=30)	
20	4857817620	CLOTH BLACK	1	FELT TO 5 L=100	
21	7122401411	SCREW TAPPING	4	T2S TRS 4x14 MFZN	M/F+C/B
22	4850A02510	ANT ROD	1		
23	4855415800	SPEC PLATE	1	150ART P/E FILM	
24	7122401411	SCREW TAPPING	1	T2S TRS 4x14 MFZN	C/B+FBT
25	7122401411	SCREW TAPPING	3	T2S TRS 4x14 MFZN	C/B+TERM
26	7128261011	SCREW TAPPING	2	T2S WAS 2 6x10 MFZN	TERM+PLUG
27	4853624803	TERMINAL ANT	1	HIPS BK	
28	4852134400	COVER BACK	1	FR HIPS BK	
29	4857817620	CLOTH BLACK	4	FELT TO 5 L=100	
30	4857415001	CLIP FUSE	1	PFC5000-0702	
31	4857415001	CLIP FUSE	1	PFC5000-0702	
32	4857024400	HEAT SINK	1	AL EX	
33	7271301011	SCREW TAPPING	1	TT3 PAN 3x10 MFZN	
34	4857026900	SCREW TAPPING	1	T2S PANE 3x10 MFZN	
35	7121300811	SCREW TAPPING	1	TT3 PAN 3x10 MFZN	
36	4857024500	HEAT SINK	1	AL EX	
37	4856012310	SCREW SPECIAL	1	PAN 3x10 MFZN	
38	7392300011	NUT HEX	1	6N-2-3 MFZN	
39	4856215200	WASHER	1	PACC	
40	4857024603	HEAT SINK	1	AL EX	
41	4856012310	SCREW SPECIAL	1	PAN 3x10 MFZN	
42	7392300011	NUT HEX	1	6N-2-3 MFZN	
43	4856215200	WASHER	1	PSCC	
44	4857026900	HEAT SINK	1	AL EX	
45	7121301011	SCREW TAPPING	1	T2S PAN 3x10 MFZN	
46	4857024900	HEAT SINK	1	AL EX	
47	7121301011	SCREW TAPPING	1	T2S PAN 3x10 MFZN	
48		MAIN PCB	1		CP-330
49	4857025400	HEAT SINK	1	A1050P-H24 T2 0	
50	4856012310	SCREW SPECIAL	1	PAN 3x10 MFZN	
51	7392300011	NUT HEX	1	6N-2-3 MFZN	
52	4856215200	WASHER	1	SPCC	
53	4857024603	HEAT SINK	1	AL EX	
54	4856012310	SCREW SPECIAL	1	PAN 3x10 MFZN	
55	7392300011	NUT HEX	1	6N-2-3 MFZN	
56	4856215200	WASHER	1	SPCC	
57	4857235800	SHIELD CASE	1	SPTH-C T0 25	
58	4857235900	SHIELD PLATE	1	SPTH-C T0 25	

CHASSIS

SCHEMATIC DIAGRAM

* PAL - B/G

* PAL/SECAM - B/G
SECAM - L/L'

* PAL - I

WAVE FORMS

INPUT SIGNAL : PAL SYSTEM

VIDEO : 8 STEP COLOR BAR 875% AM

AUDIO : 1KHz SINE WAVE 60% FM

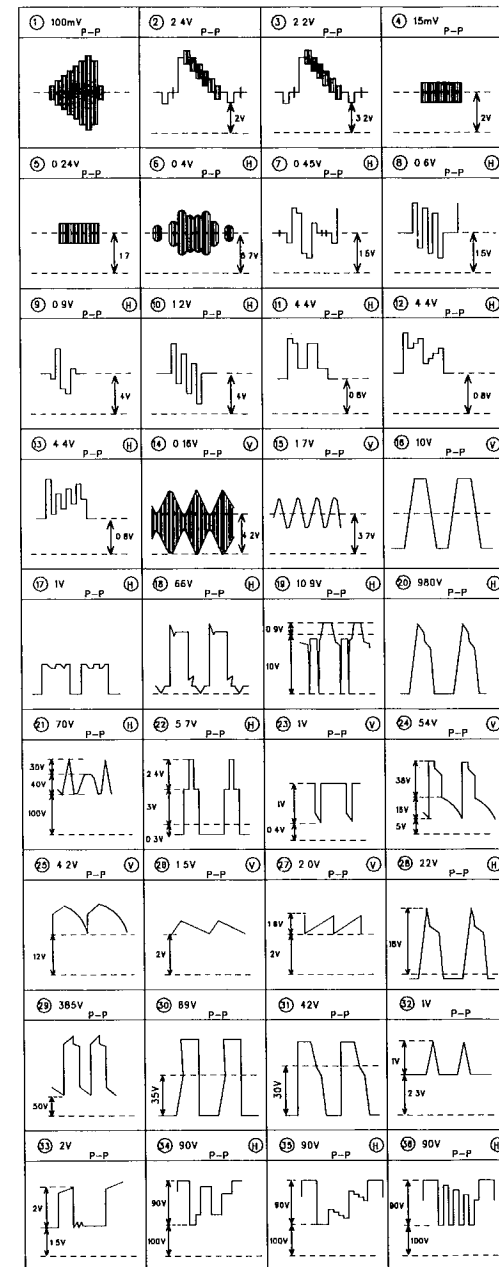

NOTES

- THE UNITS OF RESISTANCE 'OHM' IS OMITTED (K = 1000 OHMS M = 1000000 OHMS)
- ALL RESISTORS ARE 1/8 WATT UNLESS OTHERWISE NOTED
- CAPACITANCE VALUES 1.0 AND ABOVE ARE IN μF THOSE BELOW ARE IN nF EXCEPT AS INDICATED ($nF = 1000000 pF$)
- INDUCTOR VALUES ARE IN μH EXCEPT AS INDICATED
- ALL DIODES ARE 1N4148 EXCEPT AS INDICATED
- ALL NPN TRANSISTORS ARE KTC3198Y ALL PNP TRANSISTERS ARE KTA1266Y EXCEPT AS INDICATED
- DC VOLTAGE AND AC WAVEFORM MEASUREMENT CONDITIONS
ALL THE VOLTAGES IN EACH POINT ARE MEASURED UNDER THE STANDARD COLOUR BAR SIGNAL INPUT (5 CHANNEL) AND ALL CONTROLS SET TO THE MAXIMUM POSITION
(DC VOLTAGES WITH VTVM AND AC WAVEFORMS WITH OSCILLOSCOPE)
(FOR A NOMINAL LINE VOLTAGE : AC 230V 50HZ)
- SINCE THIS SCHEMATIC DIAGRAM IS A STANDARD ONE THE CIRCUIT AND CIRCUIT CONSTANTS MAY BE SUBJECT TO CHANGE FOR IMPROVEMENT WITHOUT ANY NOTICE

SAFETY CAUTION

BEFORE SERVICING THIS CHASSIS IT IS IMPORTANT THAT THE SERVICE TECHNICIAN READ AND FOLLOW THE 'X-RAY RADIATION PRECAUTION', 'SAFETY PRECAUTIONS' AND 'PRODUCT SAFETY NOTICE' IN THE SERVICE MANUAL

PRODUCT SAFETY NOTE

COMPONENTS MARKED WITH A Δ ARE IMPORTANT FOR MAINTAINING THE SAFETY OF THE SET AND SHOULD BE REPLACED ONLY WITH TYPES IDENTICAL TO THOSE IN THE ORIGINAL OR SPECIFIED ONE IN THE PARTS LIST
DON'T DEGRADE THE SAFETY OF THE SET THROUGH IMPROPER SERVICING

DIFFERENT PARTS FOR SYSTEM (1)

NO	LOC	P-B/G	P/S-B/G S-L/L'	P-I	REMARK
1	VT101	TEKE-005B(120A) TECC2889VA15C	TECC2889VA15C	DT2-IV15P	
2	SF101	G1968M		J1951W	
3	Z701	TPS5.5MB		TPS6.0MB	
4	Z801	SFE5.5MB		SFE6.0MB	
5	IS02	X	TDAB395	X	
6	I701	TDA0362B	TDAB362	TDAB362B	
7	P801A	CW-4232		CW-3222	
8	C105	10u	33u		
9	C107	4.7u		X	
10	C108	0.01		X	
11	C109	4.7u		X	
12	C110	0.01		X	
13	C111	4.7u		100u	
14	J801	JUMPER	X	JUMPER	
15	J802	JUMPER	X	JUMPER	
16	R108	18K		JUMPER	
17	R110	X	1/4W 1.8M	1/4W 8.2M	
18	R113	470	220	470	
19	CA01	X	10u	X	
20	DA01	X	1N4148	X	
21	IA01	X	4053	X	
22	QA01	X	KTC3198Y	X	
23	QA02	X	KTA1266Y	X	
24	QA03	X	KTC3198Y	X	
25	RA01	X	47K	X	
26	RA02	X	10K	X	
27	RA03	X	10K	X	
28	RA04	X	22K	X	
29	RA05	X	10K	X	
30	RA06	X	47K	X	
31	RA07	X	1K	X	
32	RA08	X	1/4W 1	X	
33	RA09	X	820K	X	
34	CL02	X	0.01	X	
35	CL03	X	33u	X	
36	CL04	X	4.7u	X	
37	CL05	X	4.7u	X	
38	CL06	X	1u	X	
39	CL07	X	2200	X	
40	CL08	X	10	X	
41	CL09	X	TZ03R300B	X	
42	CL12	X	25V	X	
43	DL01	X	IS2186	X	
44	DL02	X	IS2186	X	
45	DL03	X	1N4148	X	
46	DL04	X	IS2186	X	
47	DL05	X	1N4148	X	
48	DL06	X	1N4148	X	
49	DL08	X	1N4148	X	
50	HL01	X	TDA3843	X	
51	LL01	X	10uH	X	
52	LL02	X	10uH	X	
53	QL01	X	KTC3198Y	X	
54	QL02	X	KTC3198Y	X	
55	QL03	X	KTC3198Y	X	
56	QL04	X	KTC3198Y	X	
57	QL05	X	KTC3198Y	X	
58	QL06	X	KTC3198Y	X	
59	SL01	X	L9461M	X	
60	RL01	X	2.2K	X	
61	RL02	X	10K	X	
62	RL03	X	10K	X	
63	RL04	X	10K	X	
64	RL05	X	22K	X	

NO	LOC	P-B/G	P/S-B/G S-L/L'	P-I	REMARK
65	RL06	X	68K	X	
66	RL07	X	3K	X	
67	RL08	X	1K	X	
68	RL09	X	1K	X	
69	RL10	X	4.7K	X	
70	RL11	X	39K	X	
71	RL12	X	100K	X	
72	RL13	X	4.7K	X	
73	RL14	X	22K	X	
74	RL15	X	39K	X	
75	RL17	X	4.7K	X	
76	RL24	X	22K	X	
77	RL25	X	43K	X	
78	RL26	X	4.7K	X	
79	CU01	X	X	1000	
80	CU02	X	X	1000	
81	CU03	X	X	100	
82	CU04	X	X	100	
83	DV08	X	X	1N4148	UHF only
84	DV09	X	1N4148	X	NO TEXT
85	DV12	X	1N4148	X	SECAM-L
86	DV13	X	1N4148	X	LIST
87	QV03	X	KTA1266Y	X	
88	QV04	X	KTA1266Y	X	
89	RV29	X	4.7K	X	
90	RV30	X	4.7K	X	
91	DT05	X	1N4148	X	
92	IT01	X	SAAS281PE	X	
93	IT02	X	KA2186	X	
94	XT01	X	27MHz	X	27MHz
95	Z101	X	40.4MHz TRAP	X	
96	Z102	X	40.4MHz TRAP	X	

DIFFERENT PARTS FOR SIZE (2)

NO	LOC	14"			20"			21"		
		ORION	PHILIPS	POLKOLOR	ORION	SAMSUNG	POLKOLOR	ORION	PHILIPS	POLKOLOR
1	CRT	A34JLL90X	A34EAC01X	A33FFU03X	A48JL190X	A48ECR31X	A48EEV33X	A51J5W90X	A51EAL55X	A51EBV13X
2	CRT SOCKET	ISW-01S		ISH-04S	ISM-03S	ISH-04S		ISM-03S	ISH-04S	
3	D/COIL	DC-1450			DC-2050			DC-2070		
4	T402	1142.5037	1142.5034	1142.5025	1142.5037	FSA-17013M	1142.5056	DCF-2217L	FSA-17013M	
5	C409	1.6KV 8000	1.6KV 6200	1.6KV 8000	1.6KV 7500	1.6KV 8200		1.6KV 7500	1.6KV 8200	1.6KV 7500
6	C410	2KV 470	X	2KV 220	X	2KV 1000	X	2KV 680	2KV 470	X
7	C411	200V 0.33u	200V 0.51u					200V 0.36u	200V 0.47u	
8	L403	L-125	L-76			L-62	L-76	L-102	L-76	
9	L405	AZ-9004Y			JUMPER					
10	R411	1/2W 180K			1/2W 120K					
11	R421	2W 2.4 (f)	1W 2.2 (f)	1W 0.88(f)	2W 2.4 (f)	2W 2.7 (f)	1W 1.0 (f)	1W 6.2 (f)	1W 6.8 (f)	2W 2.4 (1)
12	R423	2W 56			JUMPER					
13	R501	2W 9.1K			2W 12K					
14	R511	2W 9.1K			2W 12K					
15	R521	2W 9.1K			2W 12K					
16	RV09	2.2K			2.7K					
17	RV17	11K			4.7K					
18	R801	ECFAC 160M270						J503P530 140M290L		

CAPACITOR

ELECTRO	— —
CERAMIC	— —
CERAMIC CH	— — (CH)
TANTAL	— — (T)
ELECTRO NONPOLAR	— — (NP)
MYLAR	— — (M)

RESISTOR

CARBON FILM	—W—
M-OXIDE FILM	—W— (M)
CARBON COMP	—W— (CC)
FUSIBLE	—W— (f)
CEMENT	—W— (C)

COIL

PEAKING	—W—
CHOKER	—W— (C)
BEAD	—W— (B)

HITACHI

HITACHI LTD. TOKYO JAPAN
International Sales Division,
THE HITACHI ATAGO BLDG.
No. 15 -12 Nishi-Shinbashi, 2 - Chome,
Minato-Ku, Tokyo 105, Japan
Tel. Tokyo 3 32581111

HITACHI SALES EUROPA GmbH
Am Seestern 18,
40547 Düsseldorf,
Germany
Tel. 0211 5291 50

HITACHI SALES (HELLAS) S.A.
91, Falirou Street, 117-41 Athens,
Greece
Tel. 92 42-620-4

HITACHI HOME ELECTRONICS (EUROPE) Ltd.
Hitachi House, Station Road, Hayes,
Middlesex UB3 4DR,
England
Tel. 0181 849 2000

HITACHI SALES IBERICA, S.A.
Gran Via Carlos Tercero.101,1 -1
Barcelona 08028
Tel. 3- 330.86.52

HITACHI FRANCE (RADIO-T.V.-ELECTRO-MENAGER) S.A.
4, allée des Sorbiers,
Parc d'active de Chêne,
69671 BRON Cedex,
France
Tel. 72 14-29-70

HITACHI HOME ELECTRONICS NORDIC
Domnarvsgatan 29 Lunda, Box 62
S-163 91 Spanga,
Sweden
Tel. 08 621 8250

**Scan & PDF-Design: Schaltungsdienst
Lange oHG
Verlag technische Druckschriften**

**Zehrendorfer Straße 11
D-12277 Berlin**

<http://www.schaltungsdienst.com>